

ONE STAGE LIGHT OIL BURNERS

▶ RIELLO 40 G SERIES

▶ G3	23,8 ÷ 35,5 kW
▶ G3R	23,8 ÷ 35,5 kW
▶ G3RK	15,0 ÷ 35,0 kW
▶ G5	28,0 ÷ 60,0 kW
▶ G5R	28,0 ÷ 60,0 kW
▶ G5RK	12,0 ÷ 60,0 kW
▶ G7	29,0 ÷ 69,0 kW
▶ G10	54,0 ÷ 120,0 kW
▶ G20	95,0 ÷ 213,0 kW
▶ G20S	95,0 ÷ 240,0 kW



The Riello 40 G series of one stage light oil burners, is a complete range of products developed to respond to any request for home heating. The Riello 40 G series is available in eleven different models, with an output ranging from 12 to 240 kW, divided in four different structures.

All the models use the same components designed by Riello for the Riello 40 G series. The high quality level guarantees safe working.

In developing these burners, special attention was paid to reducing noise, to the ease of installation and adjustment, to obtaining the smallest size possible to fit into any sort of boiler available on the market.

All the models are approved by the EN 267 European Standard and conform to European Directives for EMC, Low Voltage, Machinery and Boiler Efficiency.

All the Riello 40 G burners are fired before leaving the factory.

TECHNICAL DATA

Model		▼ G3	▼ G3R	▼ G3RK	▼ G5	▼ G5R	▼ G5RK	▼ G7	▼ G10	▼ G20	▼ G20S	
Burner operation mode		One stage						One stage				
Modulation ratio at max.output		--						--				
Servomotor	type	--						--				
	run time	s						--				
Heat output	kW	23,8 - 35,5	23,8 - 35,5	15 - 35	28 - 60	28 - 60	12 - 60	29 - 69	54 - 120	95 - 213	95 - 240	
	Mcal/h	20,4 - 30,5	20,4 - 30,5	12,9 - 30,1	24,1 - 51,6	24,1 - 51,6	10,3 - 51,6	24,9 - 59,3	46,4 - 103,2	81,7 - 183,2	81,7 - 206,4	
	kg/h	2 - 3	2 - 3	1,3 - 3	2,3 - 5	2,3 - 5	1 - 5	2,5 - 5,8	4,5 - 10	8 - 18	8 - 20	
Working temperature	°C min./max.	0/40						0/40				
Net calorific value	kWh/kg	11,8						11,8				
	kcal/kg	10200						10200				
Viscosity	mm ² /s (cSt)	4 + 6 (at 20°C)						2 + 6 (at 20°C)		4 + 6 (at 20°C)		
Pump	type	R.B.L.						R.B.L.				
	delivery	kg/h						30 (at 12 bar)				
Atomised pressure	bar	8 - 15						8 - 15				
Fuel temperature	max. °C	50						50				
Fuel pre-heater		NO	YES	YES	NO	YES	YES	NO	NO	NO	NO	
Fan	type	Centrifugal with forward curve blades						Centrifugal with forward curve blades				
Air temperature	max. °C	40						40				
Electrical supply	Ph/Hz/V	1/50/230 ±10%						1/50/230 ±10%				
Aux. electrical supply	Ph/Hz/V	--						--				
Control box	type	RBL 530 SE	RBL 531 SE	RBL 531 SE	RBL 530 SE	RBL 531 SE	RBL 531 SE	RBL 530 SE	RBL 530 SE	RBL 530 SE	RBL 530 SE	
Total electrical power	kW	0,115	0,165	0,170	0,130	0,185	0,185	0,160	0,170	0,320	0,330	
Aux. electrical power	kW	--						--				
Heaters electrical power	kW	--	0,055	0,055	--	0,055	0,055	--	--	--	--	
Protection level	IP	X0D (IP 40)						X0D (IP 40)				
Pump motor electrical power	kW	--						--				
Rated pump motor current	A	--						--				
Pump motor start up current	A	--						--				
Pump motor protection level	IP	--						--				
Fan motor electrical power	kW	0,09	0,09	0,09	0,09	0,09	0,09	0,09	0,09	0,15	0,15	
Rated fan motor current	A	0,7	0,7	0,7	0,75	0,75	0,75	0,85	0,8	1,4	1,5	
Fan motor start up current	A	2,8	2,8	2,8	3	3	3	3,4	3,2	5,6	6	
Fan motor protection level	IP	20						20				
Ignition transformer	type	Incorporated in the control box						Incorporated in the control box				
	V1 - V2	(--) - 8 kV						(--) - 8 kV				
	I1 - I2	(--) - 30 mA						(--) - 30 mA				
Operation		Intermittent (at least one stop every 24 h)						Intermittent (at least one stop every 24 h)				
Sound pressure	dB(A)	57	57	56	59	59	59	64	65	74	72	
Sound power	W	--						--				
CO emission	mg/kWh	16	11	40	10	10	20	15	15	20	20	
Grade of smoke indicator	N° Bacharach	<1						<1				
CxHy emission	mg/kWh	<10 (after the first 20s)						<10 (after the first 20s)				
NOx emission	mg/kWh	170	160	160	180	185	175	180	190	180	190	
Directives		89/336 (2004/108)EC, 73/23/EC, 98/37/EC, 92/42/EC				89/336 (2004/108)EC, 73/23/EC, 89/336 (2004/108)EC, 73/23/EC,		89/336 (2004/108)EC, 73/23/EC, 89/336 (2004/108)EC, 73/23/EC,		89/336 (2004/108)EC, 73/23/EC, 98/37/EC, 92/42/EC		
Conforming to		EN 267						EN 267				
Certification		--	--	CE-0036 0254/99	--	--	CE-0036 0256/99	--	CE-0036 0257/99	--	--	

Reference conditions:
 Temperature: 20 °C
 Pressure: 1013 mbar
 Altitude: 0 m a.s.l.
 Noise measured at a distance of 1 meter.

Since the Company is constantly engaged in the production improvement, the aesthetic and dimensional features, the technical data, the equipment and the accessories can be changed.
 This document contains confidential and proprietary information of RIELLO S.p.A. Unless authorised, this information shall not be divulged, nor duplicated in whole or in part.

FIRING RATES

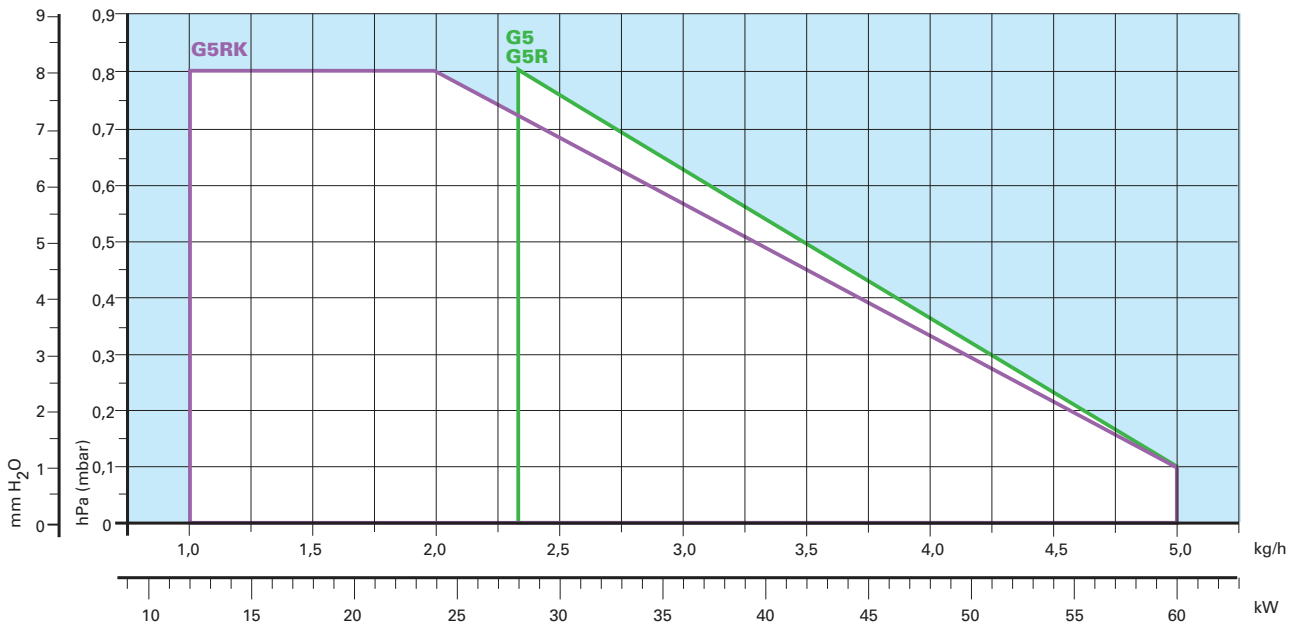
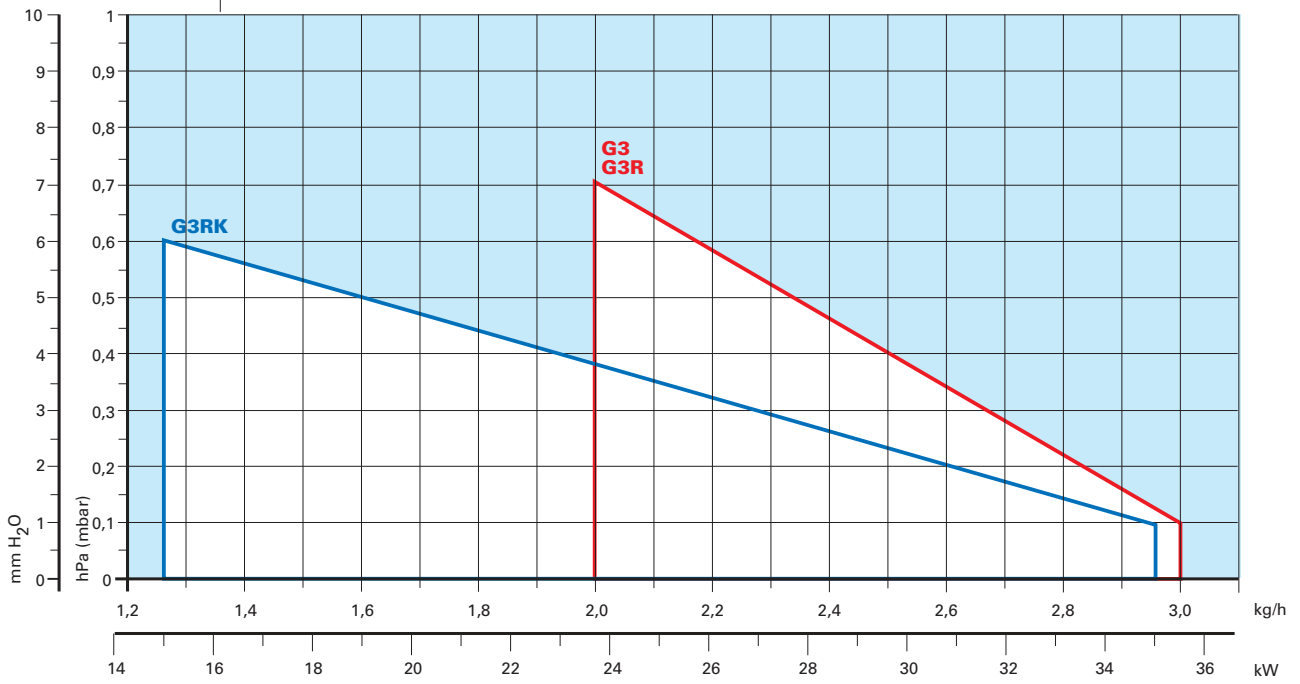

Useful working field for choosing the burner

Test conditions conforming to EN 267:

Temperature: 20°C
 Pressure: 1013 mbar
 Altitude: 0 m a.s.l.

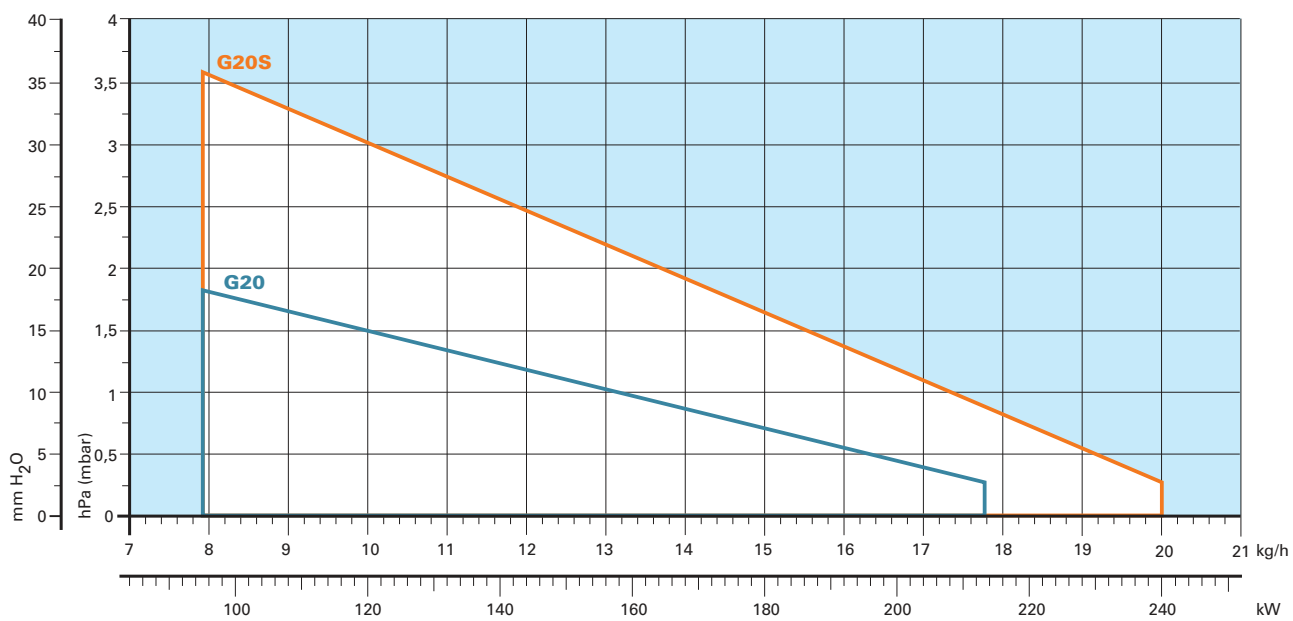
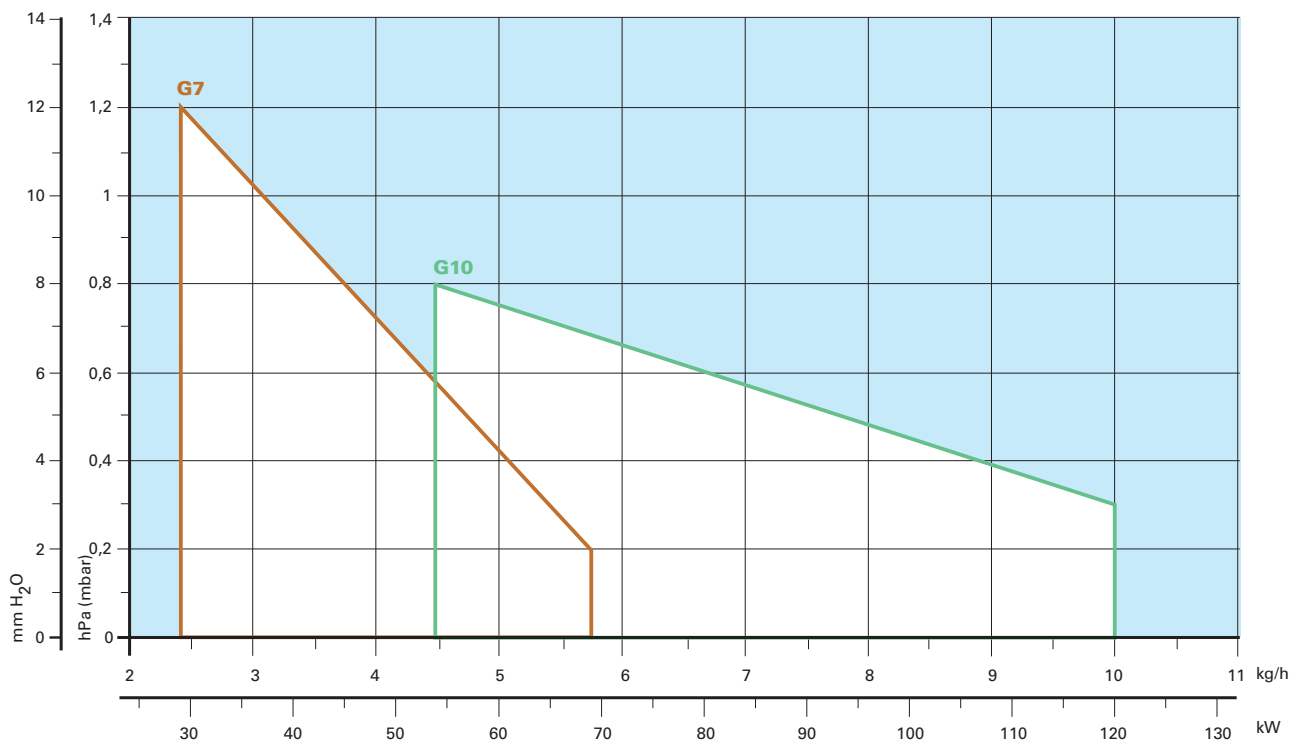

Useful working field for choosing the burner

Test conditions conforming to EN 267:

Temperature: 20°C
 Pressure: 1013 mbar
 Altitude: 0 m a.s.l.



FUEL SUPPLY

HYDRAULIC CIRCUIT

All the burners have a R.B.L. geared pump with safety valve on the return circuit.



Fuel pump

G3 - G3R - G3RK - G5 - G5R - G5RK - G7 - G10 - G20

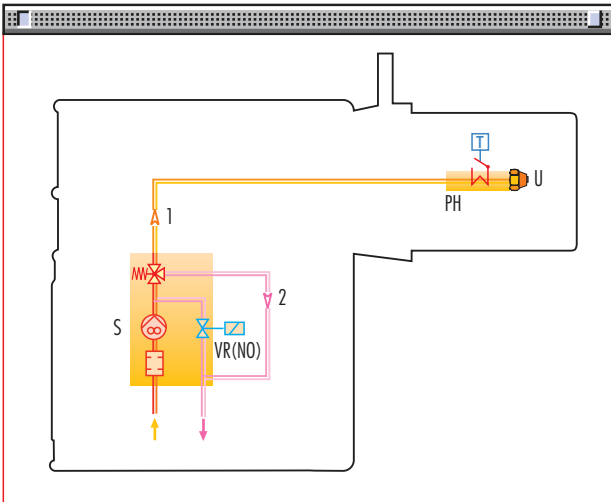

Fuel feed to the burner can be from the right or the left side on all models.

G20S

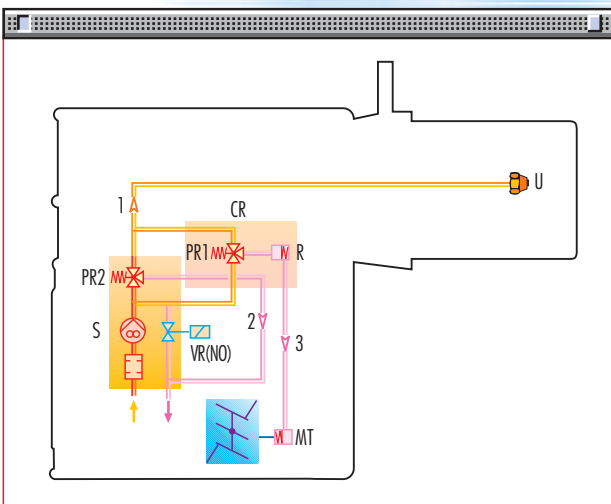

S	Pump with filter and pressure regulator on the delivery pipe
VR(NO)	Oil return valve on the delivery pipe
1	Oil input pipe to the nozzle
2	Oil return pipe from the regulator
3	Oil delivery pipe to the air damper hydraulic jack
MT	Air damper hydraulic jack for high pressure working
PR1	Low pressure oil regulator
PR2	High pressure oil regulator
R	Delayer
CR	Delayer casing
PH	Oil pre-heater with thermostat (where provided)
U	Nozzle

LIGHT OIL PRE-HEATER

The models "R" have light oil pre-heater which is located next to the nozzle, operated by the control box which delays burner ignition before each start in order to adequately pre-heat the oil.



SELECTING THE FUEL SUPPLY LINES

The fuel feed must be completed with the safety devices required by the local regulations in force.

The table shows the choice of piping diameter for the various burners, depending on the difference in the height between the burner and the tank and the distance between them.

MAXIMUM EQUIVALENT LENGTH OF THE PIPEWORK L[m]				
Pipe size	▼ Type A system		▼ Type B system	
	Ø8mm	Ø10mm	Ø8mm	Ø10mm
H (m)	L _{max} (m)	L _{max} (m)	L _{max} (m)	L _{max} (m)
0	35	100	-	-
0,5	30	100	10	20
1,0	25	100	20	40
1,5	20	90	40	80
2,0	15	70	60	100
3,0	8	30	-	-
3,5	6	20	-	-

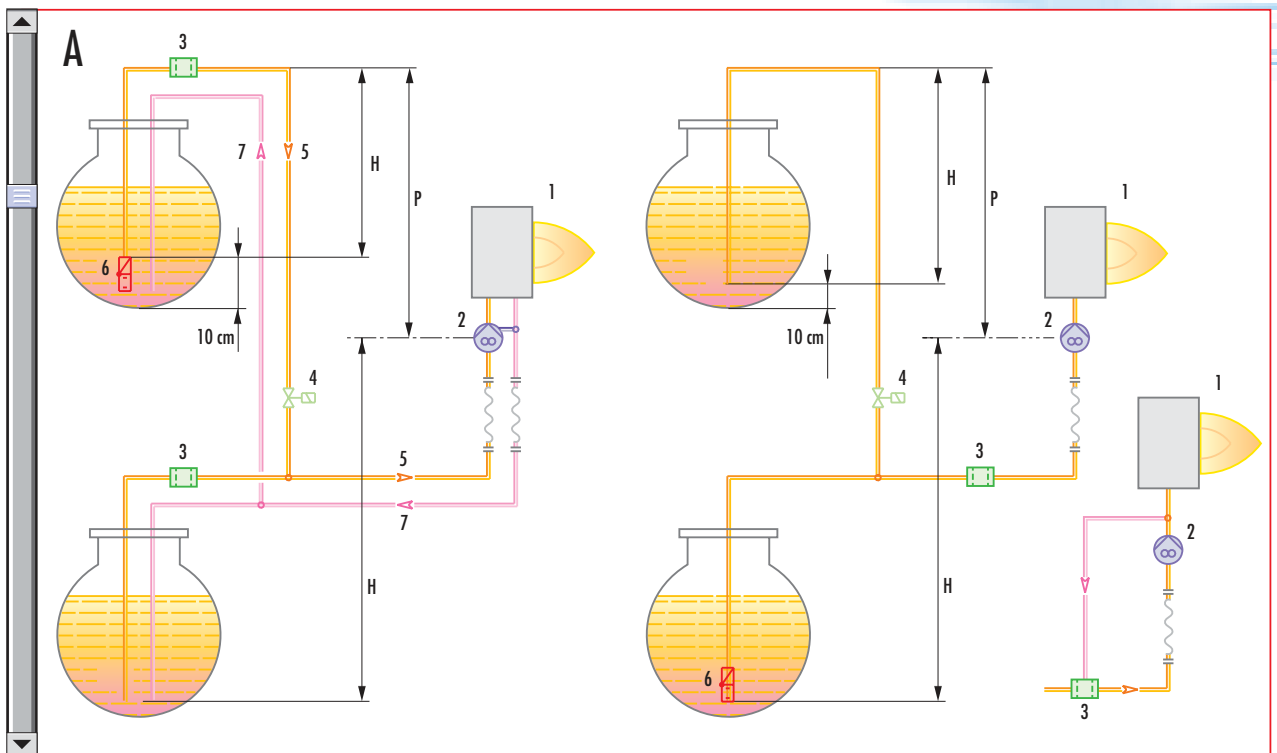

Type of system that can be installed

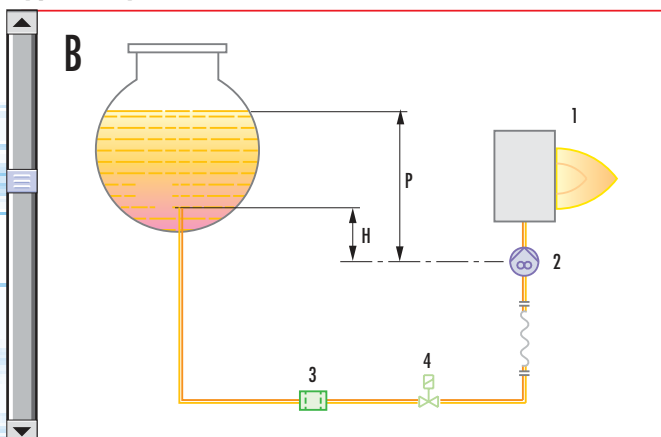

H	Difference in height
Ø	Internal pipe diameter
P	Difference in height ≤ 4 m
1	Burner
2	Pump
3	Filter
4	Shut-off solenoid valve
5	Suction pipework
6	Bottom valve
7	Return pipework



VENTILATION

The ventilation circuits always ensure low noise levels with high performance of pressure and air delivery, inspite of their compact size.



Air suction

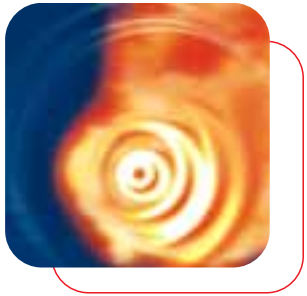

COMBUSTION HEAD

The G3 and G3R models all have fixed heads. Certain models allows you to choose the length of the combustion head.

This choice depends on the thickness of the front wall and type of the boiler.

Depending on the type of generator, you should check the correct penetration of the head into the combustion chamber.

Simple adjustment to the combustion head allows adapting internal geometry of the head to the maximum rated output of the burner.



Combustion head

Dimensions of the flame

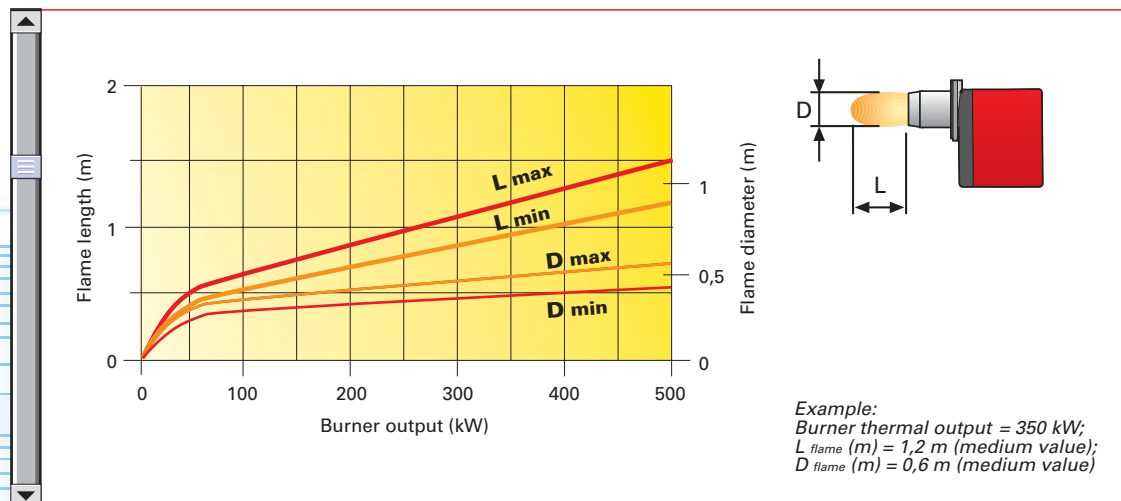

OPERATION



BURNER OPERATION MODE

All these models are one stage operation; the G20S model is one stage operation with reduced output firing.



Air damper

One stage operation

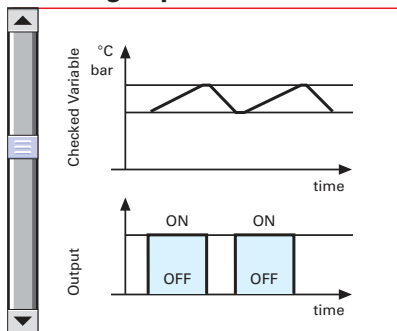

One stage operation with reduced output ignition

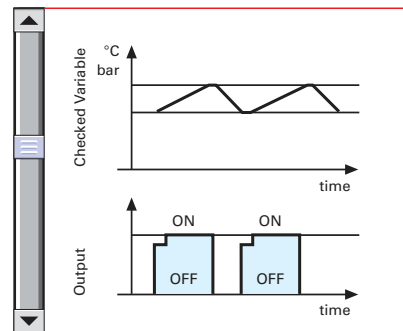

START UP CYCLE

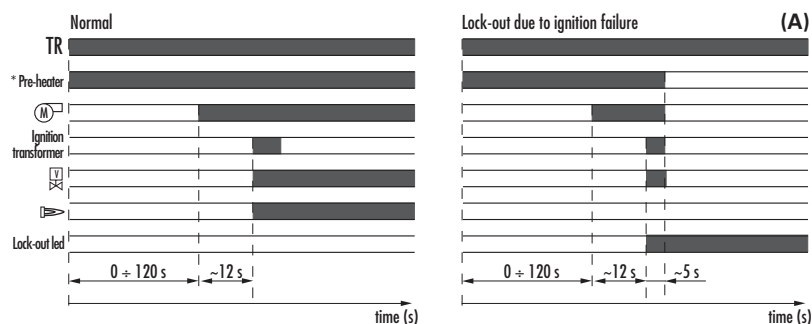

* Only model with pre-heater.

(A) Lock-out is shown by a led on the appliance.

Correct operation

- 0s The burner begins the ignition cycle.
- 0s-12s Pre-purge with the air damper open.
- 12s Ignition.

* If the pre-heater is fitted (G...R series), there is a further delay before pre-purge; this delay can reach 120s depending on room and fuel temperatures.

Lock-out due to ignition failure

If the flame does not light within the safety limit (~ 5s) the burner locks-out.



WIRING DIAGRAMS

Electrical connections must be made by qualified and skilled personnel in conformity with the local regulations in force.



Control box fitted with an ignition transformer

“ONE STAGE” OPERATION

G3 - G3R - G5 - G5R - G7 - G20 - G20S

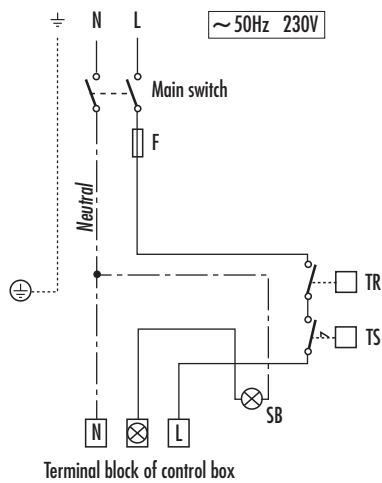

TR - Regulating thermostat
TS - Safety thermostat (with manual resetting)
SB - Remote lock-out lamp (230V 0,5A max)
F - Fuse

G3RK - G5RK - G10

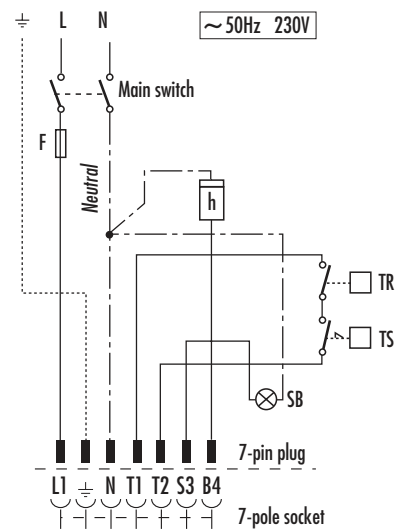

TR - Regulating thermostat
TS - Safety thermostat (with manual resetting)
SB - Remote lock-out lamp (230V 0,5A max)
h - Hour meter
F - Fuse

The following table shows the supply lead sections and types of fuse to be used.

Model	▼ G3	▼ G3R	▼ G3RK	▼ G5	▼ G5R	▼ G5RK	▼ G7	▼ G10	▼ G20	▼ G20S
F A	6	6	6	6	6	6	6	6	T6	T6
L mm ²	1	1	1	1	1	1	1	1	1	1

F = Fuse L = Lead section

EMISSIONS

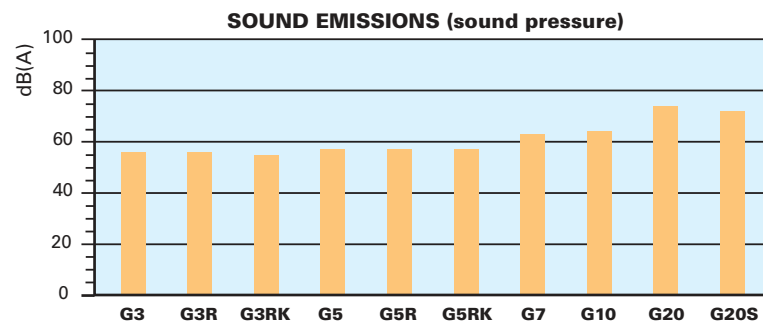
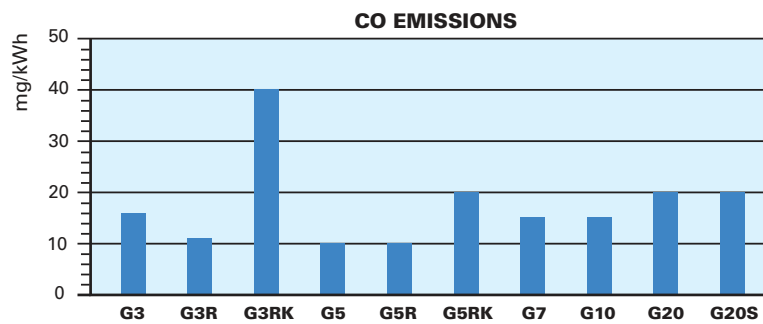
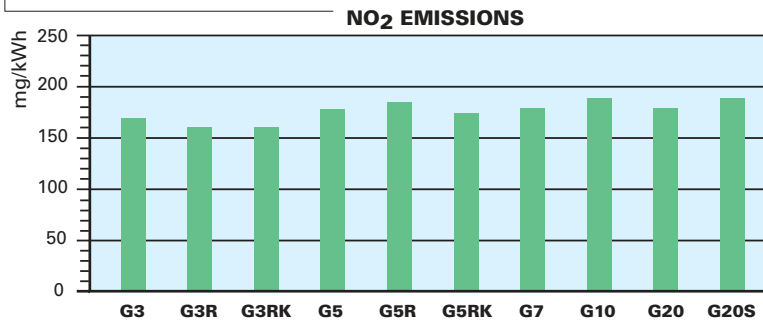

The emission data have been measured in the various models at maximum output, in conformity with EN 267 standard.

Special attention has been paid to noise reduction. All models are fitted with sound-proofing material inside the cover.





OVERALL DIMENSIONS (mm)

These models are distinguished by their reduced size, in relation to their outputs, which means they can be fitted to any boiler on the market.

BURNER

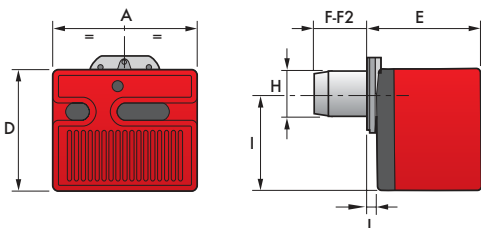

Model	A	D	E	F	F2	H	I	L
▶ G3	252	215	203	86	-	89	164	19
▶ G3R	252	215	203	86	-	89	164	19
▶ G3RK	252	215	203	97	115	89	164	19
▶ G5	272	233	236	107	-	89	180	37
▶ G5R	272	233	236	107	-	89	180	37
▶ G5RK	272	233	236	94	112	89	180	37
▶ G7	305	262	261	73	-	89	204	40
▶ G10	305	262	261	108	-	105	204	40
▶ G20	350	298	295	118	-	125	230	41
▶ G20S	350	298	295	118	-	125	230	41

BURNER-BOILER MOUNTING FLANGE

G3 - G3R - G3RK - G5 - G5R - G5RK - G7 - G10

G20 - G20S

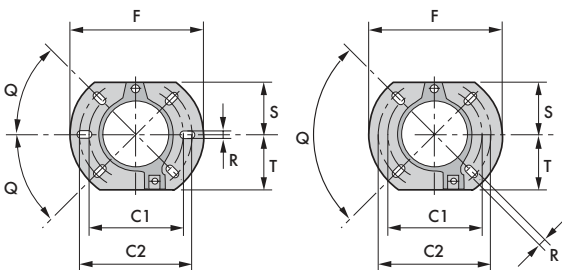

Model	C1	C2	F	Q	R	S	T
▶ G3 - G3R - G3RK - G5 - G5R - G5RK	130	150	180	45	11	72	75
▶ G7 - G10	140	170	189	45	11	83	83
▶ G20 - G20S	160	190	213	90	11	99	99

PACKAGING

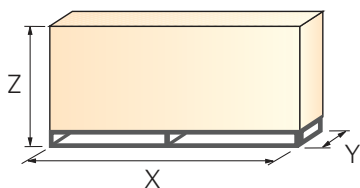

Model	X	Y	Z	kg
▶ G3	363	295	310	10
▶ G3R	363	295	310	10
▶ G3RK	363	295	310	10,5
▶ G5	383	315	325	12
▶ G5R	383	315	325	12
▶ G5RK	383	315	325	12
▶ G7	423	348	340	13
▶ G10	423	348	340	13,5
▶ G20	483	393	377	16
▶ G20S	483	393	377	17,5

INSTALLATION DESCRIPTION

Skilled and qualified personnel must perform installation, start up and maintenance. A nozzle is fitted to the burner and used for fire tests in the factory. If necessary, change the nozzle on the basis of the maximum output of the boiler.
All operations must be carried in accordance with the technical handbook supplied with the burner.



BURNER SETTING

- ▶ Air damper and head adjustment area are easily accessible and the operation is simple thanks to a graduated scale and following the manual instruction.



- ▶ The pressure regulator is carried out by setting the adjustment screw.



ELECTRICAL CONNECTIONS AND MAINTENANCE

- ▶ Electrical wirings are easily thanks to plug and socket connections. The 7 pin plug is supplied for connection to the boiler.





BURNER ACCESSORIES

Extended head kit

Kits of extended heads are available.

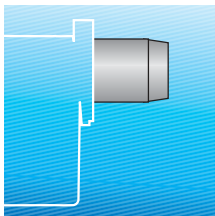

Extended head kit			
Burner	Standard head length (mm)	Extended head length (mm)	Kit code
G5, G5R	107	121	3000686
G5, G5R	107	121 INOX	3000687
G5, G5R	107	94÷112 (conic head)	3000726
G10	108	168	3000643
G10	108	250	3000770
G20, G20S	118	178	3000644
G20, G20S	118	260	3000771

Spacer kit

Using the special accessories, the burner can be pulled back to reduce head penetration into the combustion chamber.

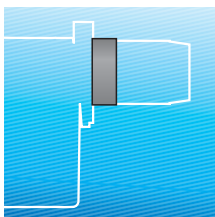

Spacer kit		
Burner	Spacer thickness S (mm)	Kit code
G3, G3R, G3RK, G5, G5R, G5RK, G7	25	3000642
G10	25	3000672
G20, G20S	25	3000673

Light oil filter

For cleaning light oil from dirty particles and impurities filters with the following features are available:



Light oil filter		
Burner	Filtering degree (µm)	Code
All models	60	3006561

Filter made up of aluminium body and stainless steel filtering cartridge; available singularly.

Light oil filter		
Burner	Filtering degree (µm)	Code
All models	60	3075011

Filter made up of aluminium cover, plastic tank and nylon filtering cartridge; available in packaging of 50 pieces.

Light oil filter/degassing unit

To solve problems of air or water in the oil circuit a special filter/degassing unit is available, made up of aluminium cover, plastic tank, stainless steel filtering cartridge, air release cap and water purge valve. It is available singularly.



Light oil filter/degassing unit		
Burner	Filtering degree (µm)	Code
All models	100	3000926



Biodiesel kit

Biodiesel kit	
Burner	Kit code
G3, G3R, G3RK, G5, G5R, G5RK, G7, G10, G20	3000978
G20S	3000979

FAME according to EN 14213

7-pin plug kit

If necessary a 7-pin plug kit is available (in packaging of n. 5 pieces).

7-pin plug kit	
Burner	Code
All models	3000945

Remote control release kit for 530-531 SE control boxes

The 530-531 SE control boxes can be remotely released using an electric command kit. This kit must be installed in conformity with current regulations in force.

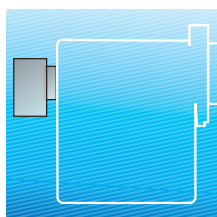

Remote control release kit for 530-531 SE control boxes	
Burner	Kit code
All models	3001030

Hour counter kit for 530 SE and 531 SE control boxes

To measure the burner working time a hour counter kit is available.

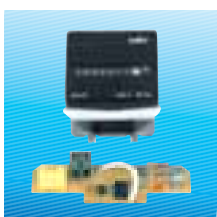

Hour counter kit for 530 SE and 531 SE control boxes	
Burner	Kit code
All models	3000904

7-pole socket kit for 530 SE and 531 SE control boxes

For the burner without pre installed socket a 7-pole socket kit with cable is available.

Hour counter kit for 530 SE and 531 SE control boxes	
Burner	Kit code
All models	3001065



BALANCED FLUE VERSION

The Riello 40 series balanced flue oil burner has been specifically designed to meet the increasing trend towards the use of balanced flue, otherwise known as room sealed appliances, which avoids the necessity of having a chimney to discharge the products of combustion.

Balanced flue products are completely sealed from the environment in which they are installed, drawing air for combustion directly from the outside, thereby ensuring no unwelcome smells from combustion of the oil.

As a result of the burner components such as motor, oil pump etc. being completely enclosed this provides an additional benefit of low sound levels.

The Riello 40 balanced flue range has been designed and manufactured to meet the latest European and OFTEC test requirement and are manufactured under quality assurance standards.

Riello 40 balanced flue version is available for the following models: G3, G3R, G3RK, G5, G5R, G5RK.



Riello 40 balanced flue version

Overall dimensions (mm)

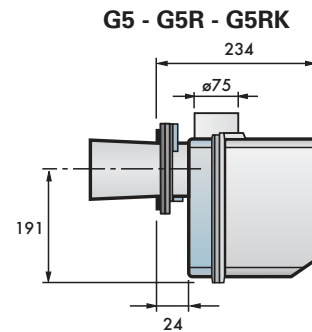
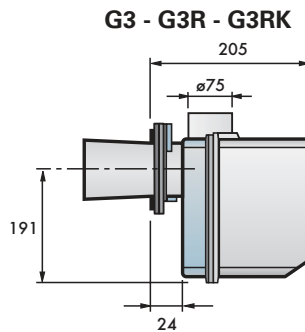
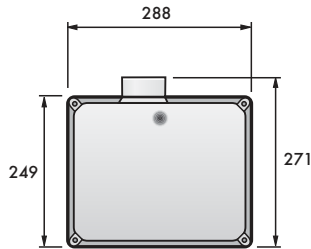

SPECIFICATION



A special index will help you choose the right burner from the Riello 40 G models available. There is also a clear and detailed product specification and description.

DESIGNATION OF SERIES

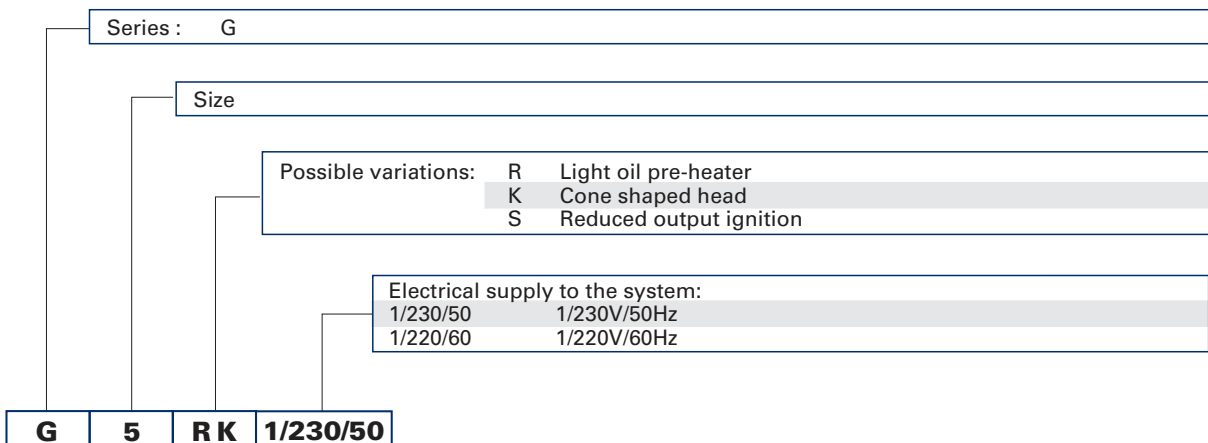



▶ AVAILABLE BURNER MODELS

G3	1/230/50	G10	1/230/50
G3R	1/230/50	G20	1/230/50
G3RK	1/230/50	G20S	1/230/50
G5	1/230/50	G10	1/220/60
G5R	1/230/50	G20	1/220/60
G5RK	1/230/50	G20S	1/220/60
G7	1/230/50		

▶ PRODUCT SPECIFICATION

Burner:

Completely automatic monobloc light oil burners, with one stage operation fitted with:

- Fan with forward inclined blades
- Metallic cover lined with sound-proofing material
- Air damper, completely closed in stand by, with adjustment
- Single phase electric motor 230 V, 50 Hz
- Combustion head fitted with:
 - stainless steel head cone, resistant to high temperatures
 - ignition electrodes
 - flame stability disk
- Geared pump for fuel supply, fitted with:
 - filter
 - pressure regulator
 - attachments for fitting a pressure gauge and vacuum meter
 - internal by-pass for preparing for single-pipe installations
- Fuel feed solenoid valve incorporated in the pump
- Photocell for flame detection
- Electronic flame control equipment
- Light oil nozzle
- IP X0D (IP 40) protection level
- Fuel pre-heater (optional)
- Reduced output ignition mechanism (optional).

Approval:

- EN 267 standard.

Conforming to:

- Directive 89/336 (2004/108)EC (electromagnetic compatibility)
- Directive 73/23/EC (low voltage)
- Directive 98/37/EC (machinery)
- Directive 92/42/EC (efficiency).

Standard equipment:

- Two flexible pipes for connection to the light oil supply line
- Two nipples for connection to the pump
- Flange, screws and nuts for fixing
- Thermal screen
- 7-pin plug (on request)
- Maintenance assembly
- Instruction handbook for installation, use and maintenance
- Spare parts catalogue.

Available accessories to be ordered separately:

- Extended head kit
- Spacer kit
- Light oil filter
- Biodiesel kit
- Remote control release kit for 530-531 SE control boxes
- Balanced flue version
- 7-pin plug kit
- Hour counter kit for 530 and 531 control boxes
- 7-pole socket kit for 530 and 531 control boxes.



RIELLO S.p.A. - Via Ing. Pilade Riello, 5 - 37045 Legnago (VR) Italy
Tel. ++39.0442630111 - Fax ++39.044221980

Internet: <http://www.rielloburners.com> - E-mail: info@rielloburners.com

Since the Company is constantly engaged in the production improvement, the aesthetic and dimensional features, the technical data, the equipment and the accessories can be changed.
This document contains confidential and proprietary information of RIELLO S.p.A.
Unless authorised, this information shall not be divulged, nor duplicated in whole or in part.