



ONE STAGE GAS BURNERS

▶ RIELLO 40 FS SERIES

▶ FS3	11 ÷ 35	kW
▶ FS5	23 ÷ 58	kW
▶ FS8	46 ÷ 93	kW
▶ FS10	42 ÷ 116	kW
▶ FS20	81 ÷ 220	kW



The Riello 40 FS series of one stage gas burners, is a complete range of products developed to respond to any request for light industrial application. The Riello 40 FS series is available in five different models, with an output ranging from 11 to 220 kW, divided in four different structures.

All the models use the same components designed by Riello for the Riello 40 FS series. The high quality level guarantees safe working.

The Riello 40 FS burners are fitted with a microprocessor - based flame control panel, with diagnostic functions.

In developing these burners, special attention was paid to reducing noise, to the ease of installation and adjustment, to obtaining the smallest size possible to fit into any sort of boiler available on the market.

All the models are approved by the EN 676 European Standard and conform to European Directives for EMC, Low Voltage, Machinery and Boiler Efficiency.

All the Riello 40 FS burners are tested before leaving the factory.

TECHNICAL DATA

Model		▼ FS3	▼ FS5	▼ FS8	▼ FS10	▼ FS20
Burner operation mode		One stage				
Modulation ratio at max. output		--				
Servomotor	type	--				
	run time	s				
Heat output	kW	11 - 35	23 - 58	46 - 93	42 - 116	81 - 220
	Mcal/h	9,5 - 30	20 - 50	40 - 80	36 - 100	70 - 189
Working temperature		°C min./max. 0/40				
Net calorific value G20 gas		kWh/Nm ³ 10				
G20 gas density		kg/Nm ³ 0,71				
G20 gas delivery		1,1 - 3,5	2,3 - 5,8	4,6 - 9,3	4,2 - 11,6	8,1 - 22
Net calorific value G25 gas		kWh/Nm ³ 8,6				
G25 gas density		kg/Nm ³ 0,78				
G25 gas delivery		1,3 - 4	2,7 - 6,7	5,3 - 10,8	4,9 - 13,4	9,5 - 25,6
Net calorific value LPG gas		kWh/Nm ³ 25,8				
LPG gas density		kg/Nm ³ 2,02				
LPG gas delivery		0,4 - 1,4	0,9 - 2,2	1,8 - 3,6	1,6 - 4,4	3,1 - 8,5
Fan		type Centrifugal with forward curve blades				
Air temperature		Max. °C 40				
Electrical supply		Ph/Hz/V 1/50/230 ±10%				
Auxiliary electrical supply		Ph/Hz/V --				
Control box		type MG 557/5	MG 557/3	RMG 88.620A2		
Total electrical power		kW 0,100	0,110	0,130	0,130	0,250
Auxiliary electrical power		kW --				
Protection level		IP X0D				
Motor electrical power		kW 0,09	0,09	0,09	0,09	0,15
Rated motor current		A 0,6	0,65	0,7	0,7	1,4
Motor start up current		A 2,4	2,6	2,8	2,8	5,6
Motor protection level		IP 20				
Ignition transformer		type	Incorporated in the control box		Separated from the control box	
		V1 - V2	(-) - 8 kV		230 V - 8 kV	
		I1 - I2	(-) - 12 mA		1,8 A - 30 mA	
Operation		Intermittent (at least one stop every 24 h)				
Sound pressure		dB(A) 56	60	66	67	73
Sound power		W --				
CO emission		mg/kWh < 40				
NOx emission		mg/kWh ≤ 120				
Directive		90/396/EEC, 89/336/EEC, 73/23/EEC, 98/37/EEC, 92/42/EEC				
Conforming to		EN 676				
Certification		CE - 0063 AP6680				

Reference conditions:

Temperature: 20 °C

Pressure: 1013.5 mbar

Altitude: 100 m a.s.l.

Noise was measured in the boiler room behind the burner at a distance of 1 meter.

Since the Company is constantly engaged in the production improvement, the aesthetic and dimensional features, the technical data, the equipment and the accessories can be changed.

This document contains confidential and proprietary information of RIELLO S.p.A. Unless authorised, this information shall not be divulged, nor duplicated in whole or in part.



FIRING RATES

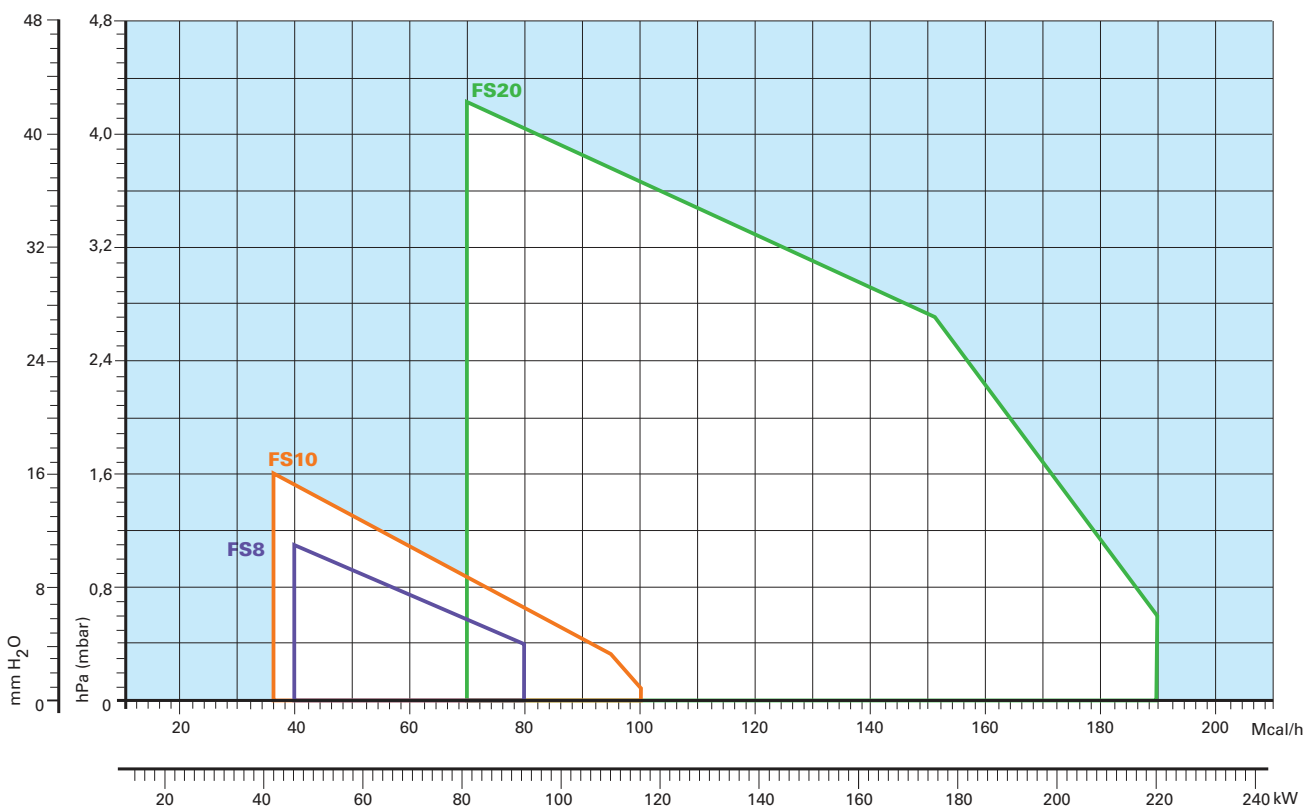
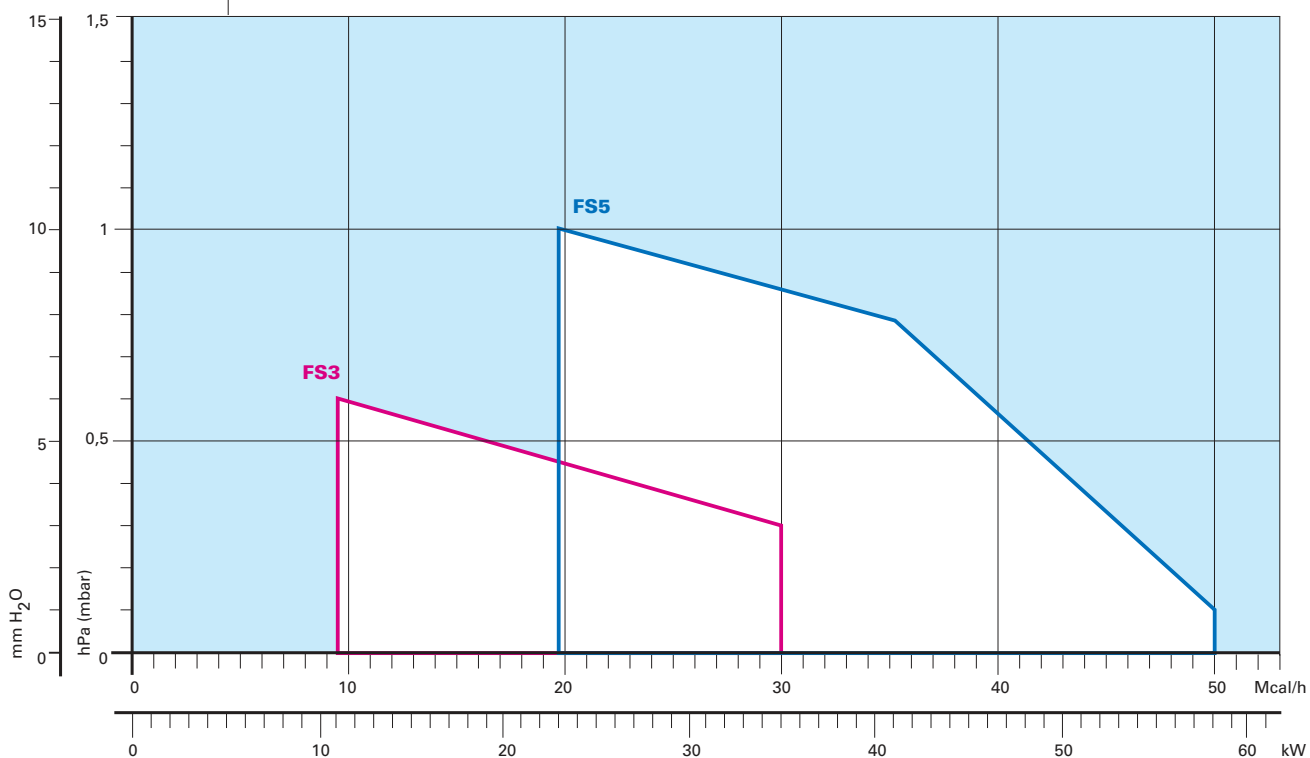

Useful working field for choosing the burner

Test conditions conforming to EN 676:

Temperature: 20 °C
 Pressure: 1013.5 mbar
 Altitude: 100 m a.s.l.





FUEL SUPPLY

GASTRAIN

The burners are set for fuel supply from either the right or left hand sides.

Depending on the gas output and the available pressure in the supply line, you should check the correct gas train to be adapted to the system requirements.

The gas train is Multibloc type, containing the main components in a single unit.

Except for the MBC 65 DLE model, a valve seal control (as accessory) can be fitted to the Multibloc gas trains.

The MBC 65 DLE Multibloc gas train can be fitted only to the left of the burner.



MBDLE 405 - 407 - 410

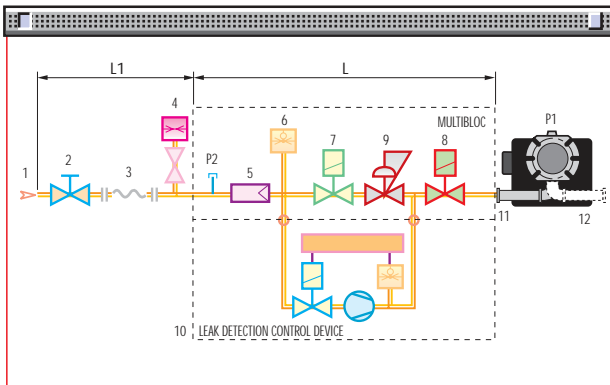

1	Gas delivery pipe
2	Manual valve
3	Vibration damping joint
4	Gas pressure gauge
5	Filter
6	Gas pressure switch
7	Safety solenoid
8	Adjustment solenoid: firing delivery adjustment (rapid opening) maximum delivery adjustment (slow opening)
9	Pressure regulator
10	Leak detection control device for valves 7 and 8 (accessory)
11	Gas train-burner adapter
12	Burner
13	Shutter with adjustment screws
14	Pressure regulator setting device
15	Regulation solenoid
P1	Combustion head pressure
P2	Upstream pressure from the filter
P3	Upstream pressure from the control valve
L	Gas train supplied separately
L1	To be performed by the installer

MBC 65 DLE

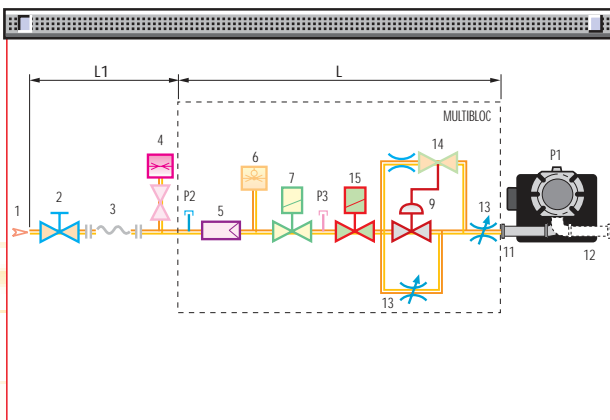

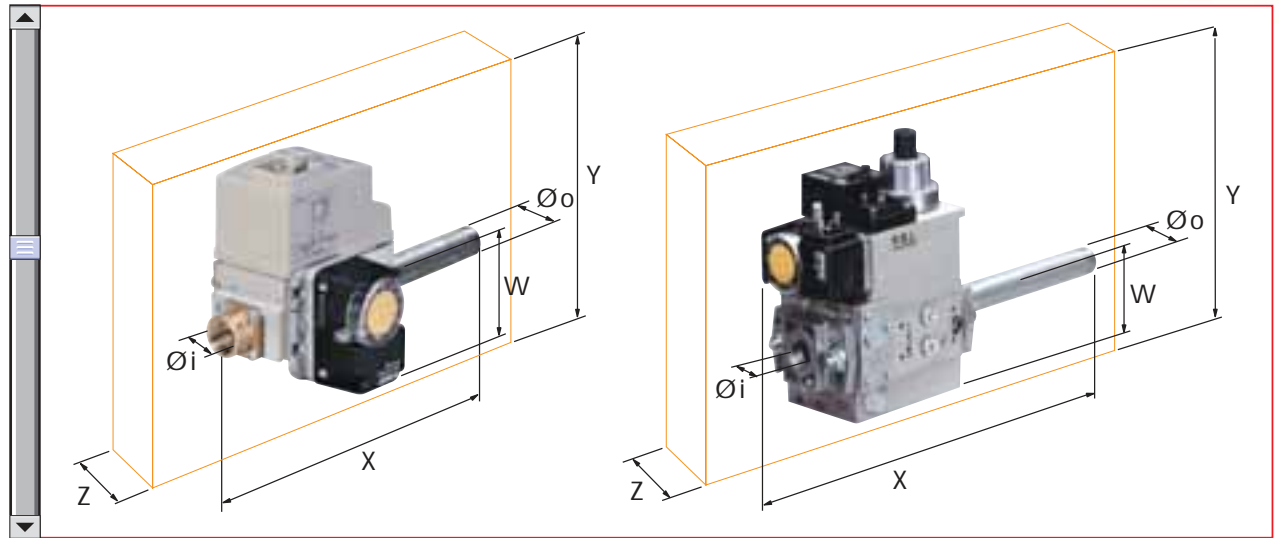

The dimensions of the gas trains vary depending on their construction features. The following table shows the dimensions of the gas trains that can be fitted to Riello 40 FS burners, intake and outlet diameters.

	Name	Code	Ø i	Ø o	X mm	Y mm	W mm	Z mm
MULTIBLOC	MBC 65 DLE	3970569	1/2"	1/2"	307	155	31	122
	MBDLE 405	3970530	1/2"	1/2"	321	186	46	120
	MBDLE 405	3970500	3/4"	3/4"	371	186	46	120
	MBDLE 407	3970531	3/4"	3/4"	371	186	46	120
	MBDLE 410	3970532	1"	3/4"	405	221	55	145

► PRESSURE DROP DIAGRAM

The diagrams indicate the minimum pressure drop of the burners with the various gas trains that can be combined with them; the values thus calculated represents the minimum required input pressure to the gas train.

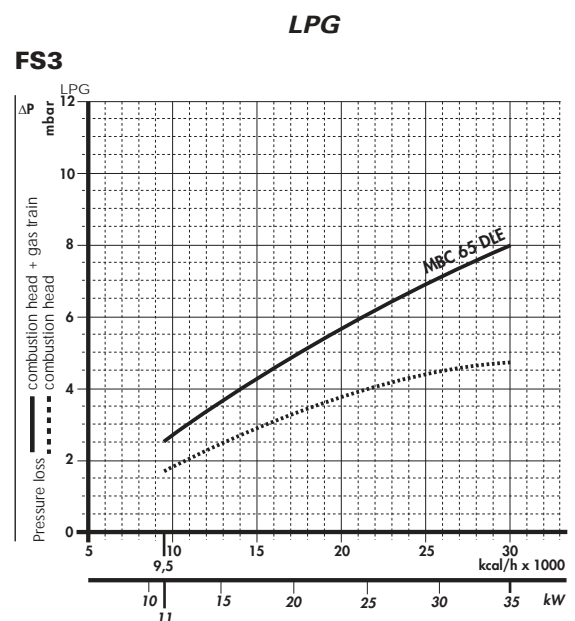
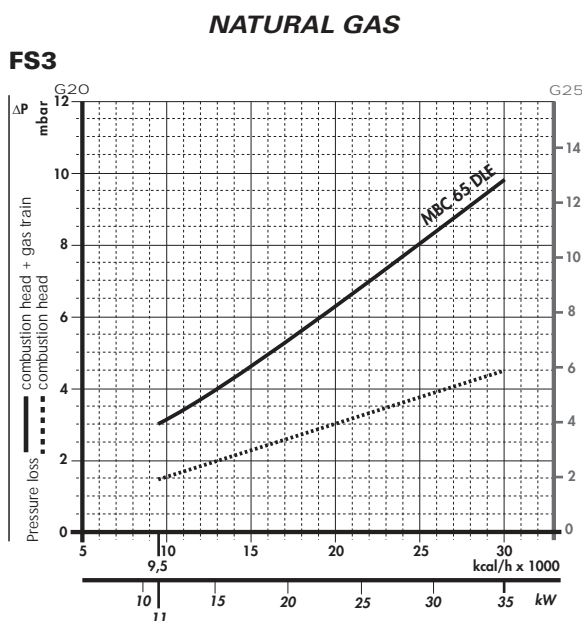

Gas train	Code	Terminal strip	Plug and socket
MBC 65 DLE	3970569		•

With installed plug (if the plug is not necessary, remove it in accordance with gas train instruction manual indication).



NATURAL GAS

FS5

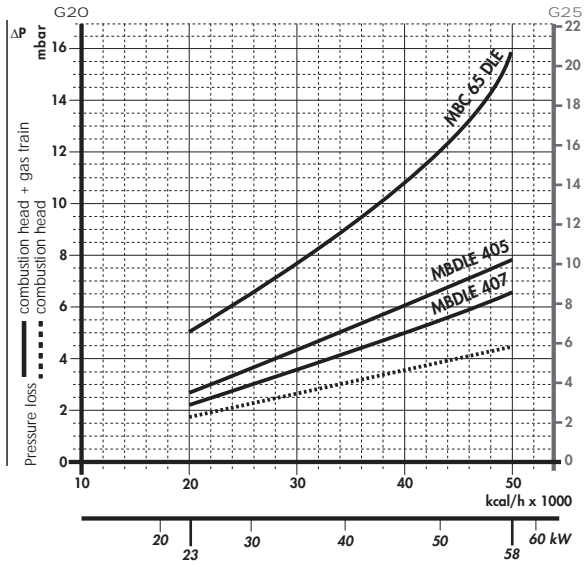

LPG

FS5

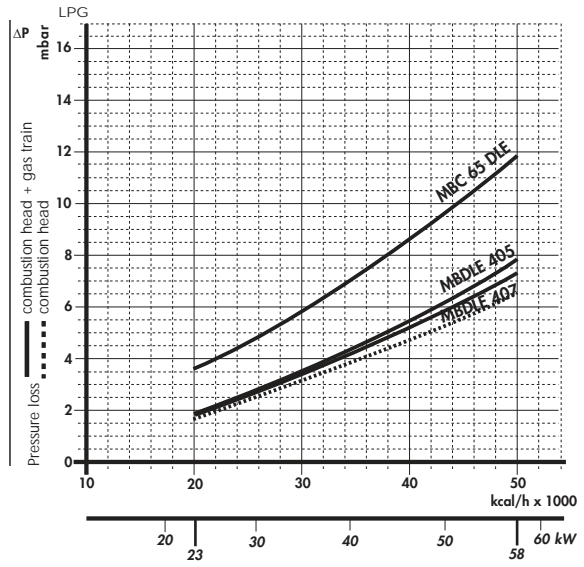

Gas train	Code	Output kW	Terminal strip	Plug and socket
MBC 65 DLE	3970569	-		•
MBDLE 405	3970530	-		•
MBDLE 407	3970531	-		•

With installed plug (if the plug is not necessary, remove it in accordance with gas train instruction manual indication).

NATURAL GAS

FS8

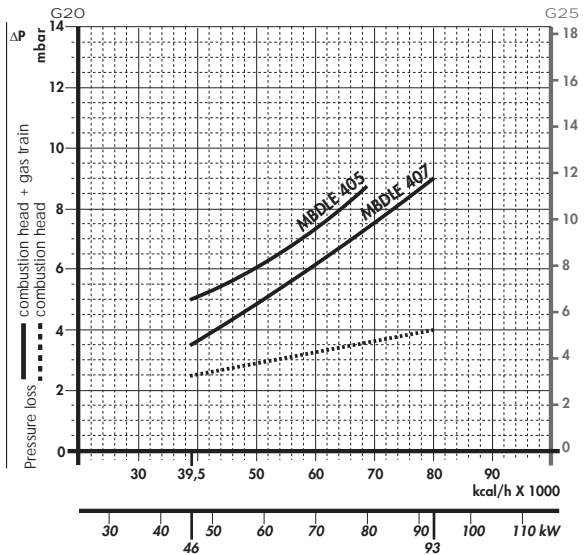

LPG

FS8

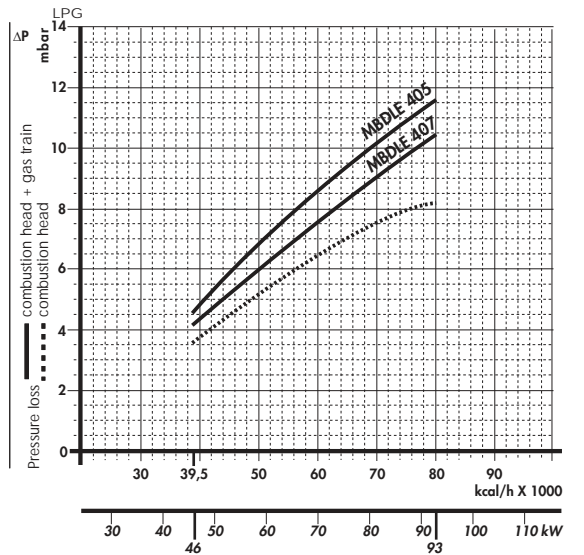

Gas train	Code	Output kW	Terminal strip	Plug and socket
MBDLE 405	3970530	≤ 80 (*)		•
MBDLE 407	3970531	-		•

(*) With natural gas.

With installed plug (if the plug is not necessary, remove it in accordance with gas train instruction manual indication).



NATURAL GAS

FS10

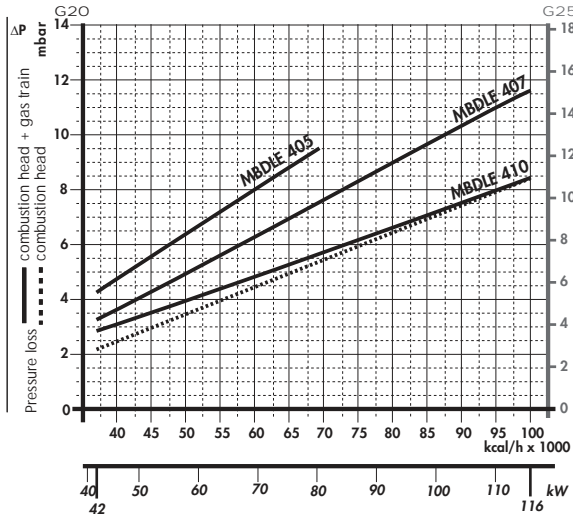

LPG

FS10

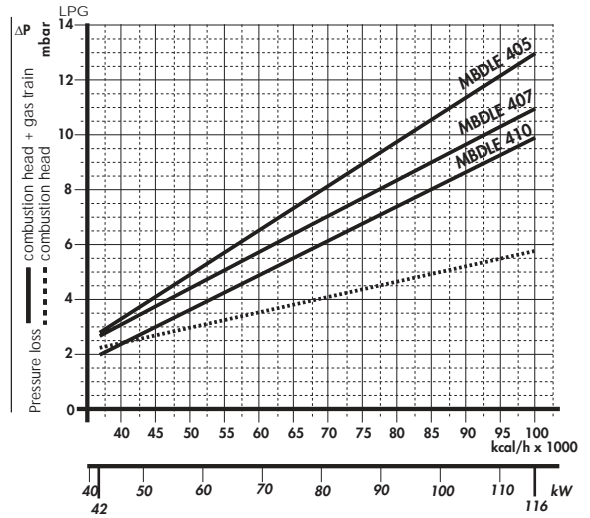

Gas train	Code	Output kW	Terminal strip	Plug and socket
MBDLE 405	3970500	≤ 80 (*)		•
MBDLE 407	3970531	-		•
MBDLE 410	3970532	-		•

(*) With natural gas.

With installed plug (if the plug is not necessary, remove it in accordance with gas train instruction manual indication).

NATURAL GAS

FS20

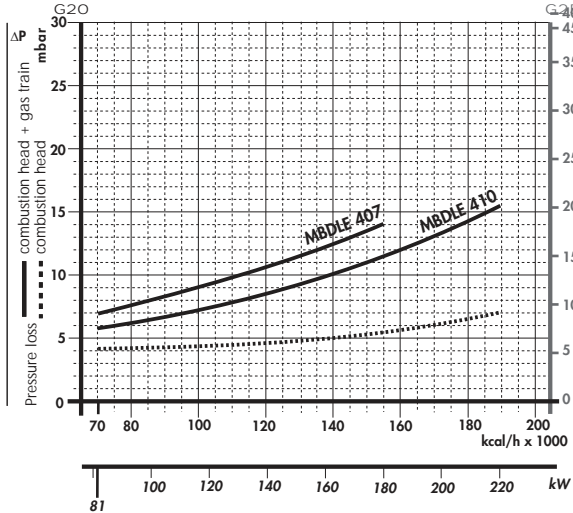

LPG

FS20

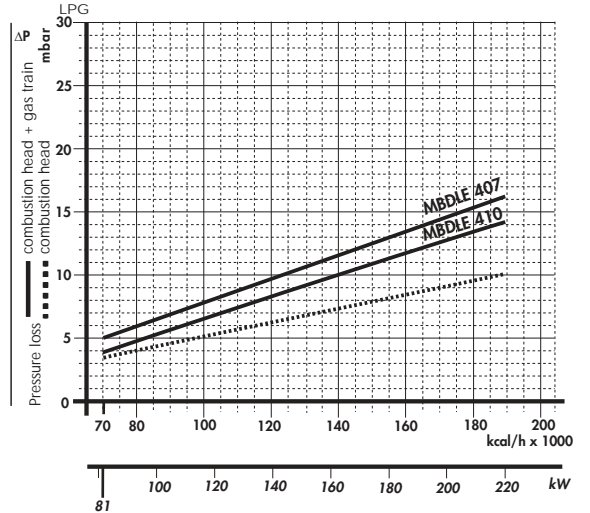

Gas train	Code	Output kW	Terminal strip	Plug and socket
MBDLE 407	3970531	≤ 180 (*)		•
MBDLE 410	3970532	-		•

(*) With natural gas.

With installed plug (if the plug is not necessary, remove it in accordance with gas train instruction manual indication).

note For pressure levels different from those indicated above, please contact Riello Burners Technical Office.
 In LPG plants, Multibloc gas trains do not operate below 0°C.
 They are only suitable for gaseous LPG (liquid hydrocarbons destroy the seal materials).





SELECTING THE FUEL SUPPLY LINES

The following diagram enables pressure drop in a pre-existing gas line to be calculated and to select the correct gas train.

The diagram can also be used to select a new gas line when fuel output and pipe length are known. The pipe diameter is selected on the basis of the desired pressure drop. The diagram uses methane gas as reference; if another gas is used, conversion coefficient and a simple formula (on the diagram) transform the gas output to a methane equivalent (refer to figure A). Please note that the gas train dimensions must take into account the back pressure of the combustion chamber during operations.

Control of the pressure drop in an existing gas line or selecting a new gas supply line.

The methane output equivalent is determined by the formula fig. A on the diagram and the conversion coefficient.

Once the equivalent output has been determined on the delivery scale (\dot{V}), shown at the top of the diagram, move vertically downwards until you cross the line that represents the pipe diameter; at this point, move horizontally to the left until you meet the line that represents the pipe length.

Once this point is established you can verify, by moving vertically downwards, the pipe pressure drop of on the bottom scale below (mbar).

By subtracting this value from the pressure measured on the gas meter, the correct pressure value will be found for the choice of gas train.

- Example:**
- gas used G25
 - gas output 9.51 mc/h
 - pressure at the gas meter 20 mbar
 - gas line length 15 m
 - conversion coefficient 0.62 (see figure A)

- equivalent methane output $\dot{V} = \left[\frac{9.51}{0.62} \right] = 15.34 \text{ mc/h}$

- once the value of 15.34 has been identified on the output scale (\dot{V}), moving vertically downwards you cross the line that represents 1" 1/4 (the chosen diameter for the piping);
- from this point, move horizontally to the left until you meet the line that represents the length of 15 m of the piping;
- move vertically downwards to determine a value of 1.4 mbar in the pressure drop bottom scale;
- subtract the determined pressure drop from the meter pressure, the correct pressure level will be found for the choice of gas train;
- correct pressure = (20-1.4) = 18.6 mbar

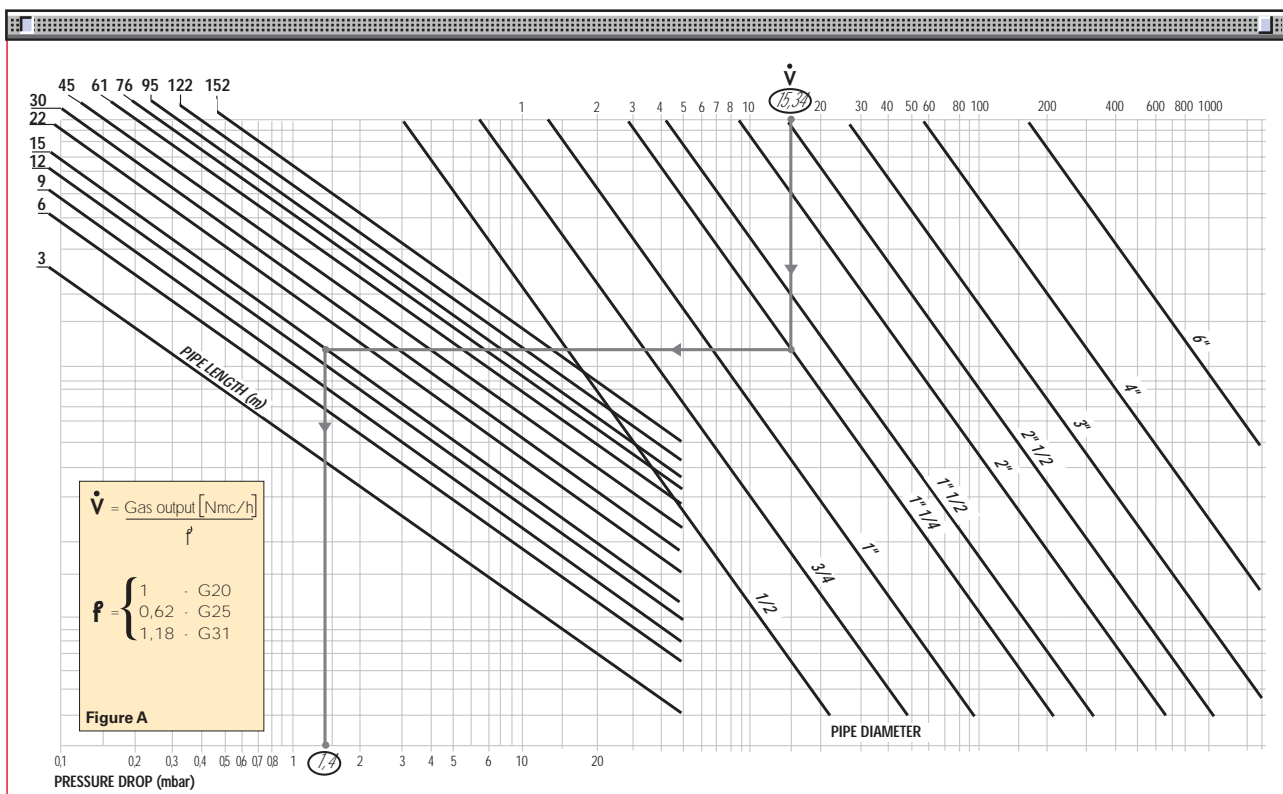

VENTILATION

The different ventilation circuits always ensure low noise levels with high performance of pressure and air delivery, in spite of their compact size.
The burners are fitted with an adjustable air pressure switch, conforming to EN 676 standards.

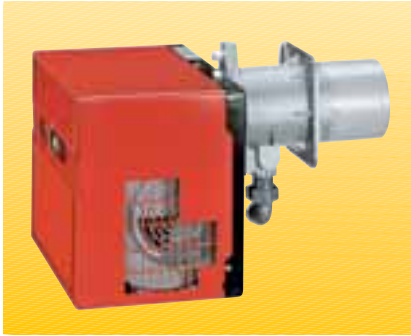

Air suction

COMBUSTION HEAD

The combustion head in Riello 40 FS burners is the result of an innovative design, which allows combustion with low polluting emissions, while being easy to adapt to all the various types of boilers and combustion chambers.



Combustion head

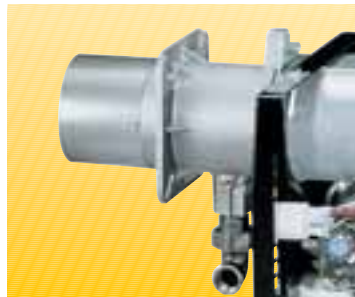

Flange

Simple adjustment allows the internal geometry of the combustion head to be adapted to the burner output.

Dimensions of the flame

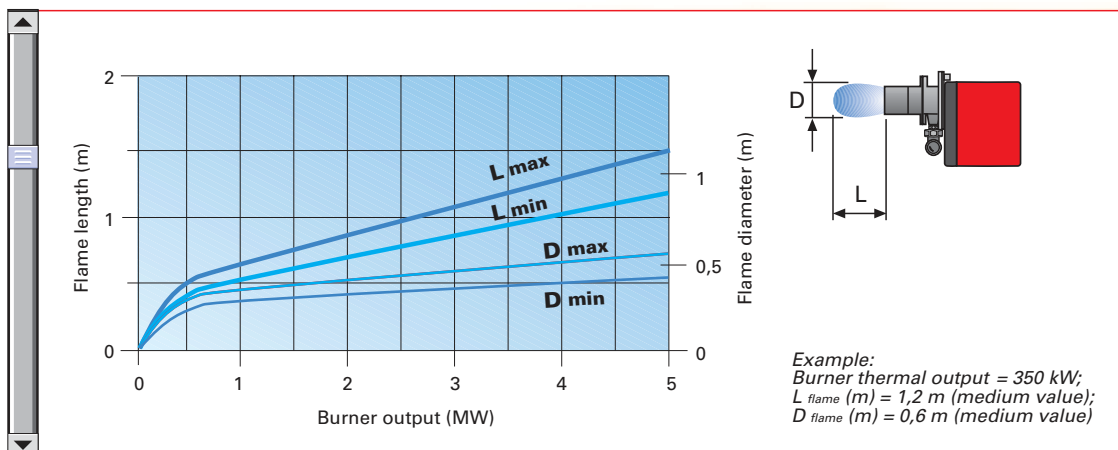



ADJUSTMENT

BURNER OPERATION MODE

All these models are one stage operation.

One stage operation

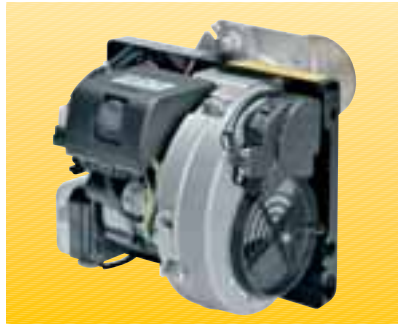
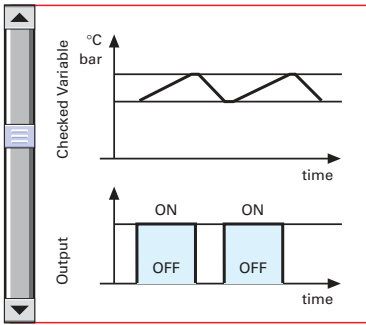

Air adjustment for FS3, FS5 and FS8



Air adjustment for FS10 and FS20

The FS3, FS5 and FS8 models are fitted with the new MG 557 microprocessor control panel.

For helping the commissioning and maintenance work, there are two main elements:



The lock-out reset button is the central **operating element** for resetting the burner control and for activating / deactivating the diagnostic functions.



The multi-color LED is the central **indication element** for visual diagnosis and interface diagnosis.

Both elements are located under the transparent cover of lock-out reset button, as showed below.

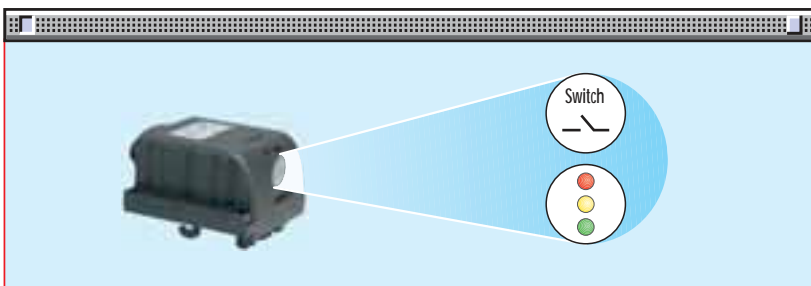

There are two diagnostic choices, for indication of operation and diagnosis of fault cause:

- visual diagnosis:

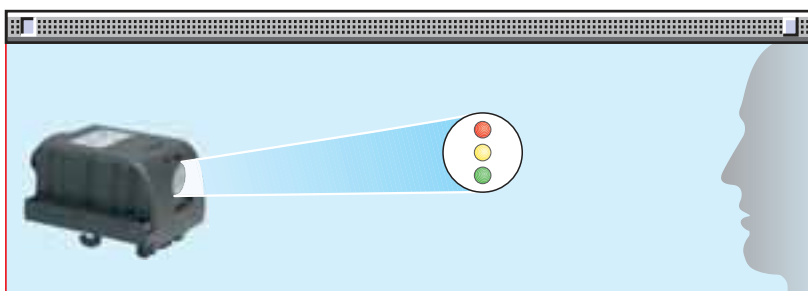

- interface diagnosis:

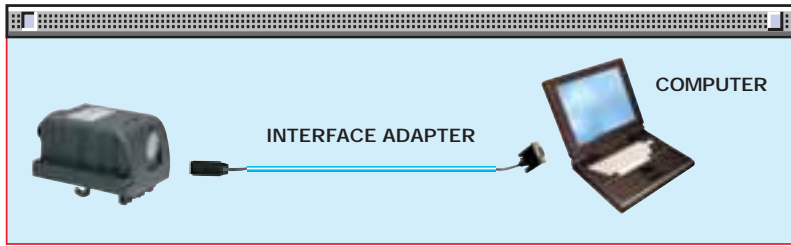

by the interface adapter and a PC with dedicated software.

Indication of operation:

Color code table	
Operation status	Color code
Stand-by	○ Led off
Pre-purging	● Green
Ignition phase	● Green
Flame OK	● Green
Post purge	● Green
Undervoltage, built-in fuse	○ Led off
Fault, alarm	● Red
Flame simulation	○ Led off

In normal operation, the various status are indicated in the form of colour codes according to the table below.

Diagnosis of fault causes:

After lock-out has occurred, the red signal lamp is steady on. In this status, the visual fault diagnosis according to the error code table can be activated by pressing the lock-out reset button for > 3 seconds. The interface diagnosis (with adapter) can be activated by pressing again the lock-out button for > 3 seconds.

Example of flashes sequence:

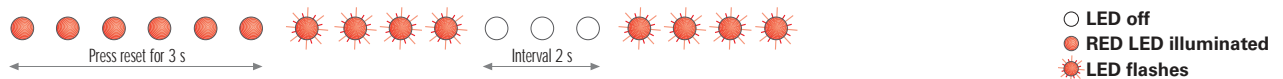

Error code table	
Signal	Probable cause
2 flashes ●●	The flame does not stabilise at the end of the safety time: - faulty ionisation probe - faulty or soiled gas valves - neutral/phase exchange - faulty ignition transformer - poor burner regulation (insufficient gas)
3 flashes ●●●	Min. air pressure switch does not close or is already closed before the limit thermostat closed: - air pressure switch faulty - air pressure switch incorrectly regulated
4 flashes ●●●●	Presence of flame: - in stand-by position after heat demand - during pre-purging
6 flashes ●●●●●●	Loss air pressure: - during pre-purging - during safety time or operations
7 flashes ●●●●●●●	Loss of flame 4 times during operations after 3 attempts of re-cycle: - poor burner regulation (insufficient gas) - faulty or soiled gas valves - short circuit between ionisation probe and earth - faulty ionisation probe



The FS10 and FS20 models are also fitted with the RMG 88.620 A2 microprocessor control panel for the supervision during intermittent operation.

For helping the commissioning and maintenance work, there are two main elements:



The lock-out reset button is the central **operating element** for resetting the burner control and for activating / deactivating the diagnostic functions.



The multi-color LED is the central **indication element** for visual diagnosis and interface diagnosis.

Both elements are located under the transparent cover of lock-out reset button, as showed below.

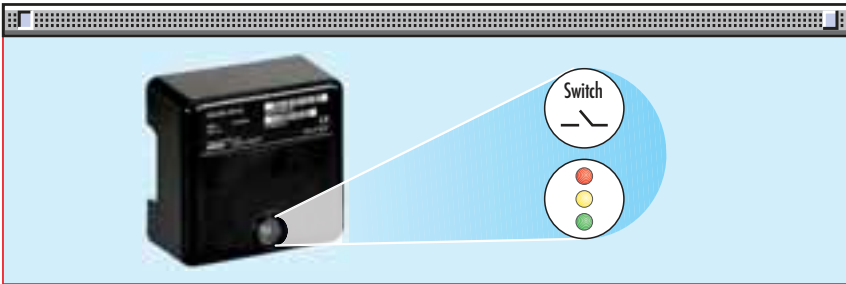

There are two diagnostic choices, for indication of operation and diagnosis of fault cause:

- visual diagnosis:

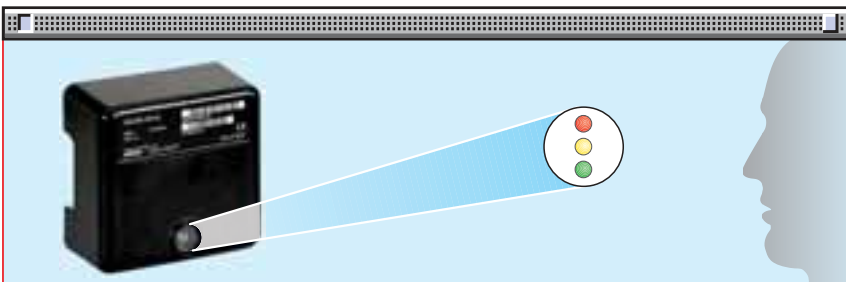

- interface diagnosis:



by the interface adapter and a PC with dedicated software or by a predisposed flue gas analyzer (see paragraph accessories).

Indication of operation:

Color code table	
Operation status	Color code table
Stand-by	○ ○ ○ ○ ○ ○ ○ ○
Pre-purging	☀ ☀ ☀ ☀ ☀ ☀ ☀ ☀
Ignition phase	☀ ○ ☀ ○ ☀ ○ ☀ ○
Flame OK	☘ ☘ ☘ ☘ ☘ ☘ ☘ ☘
Poor flame	☘ ○ ☘ ○ ☘ ○ ☘ ○
Undervoltage, built-in fuse	☀ ☘ ☀ ☘ ☀ ☘ ☀ ☘
Fault, alarm	☘ ☘ ☘ ☘ ☘ ☘ ☘ ☘
Extraneous light	☘ ☘ ☘ ☘ ☘ ☘ ☘ ☘

In normal operation, the various status are indicated in the form of colour codes according to the table below. The interface diagnosis (with adapter) can be activated by pressing the lock-out button for > 3 seconds.

○ LED off



Diagnosis of fault causes:

After lock-out has occurred, the red signal lamp is steady on. In this status, the visual fault diagnosis according to the error code table can be activated by pressing the lock-out reset button for > 3 seconds. The interface diagnosis (with adapter) can be activated by pressing again the lock-out button for > 3 seconds.

The flashes of red LED are a signal with this sequence:
(e.g. signal with n° 3 flashes – faulty air pressure monitor)



Error code table	
Possible cause of fault	Flash code
No establishment of flame at the end of safety time: - faulty or soiled fuel valves - faulty or soiled flame detector - poor adjustment of burner, no fuel - faulty ignition equipment	2 flashes
Faulty air pressure monitor	3 flashes
Simulation of flame on burner start up	4 flashes
Loss of flame during operation: - faulty or soiled fuel valves - faulty or soiled flame detector - poor adjustment of burner	7 flashes
Wiring error or internal fault	10 flashes

START UP CYCLE

FS3 - FS5 - FS8

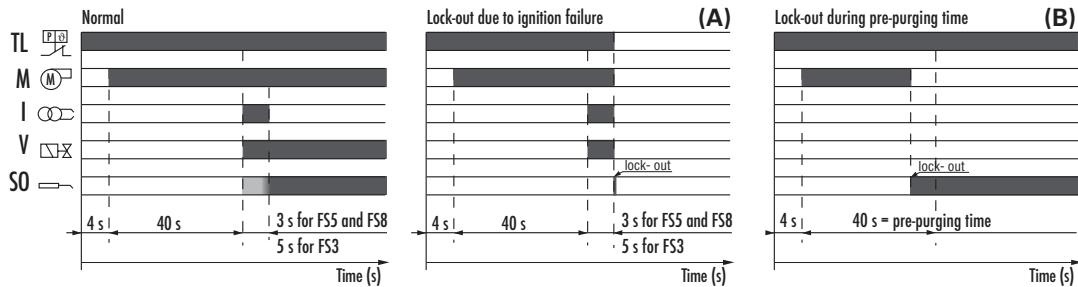

Correct operation for FS3, FS5 and FS8 models:

- 0s The burner begins the ignition cycle
- 0s-4s The control box waits still after the heat request
- 4s-44s Pre-purging time with start of the fan motor
- 44s-47s FS5 and FS8 safety time as total ignition time
- 44s-49s FS3 safety time as total ignition time.

Lock-out due to ignition failure

If the flame does not light within the safety limit time (3s for FS 5 and FS8; 5s for FS3) the burner locks-out.

FS10 - FS20

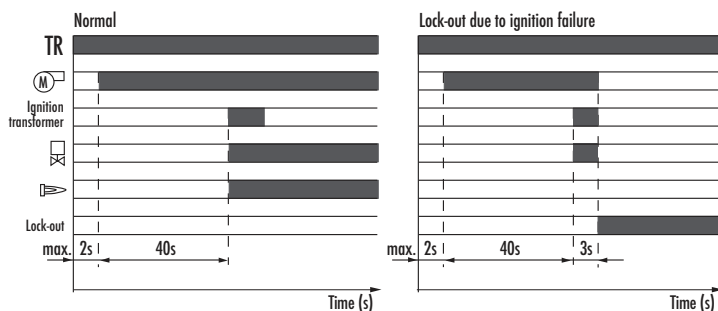

Correct operation for FS10 and FS20 models:

- 0s The burner begins the ignition cycle
- 0s-2s Safety time
- 2s-40s Pre-purge with the air damper open
- 40s Ignition.

Lock-out due to ignition failure

If the flame does not light within the safety limit (3s) the burner locks-out. When the flame-failure occurs during working, shut down takes place within one second.

(A) - (B) Lock-out is shown by a led on the appliance.



WIRING DIAGRAMS

Electrical connections must be made by qualified and skilled personnel in conformity with the local regulations in force.



FS3 is fitted with terminal strip; FS5, FS10 and FS20 are fitted with 7 and 6 pole sockets, FS8 is available in both the configurations



Control box fitted with an ignition transformer in FS3, FS5 and FS8 models



In FS10 and FS20 models the control box is separated from the ignition transformer

ONE STAGE OPERATION

FS3 - FS5 - FS8

Burner electrical wiring

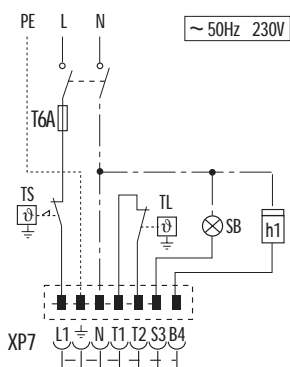

- h1** - Hour counter (230V - 0,1A max.)
- PG** - Minimum gas pressure switch
- SB** - Lock-out led (230V - 0,5A max.)
- TL** - Limit thermostat
- TS** - Safety thermostat
- T6A** - Fuse
- V1** - Adjustment valve
- VS** - Safety valve
- XP6** - 6 pole socket
- XP7** - 7 pole socket

Gas train electrical wiring

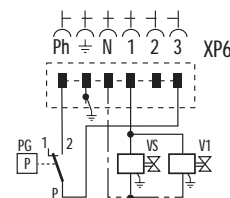

FS10 - FS20

Burner electrical wiring

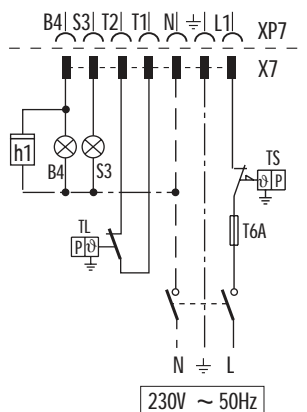

- XP6** - 6 pole socket
- XP7** - 7 pole socket
- X6** - 6 pin plug
- X7** - 7 pin plug
- B4** - Working signal
- h1** - Hour counter
- PG** - Minimum gas pressure switch
- S3** - Remote lock-out signal (230V - 0,5A max.)
- TL** - Limit thermostat
- TS** - Safety thermostat
- V10** - Safety valve
- V11** - Adjustment valve
- T6A** - Fuse

Gas train electrical wiring

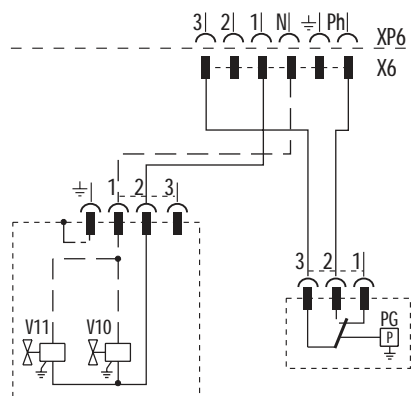

Electrical wiring with gas leak control device (DUNGS VPS 504)



Gas train electrical wiring

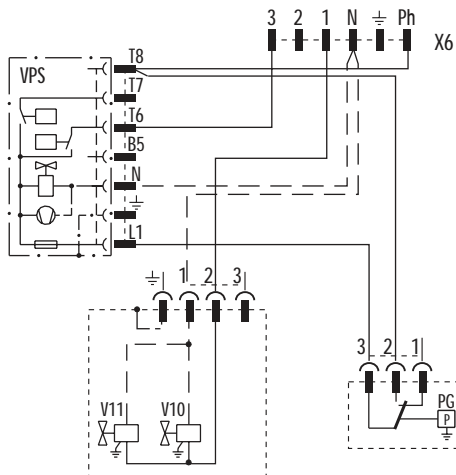

Burner electrical wiring

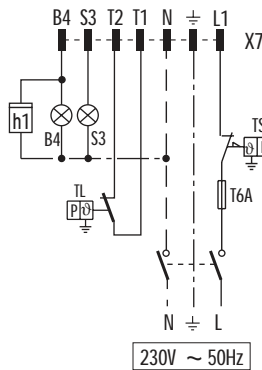

- XP6** - 6 pole socket
- XP7** - 7 pole socket
- X6** - 6 pin plug
- X7** - 7 pin plug
- B4** - Working signal
- h1** - Hour counter
- PG** - Minimum gas pressure switch
- S3** - Remote lock-out signal (230V - 0,5A max.)
- TL** - Limit thermostat
- TS** - Safety thermostat
- V10** - Safety valve
- V11** - Adjustment valve
- T6A** - Fuse

The following table shows the supply lead sections and types of fuse to be used.

Model	▼ FS3	▼ FS5	▼ FS8	▼ FS10	▼ FS20
	230V	230V	230V	230V	230V
F A	T6	T6	T6	T6	T6
L mm ²	1	1	1	1	1

F = Fuse L = Lead section

EMISSIONS

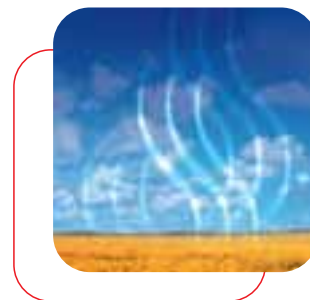
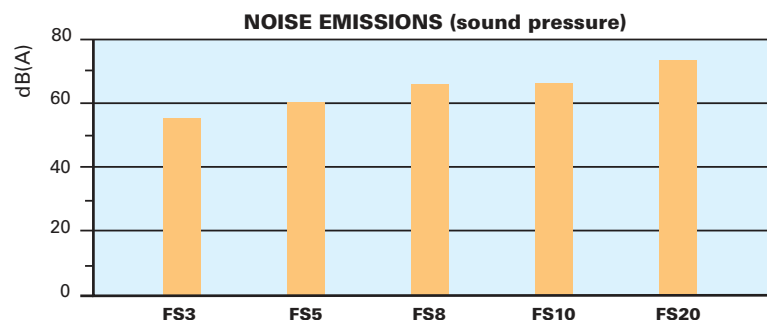
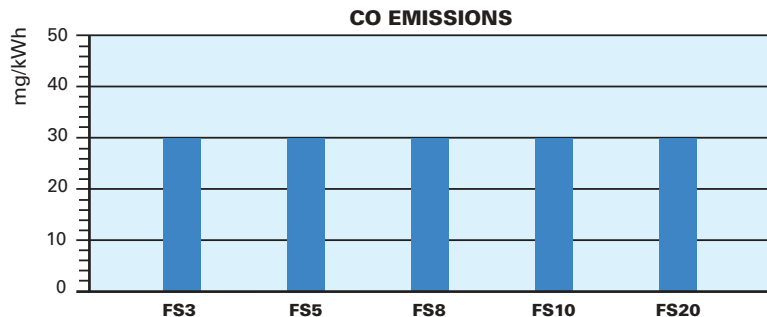
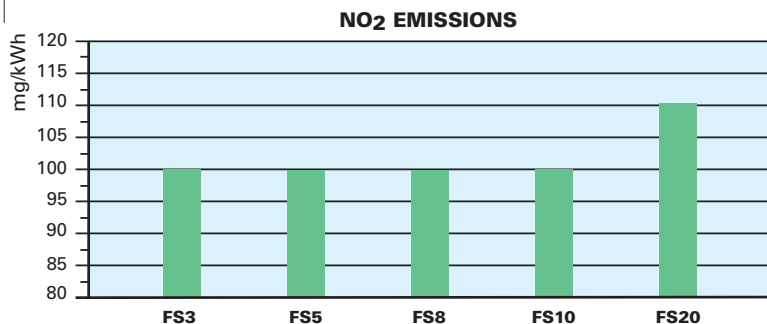

The emission data have been measured in the various models at maximum output, in conformity with EN 676 standard.

Special attention has been paid to noise reduction in the FS3 model. The model is fitted with sound-proofing material inside the cover.





OVERALL DIMENSIONS (mm)

These models are distinguished by their reduced size, in relation to the outputs achieved, which means they can be fitted to any boiler actually on the market.

BURNER

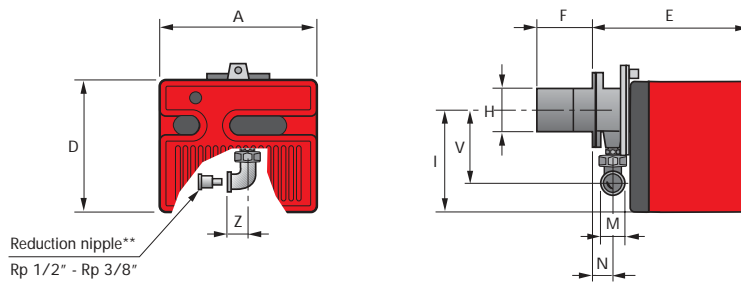

Model	A	D	E	F	H	I	M	N	V	Z
▶ FS3	252	215	230	100	91	165	Rp 3/8"*	37	132	25
▶ FS5	272	233	295	100	91	180	Rp 1/2"	48	138	28
▶ FS8	305	262	347	110	105	204	Rp 3/4"	61	142	33
▶ FS10	305	262	346	110	105	204	Rp 3/4"	61	142	33
▶ FS20	350	298	389	120	125	230	Rp 3/4"	67	152	33

* With reduction nipple

** Standard equipment on R40 FS3

BURNER-BOILER MOUNTING FLANGE

FS3 - FS5 - FS10

FS20

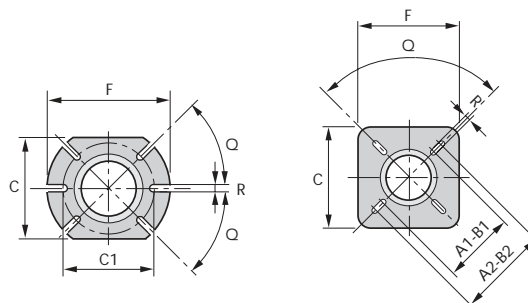

Model	A1	A2	B1	B2	C	C1	F	Q	R
▶ FS3	-	-	-	-	140	130	170	45	10
▶ FS5	-	-	-	-	140	130	170	45	10
▶ FS8	-	-	-	-	160	130	185	45	11
▶ FS10	-	-	-	-	160	130	185	45	11
▶ FS20	155	200	155	200	170	-	170	90	11

PACKAGING

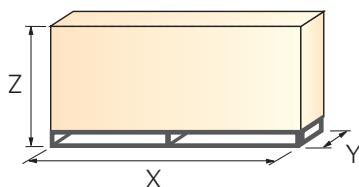

Model	X	Y	Z	kg
▶ FS3	365	325	300	5
▶ FS5	435	345	315	11
▶ FS8	473	413	320	13,6
▶ FS10	473	413	320	17
▶ FS20	525	453	365	17

INSTALLATION DESCRIPTION

Installation, start up and maintenance must be carried out by qualified and skilled personnel.

The burner is set in factory on standard calibration (minimum output), if necessary adjustments can be made on the basis of the maximum output of the boiler.

All operations must be performed as described in the technical handbook supplied with the burner.



BURNER SETTING

- ▶ The air damper position can be easily adjusted removing the burner cover.



- ▶ Head setting is easy and aided by a graduated scale, a test point allows reading the air pressure in the combustion head.



- ▶ Riello 40 FS burners are fitted with an air pressure switch which, in accordance with EN 676 standards, can be adjusted by the installer using a graduated selector, on the basis of the effective working conditions.



MAINTENANCE

- ▶ Maintenance is easily solved because the combustion head can be disassembled without having to remove the burner from the boiler.





BURNER ACCESSORIES

Remote reset control kit for MG 557/3/5 control box

The MG 557 control box can be remotely released using an electric command kit. This kit must be installed in conformity with the local authority.

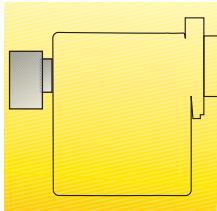

Remote reset control kit for MG 557/3/5 control box	
Burner	Kit code
FS3 - FS5 - FS8	3002750

Extended head kit

“Standard head” burners can be transformed into “extended head” versions by using the special kit. Below the KITS available for the various burners are listed, showing the original and the extended lengths.

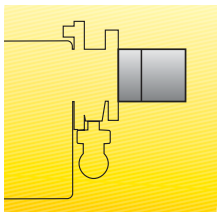

Extended head kit			
Burner	Standard head length (mm)	Extended head length (mm)	Kit code
FS3 - FS5	100	125	3000820
FS8 - FS10	110	170	3000864
FS8	110	278	3000920
FS20	120	280	3000873

End cone with turbulator disk

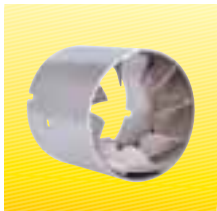

End cone with turbulator disk		
Burner	Projection (mm)	Kit code
FS5	+15	3000916
FS8	+18	3000917
FS10	+18	3000918
FS20	+23	3000919

LPG kit

For burning LPG gas, a special kit is available to be fitted to the combustion head on the burner, as shown in the following table:



LPG kit		
Burner	Kit code for standard head	Kit code for extended head
FS3	3000881	3000881
FS5	3000882	3000882
FS8	3000927	3000927
FS10	3000884	3000884
FS20	3000886	3000886

7-pin plug kit

If necessary a 7-pin plug kit is available (in packaging of n. 5 pieces).

7-pin plug kit	
Burner	Kit code
FS3 - FS5 - FS8 - FS10 - FS20	3000945

Town gas kit

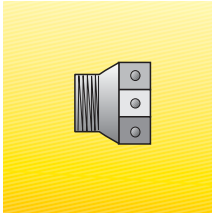

Town gas kit	
Burner	Kit code
FS3	3000888
FS5	3000889
FS8	3000890
FS10	3000891
FS20	3000893

PC interface kit

To connect the flame control panel to a personal computer for the transmission of operation, fault signals and detailed service information, an interface adapter with PC software are available.



Interface kit	
Burner	Kit code
FS3 - FS5 - FS8	3002731
FS10 - FS20	3002719

Ground fault interrupter kit

A "Ground fault interrupter kit" is available as a safety device in case of electrical system fault. It is supplied with burners pin plug.



Ground fault interrupter kit	
Burner	Kit code
FS5 - FS8 - FS10 - FS20	3001180

Continuous ventilation kit for RMG control box

If the burner requires continuous ventilation in the stages without flame, a special kit is available as given in the following table.

Continuous ventilation kit for RMG control box	
Burner	Kit code
FS10 - FS20	3010094

GAS TRAIN ACCESSORIES

Seal control kit

To test the valve seals on the gas train, (except for the model with Multibloc MBC 65 DLE) a special "seal control kit" is available.



Seal control kit	
Burner	Kit code
FS5 - FS8 - FS10 - FS20	3010123



▶ **BALANCED FLUE VERSION**

The R40 series balanced flue gas burner has been specifically designed to meet the increasing trend towards the use of balanced flue, otherwise known as room sealed appliances, which avoid the necessity of having a chimney to discharge the products of combustion.

Balanced flue products are completely sealed from the environment in which they are installed, drawing air for combustion directly from the outside, thereby ensuring no unwelcome smells from the combustion.

As a result of the burner components being completely enclosed this provides an additional benefit of low sound levels.

This version is available for FS3 and FS5 only.



Riello 40 FS Balanced Flue version

Overall dimensions (mm)

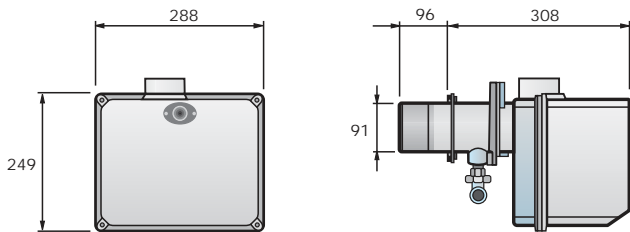

SPECIFICATION



A special index guides your choice of boiler from the various models available in the FS series. Below is a clear and detailed specification description of the product.

▶ **DESIGNATION OF SERIES**

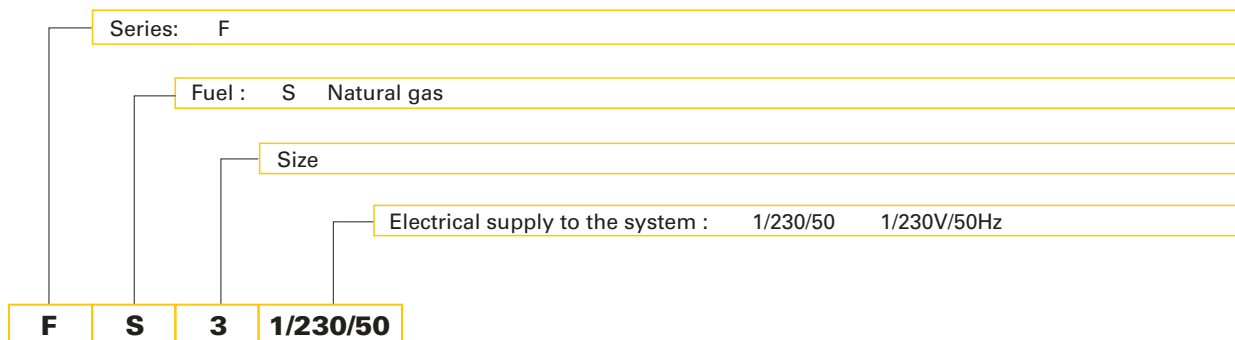

▶ **AVAILABLE BURNER MODELS**

FS3	1/230/50
FS5	1/230/50
FS8	1/230/50
FS10	1/230/50
FS20	1/230/50



▶ **PRODUCT SPECIFICATION**

Burner

Monoblock, gas burners, completely automatic, with one stage settings fitted with:

- Fan with forward curve blades
- Cover lined with sound-deadening material
- Metallic and fixed air damper with adjustment
- Single phase electric motor 230 V, 50 Hz
- Combustion head fitted with:
 - stainless steel head cone, resistant to high temperatures
 - ignition electrodes
 - ionisation probe
 - gas distributor
 - flame stability disk
 - flame inspection window
- Adjustable air pressure switch, with graduated selector, to guarantee burner lock out in the case of insufficient combustible air
- Microprocessor-based flame control panel MG 557 (with diagnostic, remote reset, continuous purge integrated, recycle, post-purge)
- IP X0D electric protection level.

Gas train

Fuel supply line in the Multibloc configuration, fitted with:

- Filter
- Pressure stabiliser
- Minimum gas pressure switch
- Safety valve
- Single stage working valve with ignition gas output regulator.

Approval:

- EN 676 standard.

Conforming to:

- 90/396/EEC (gas)
- 73/23/EEC (low voltage)
- 89/336/EEC (electromagnetic compatibility)
- 92/42/EEC (efficiency)
- 98/37/EEC (machines).

Standard equipment:

- Flange insulation screen
- Screws and nuts for fixing the flange to the boiler
- 7-pole socket
- Hinge
- Reduction nipple Rp 1/2" - Rp 3/8" (for R40 FS3 only)
- Grommet
- Instruction handbook for installation, use and maintenance
- Spare parts catalogue.

Available accessories to be ordered separately:

- Remote reset kit for MG 557/3/5 control box
- Extended head kit
- End cone with turbulator disk
- LPG kit
- 7-pin plug kit
- Town gas kit
- PC interface kit
- Ground fault interrupter kit
- Continuous ventilation kit for RMG control box
- Balanced flue version
- Seal control kit.







RIELLO S.p.A. - Via Ing. Pilade Riello, 5 - 37045 Legnago (VR) Italy
Tel. ++39.0442630111 - Fax ++39.044221980

Internet: <http://www.rielloburners.com> - E-mail: info@rielloburners.com

Since the Company is constantly engaged in the production improvement, the aesthetic and dimensional features, the technical data, the equipment and the accessories can be changed.
This document contains confidential and proprietary information of RIELLO S.p.A.
Unless authorised, this information shall not be divulged, nor duplicated in whole or in part.

