

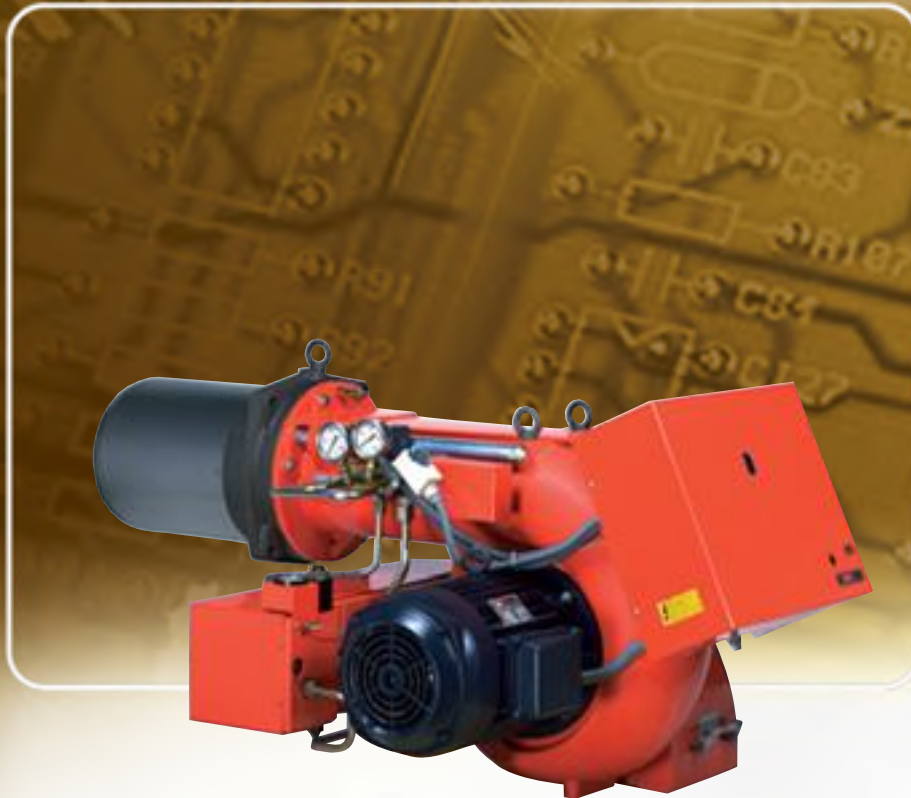

MODULATING HEAVY OIL BURNERS

▶ PRESS P/N - P/N ECO SERIES	
▶ P 140 P/N	400/800 ÷ 1600 kW
▶ P 200 P/N	570/1140 ÷ 2280 kW
▶ P 300 P/N	683/1710 ÷ 3420 kW
▶ P 450 P/N	1140/2615 ÷ 5130 kW
▶ P 140 P/N ECO	400/800 ÷ 1600 kW
▶ P 200 P/N ECO	570/1140 ÷ 2280 kW
▶ P 300 P/N ECO	683/1710 ÷ 3420 kW
▶ P 450 P/N ECO	1140/2615 ÷ 5130 kW



The PRESS P/N series of burners covers a firing range from 400 to 5130 kW. They have been designed in three versions for use in commercial and industrial installation, to burn different oil viscosity from 7 up to 60°E @ 50°C.

Operation can be "two stage progressive" or, alternatively, "modulating" with the installation of a PID logic regulator and respective probes, which guarantees a turn down ratio of 3:1. The versatility of this range makes the burner well suited for use on steam boilers where the load factor is subject to wide variations, on thermal oil boilers and on boilers for particular heating plants, as hospitals or similar.

Simplified maintenance is achieved by the Riello designed slide bar system, which allows easy access to all of the essential components of the combustion head.

TECHNICAL DATA

Model		▼ P 140 P/N	▼ P 200 P/N	▼ P 300 P/N	▼ P 450 P/N
Setting type		Modulating (with regulator and probes accessories) or Two stage progressive			
Modulation ratio to max. output		4 : 1			
Servo-motor	type	SQM 10			
	run time	s			
Heat output	kW	400/800÷1600	570/1140÷2280	683/1710÷3420	1140/2615÷5130
	Mcal/h	344/788÷1376	490/980÷1753	587/1471÷2941	980/2249÷4412
Heavy oil delivery	kg/h	35/70÷140	50/100÷200	60/150÷300	100/225÷450
Working temperature	°C min./max.	0/40			
NCV Heavy Oil	kcal/kg	9800			
	kWh/kg	11.4			
	MJ/kg	41			
Low viscosity version	mm ² /s (cSt)	50 @ 50°C			
Pump	type	SUNTEC E7	SUNTECTA2	SUNTECTA3	SUNTECTA4
	delivery	kg/h at 25 bar	340	470	750
Medium viscosity version	mm ² /s (cSt)	200 @ 50°C (with heavy oil kit already installed in factory)			
Pump	type	SUNTEC E7	SUNTECTA2	SUNTECTA3	SUNTECTA4
	delivery	kg/h at 25 bar	340	470	750
High viscosity version	mm ² /s (cSt)	450 @ 50°C (separate 1400 rpm pump + heavy oil kit + pipes heating cable already installed in factory)			
Pump	type	SUNTECTA3	SUNTECTA4	SUNTECTA5	HP NVBHR M
	delivery	kg/h at 25 bar	380	480	690
Atomised pressure	bar	25			
Fuel temperature	Max. °C	140			
Fan	type	Centrifugal - curved forward blades			
Air temperature	Max. °C	60			
Electrical supply	Ph/Hz/V	3N/50/400-230 (+10% -15%) 人 or 3/50/230 (+10% -15%) △			
Electrical power consumption	Max. kW	18,5	19,5	32	37
Electrical motor	kW	3	4	7,5	15
Motor start current	A	86/51	83/48	195/113	301/174
Motor running current	A	13,5/8	16,4/9,5	30/17,5	50,2/29
Motor electrical protection	IP	55			
Pump motor electrical power (*)	kW	0,55	0,75	1,1	2,2
Rated pump motor current (*)	A	1,8/3,1	2,1/3,7	2,7/4,7	5,5/9,5
Auxiliary electrical supply	Ph/Hz/V	1/50/230 (±10%)			
Heaters electrical power	kW	14	14	19,6	19,6
Auxiliary electrical power	kW	1,5	1,5	2,9	2,4
Electrical protection	IP	40			
Control box	type	LANDIS LAL 1.25			
Ignition transformer	V1 - V2	230 V - 2x6 kV			
	I1 - I2	2,3 A - 35 mA			
Operation		Intermittent (at least one stop every 24 h)			
Sound pressure	dB (A)	86,2	85,4	89,5	90
Sound power	W	--			
CO emission	mg/kWh	< 130	< 145		< 170
Grade of smoke indicator	N° Bacharach	< 6		< 5	< 4
C _x H _y emission	mg/Nm ³	--			
NO _x emission level	mg/kWh	< 780	< 550		
Directive		89/336 - 73/23 EEC			
Conforming to		EN 267			
Certification		--	--	--	--

(*) For High viscosity versions only.

Reference conditions:

Ambient temperature: 20°C

Barometric pressure: 1000 mbar

Altitude: 100 meters a.s.l.

Sound pressure level measured in manufacturers combustion laboratory, with burner operating on test boiler and at maximum rated output.

Since the Company is constantly engaged in the production improvement, the aesthetic and dimensional features, the technical data, the equipment and the accessories can be changed.

This document contains confidential and proprietary information of RIELLO S.p.A. Unless authorised, this information shall not be divulged, nor duplicated in whole or in part.

FIRING RATES

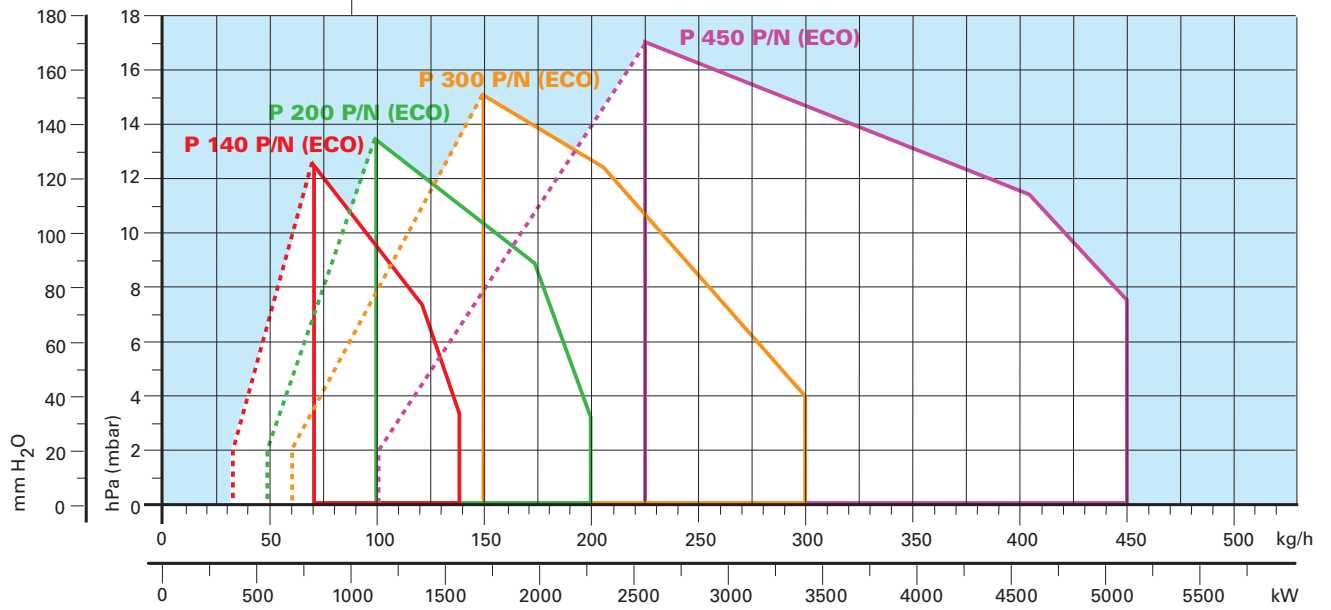

 Useful working field for choosing the burner

 Modulation range

Test conditions conforming to EN 267:

Temperature: 20°C
 Pressure: 1013.5 mbar
 Altitude: 100 m a.s.l.



FUEL SUPPLY

HYDRAULIC CIRCUITS

Various hydraulic circuits are available, depending on fuel output asset according to local norms of steam generators.

The burners are fitted with two valves and an oil preheater with thermostats along the oil line from the pump to the nozzle, where the opening is regulated from a needle valve.

A pressure regulator on the return circuit from the nozzle allows to vary the quantity of fuel burnt.

For heavy oil preheating, a special kit with three electrical heaters at the pump, at the regulator and at the nozzle can be used.

The models are fitted with a maximum pressure switch on the oil return circuit.

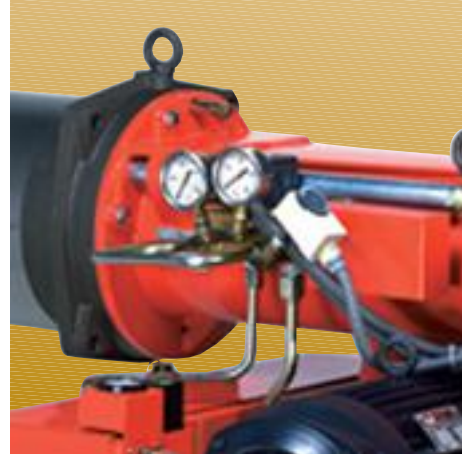

Example of the hydraulic circuit on PRESS 200 P/N

prEN 267 > 100 Kg/h

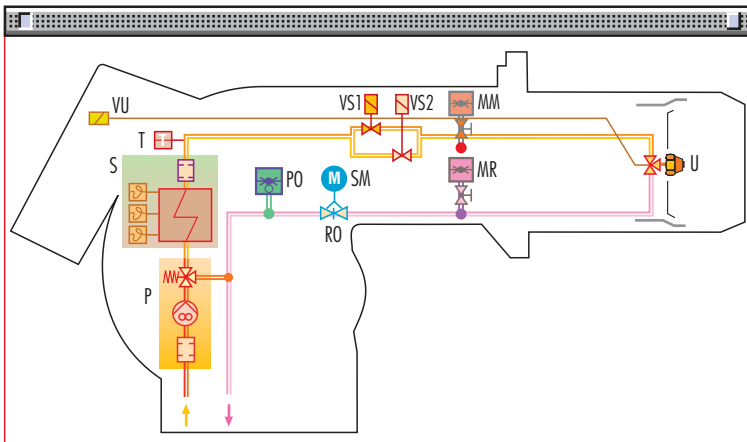

P	Pump with filter, heater and pressure regulator on the output circuit
S	Oil preheater with maximum, minimum and regulation thermostat
T	Thermometer
MM	Oil delivery gauge
SM	Servomotor
RO	Pressure regulator on the return circuit
PO	Oil pressure switch on the return circuit
U	Nozzle
MR	Pressure gauge on the return circuit
VU	Nozzle needle valve
VS _n	Delivery oil valves

VISCOSITY

The modulating burner P/N series can burn different heavy oil types from 50 up to 450 cSt @ 50°C (7 up to 60°E @ 50°C). For different viscosity levels Riello recommends 3 different configurations:

- 1) Press P/N version for viscosity up to 50 cSt (7°E) @ 50°C: basic version with 2800 rpm oil pump installed directly on fan motor shaft
- 2) Press P/N version for viscosity up to 200 cSt (25°E) @ 50°C: as basic version + heavy oil cartridges factory installed on nozzles, pump and valves group
- 3) Press P/N ECO version for viscosity up to 450 Cst (60°E) @ 50°C:
 - with separate 1400 rpm low speed pump
 - heavy oil cartridges factory installed on nozzles, pump and valves group
 - pipes heating cable factory installed.

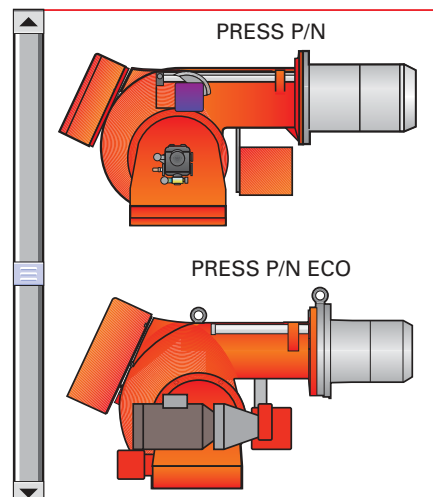



DIMENSIONING OF THE FUEL SUPPLY LINES

The fuel feed must be completed with the safety devices required by the local norms.

IMPORTANT NOTES

- The oil could easily flow through the pipes if those are properly sized, protected and heated (by electricity, steam or hot water)
- In order to limit gas or steam production the oil pressure into the gas separator shall be set in function of the supply temperature, see instructions manual.
- The forwarding pump should have at least a double capacity than that one of the burner. For several burners supplied through the same ring supply line, the forwarding pump should have a capacity of approximatively 30% more than the sum of the single burners outputs.

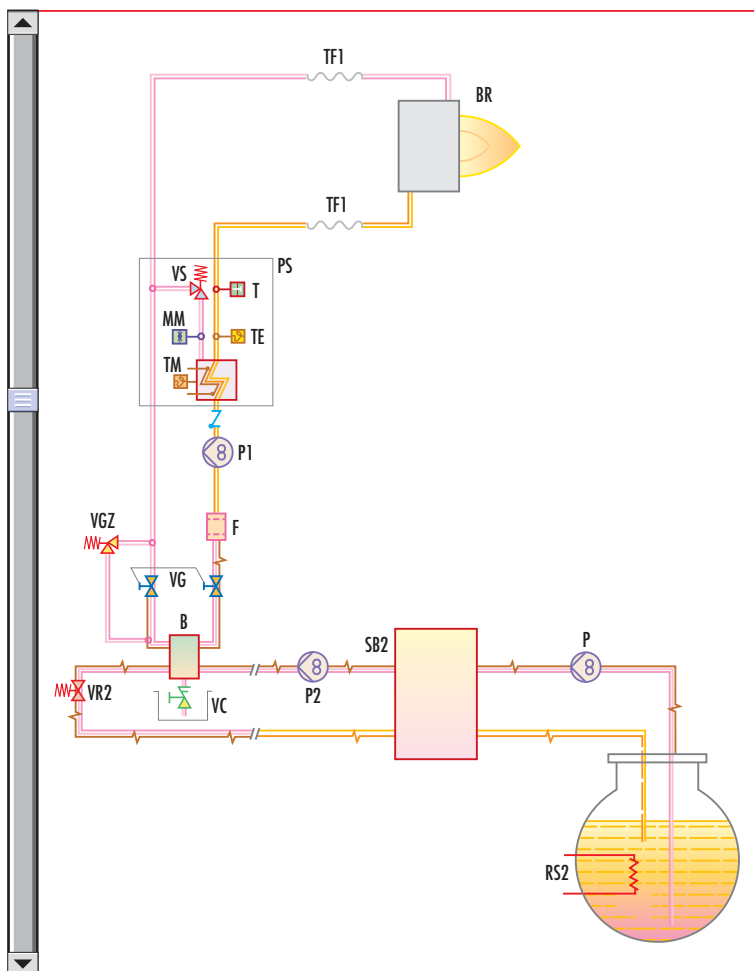

RS2	Tank heater
P	Double pumping unit with filter and heater on transfer ring
SB2	Service tank
P2	Double pumping unit with filter and heater on main ring
VR2	Oil valve – main ring
B	Gas separator bottle
VGZ	Safety valve – burner circuit
P1	Pump with heater – burner circuit
PS	Electrical preheater
VS	Preheater safety valve
BR	Burner
TF1	Flexible oil line
T	Thermometer
TM	Max oil temperature switch
TE	Temperature switch regulation
MM	Oil delivery gauge
VC	Vent valve
F	Oil filter



VENTILATION

The ventilation circuit is provided with a forward blades centrifugal fan, which guarantees high pressure levels at the required air deliveries and permits installation flexibility.

In spite of the remarkable output power and of the very high pressure performances, structures of PRESS models are extremely compact.

The use of sound proofing boxes helps in reducing the noise level.

A variable profile cam connects fuel and air setting, ensuring fuel efficiency in all firing rates.

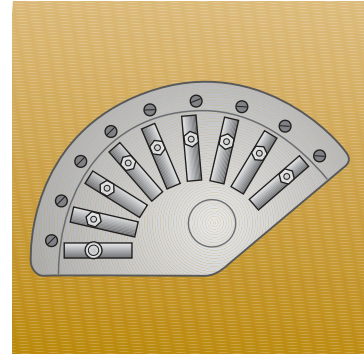

Example of servomotor for air/light oil setting



COMBUSTION HEAD

Two different lengths of the combustion head can be chosen for the various models of the PRESS P/N series of burners.

The choice depends on the thickness of the front panel and the type of the boiler.

Depending on the type of heat generator, it is necessary to check the correct head penetration into the combustion chamber.

The internal position of the combustion head can easily be adjusted: refer to the burner instruction manual for the complete procedure.

The following diagram shows the flame dimensions in relation to the burner output. The length and diameter shown in the diagram below should be employed preliminary check: it is required a more careful investigation if combustion chamber dimensions are much different from the above reported values.

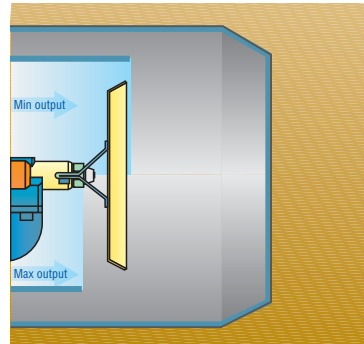

Example of a PRESS P/N burner combustion head

Dimensions of the flame

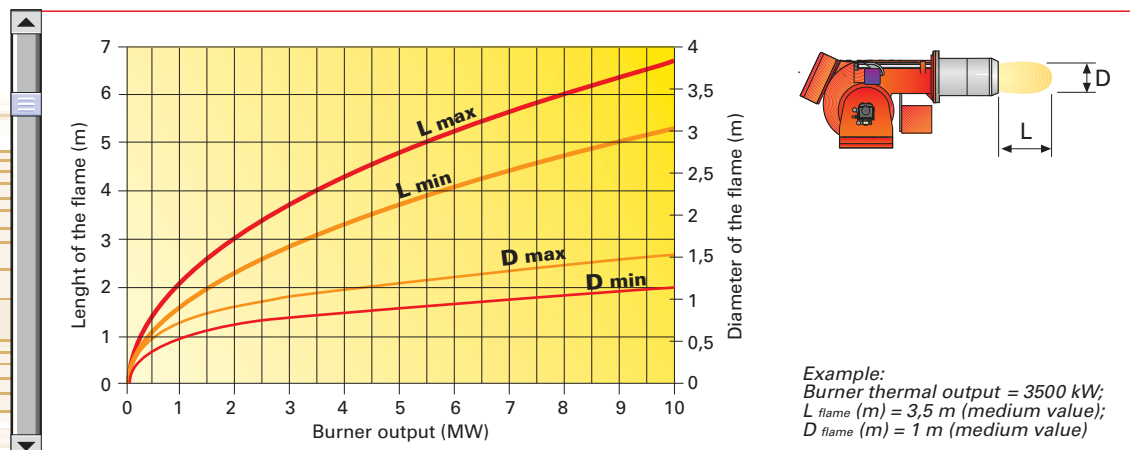

ADJUSTMENT



BURNER OPERATION MODE

The PRESS P/N series of burners can have "two stage progressive" or "modulating" operation.

On "two stage progressive" operation, the burner gradually adapts the output to the requested level, by varying between two pre-set levels (see picture A).

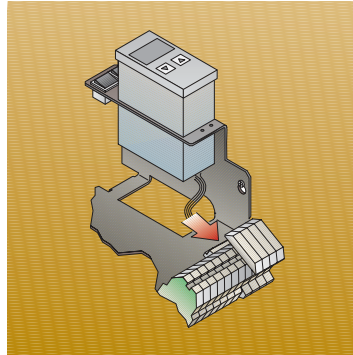

Example of a regulator

"Two stage progressive" operation

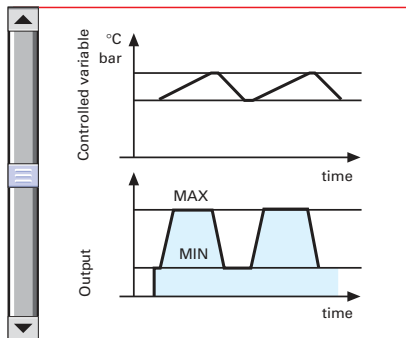

Picture A

On "modulating" operation, normally required in steam generators, in superheater boilers or diathermic oil burners, a specific regulator and probes are required. These are supplied as accessories that must be ordered separately. The burner can work for long periods at intermediate output levels (see picture B).

"Modulating" operation

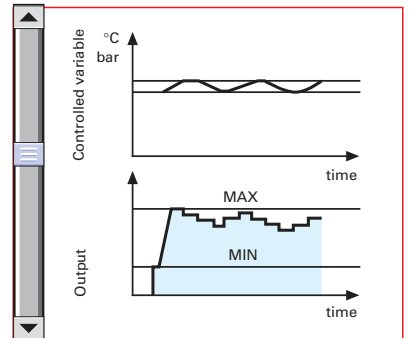

Picture B

FIRING

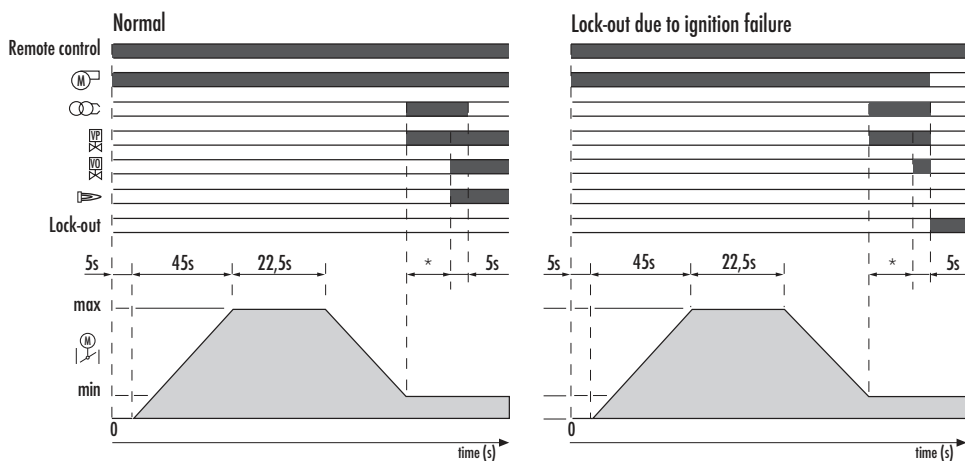

- 0" The burner begins the start-up cycle: the motor starts turning.
- 5"-50" The servomotor opens the air damper at the maximum position.
- 50"-72,5" Chamber pre-purge phase with air damper open.
- 72,5" The servomotor takes the fire damper to the firing position.
- 92,5" Ignition transformer turns on. Pre-purge valves opens and oil circuit pre-purge phase takes place.
- 95" Ignition valve opens and flame rilevation with P.E. cell is activated. (*)
- 100" After a safety time of 7,5" the ignition transformer turns down if there is the flame otherwise lock-out happens.

* Time adjustable with timer.





WIRING DIAGRAMS

Electrical connections must be made by qualified and skilled personnel, according to the local norms.

“TWO STAGE PROGRESSIVE” OPERATION

Direct start-up version P 140-200-300 P/N

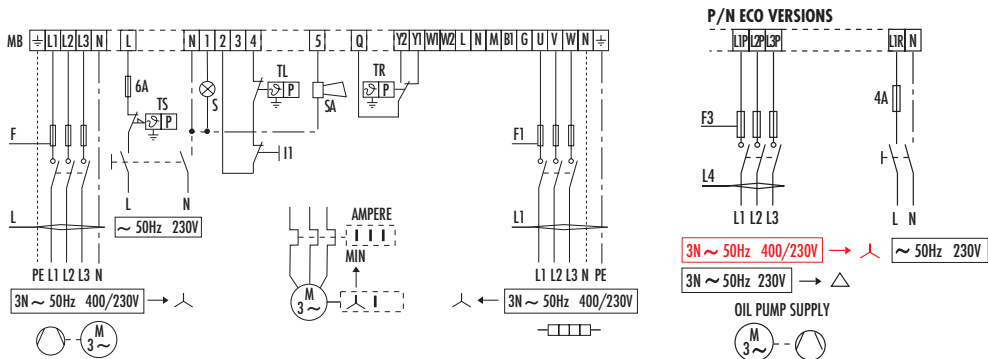

- MB** - Burner terminal board
- L, L1, L4** - Lead section (see table A)
- TS** - Safety thermostat
- S** - External lock-out signal
- TL** - Threshold thermostat
- TR** - High/low flame setting thermostat
- T6A** - 6A fuse
- F, F1, F3** - Fuse (see table A)
- I1** - Manual switch
- SA** - High temperature oil alarm

Star delta start-up version P 300-450 P/N

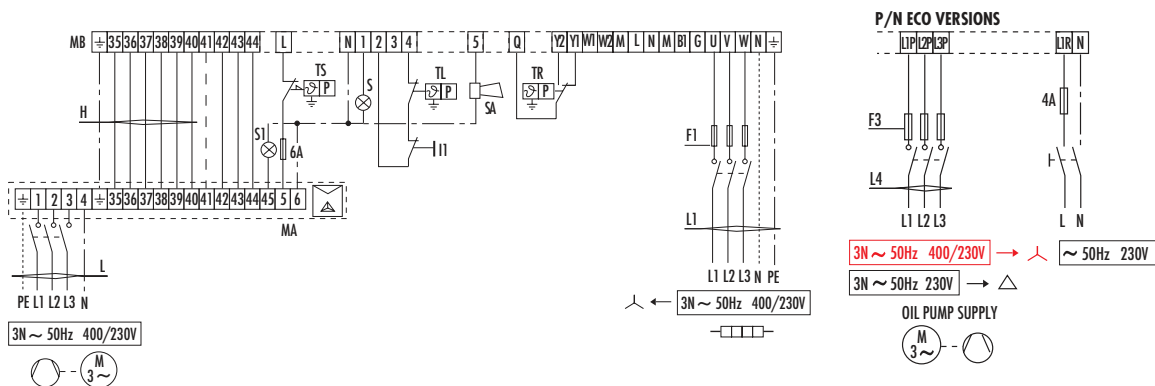

- MB** - Burner terminal board
- L, L1, L4, H** - Lead section (see table A)
- TS** - Safety thermostat
- S, S2** - External lock-out signal
- TL** - Threshold thermostat
- TR** - High/low flame setting thermostat
- T6A** - 6A fuse
- F, F1, F3** - Fuse (see table A)
- MA** - Star delta starter
- I1** - Manual switch
- SA** - High temperature oil alarm



"MODULATING" OPERATION - temperature probe

Direct start-up version P 140-200-300 P/N

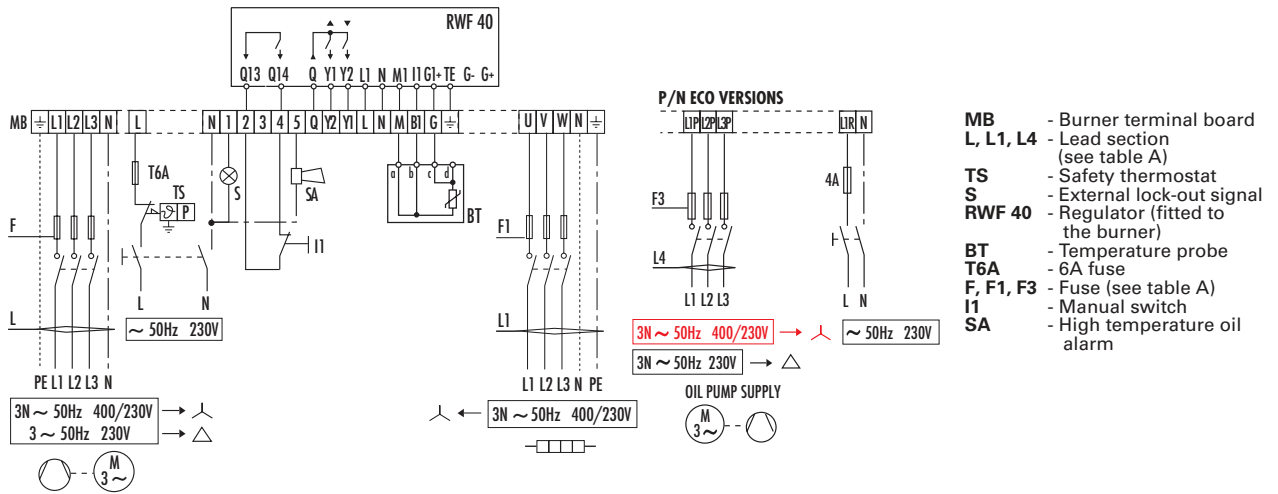

Star delta start-up version P 300-450 P/N

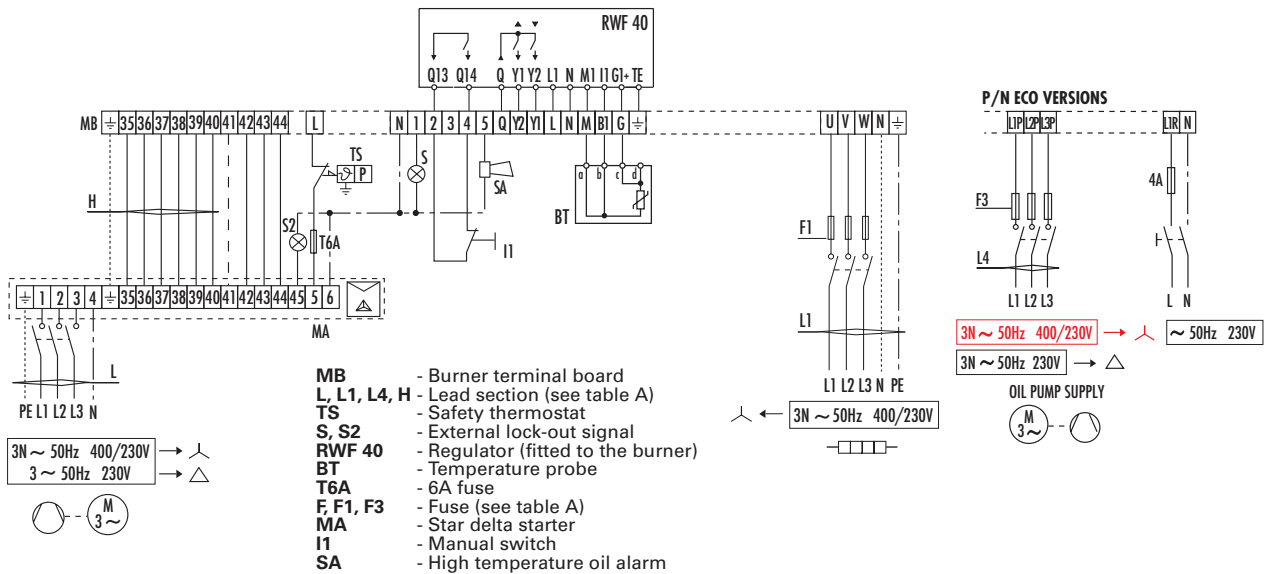

"MODULATING" OPERATION - pressure probe

Direct start-up version P 140-200-300 P/N

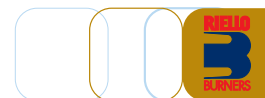
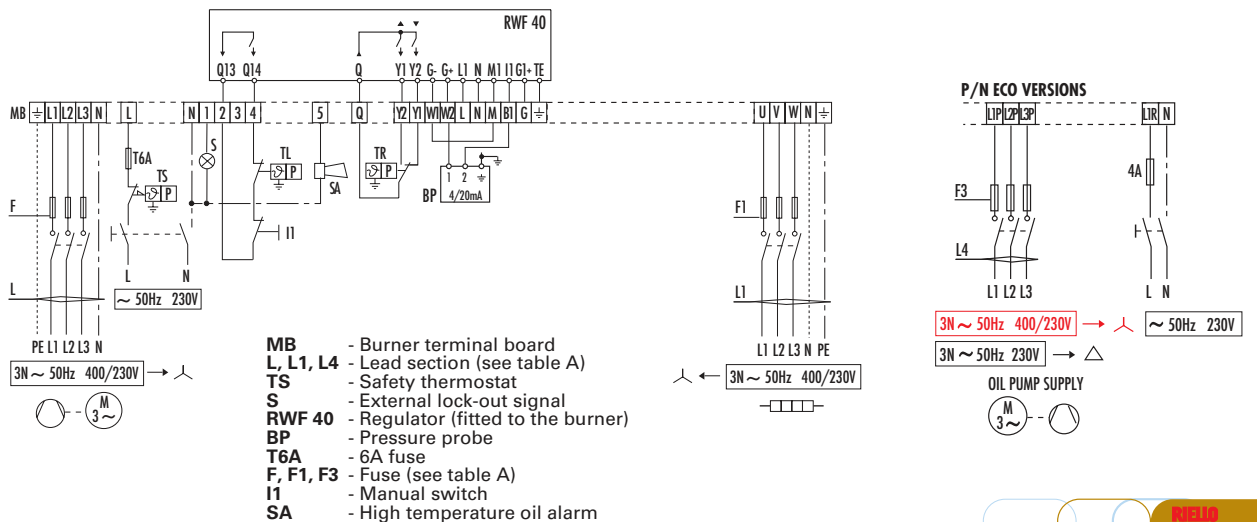

Star delta start-up version P 300-450 P/N

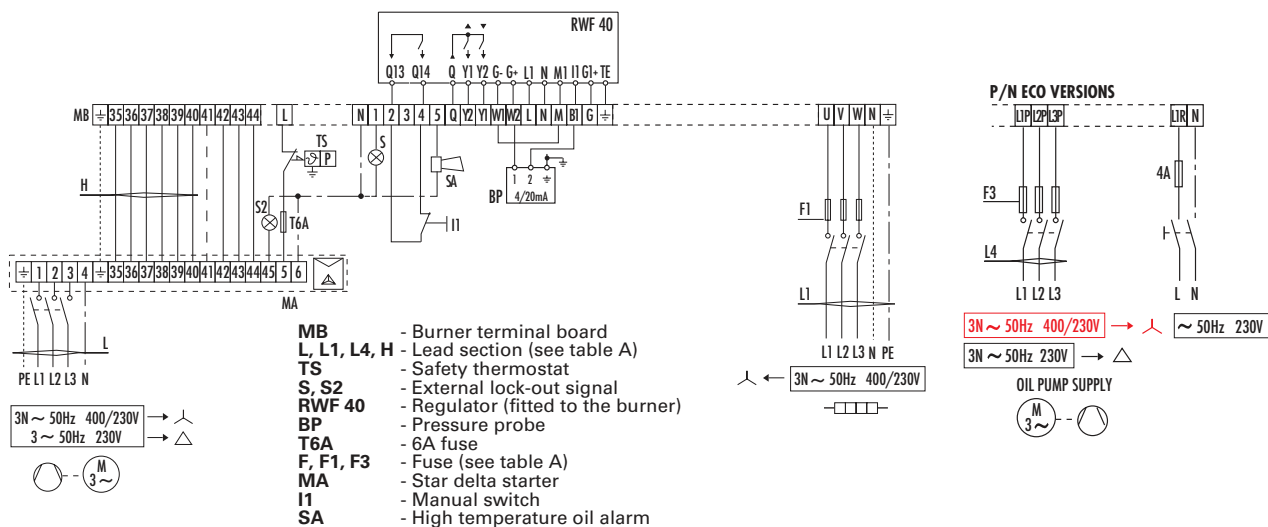

The following table shows the supply lead sections and the type of fuse to be used.

Model	Direct						Star delta			
	▼ P 140 P/N		▼ P 200 P/N		▼ P 300 P/N		▼ P 300 P/N		▼ P 450 P/N	
	230V	400V	230V	400V	230V	400V	230V	400V	230V	400V
F A	T25	T25	T35	T25	T63	T50	T50	T35	-	-
F1 A	T50	T35	T50	T35	T63	T50	T63	T50	T63	T50
F3 A	T10	T6	T10	T6	T10	T6	T10	T6	T10	T6
L mm ²	2,5	2,5	4	2,5	6	4	6	4	10	6
L1 mm ²	10	6	10	6	10	6	10	6	10	6
L4 mm ²	1,5	1,5	1,5	1,5	1,5	1,5	1,5	1,5	1,5	1,5
H mm ²	-	-	-	-	-	-	4	2,5	6	4

Table A

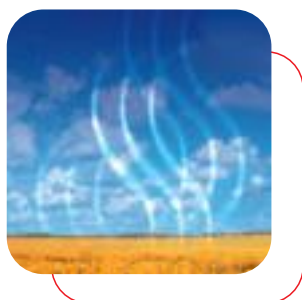

EMISSIONS

NO_x EMISSIONS

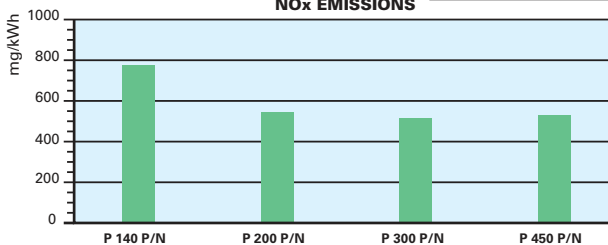

CO EMISSIONS

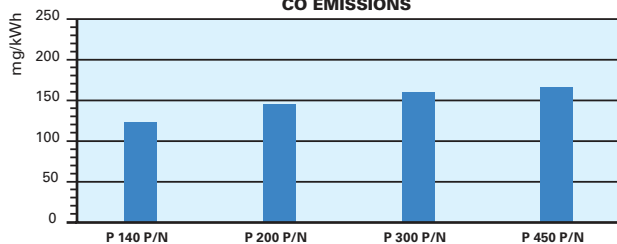

NOISE EMISSIONS

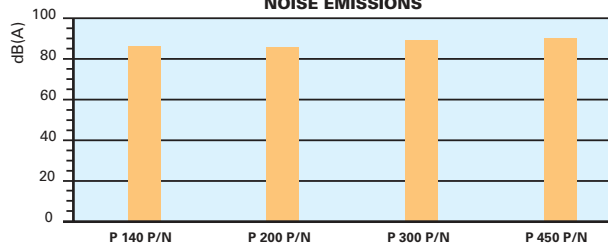

The emission data has been measured in the various models at maximum output, according to EN 267 standard.

OVERALL DIMENSIONS (mm)



BURNERS

PRESS P/N

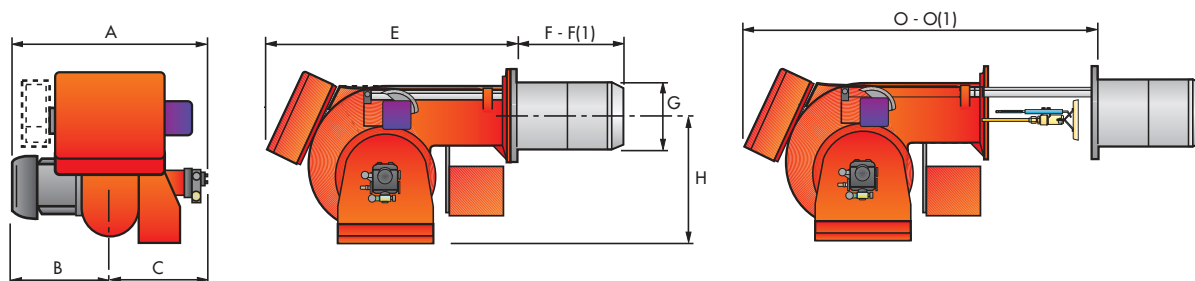

PRESS P/N ECO

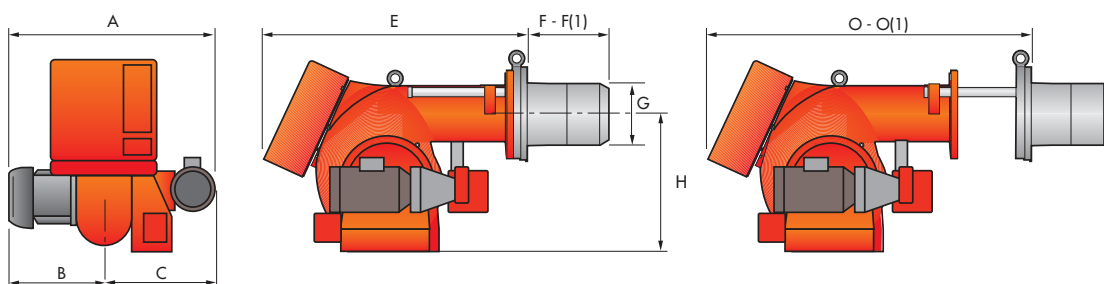

Model	A	B	C	E	F - F(1)	G	H	O - O(1)
▶ P 140 P/N	796	396	400	910	323 - 433	222	467	1390 - 1390
▶ P 200 P/N	796	396	400	910	352 - 462	250	467	1390 - 1390
▶ P 300 P/N	858	447	411	1020	376 - 506	295	496	1535 - 1685
▶ P 450 P/N	950	508	442	1090	435 - 565	336	525	1665 - 1820
▶ P 140 P/N ECO	900	396	504	890	323 - 433	222	467	1370 - 1370
▶ P 200 P/N ECO	900	396	504	890	352 - 462	250	467	1370 - 1370
▶ P 300 P/N ECO	984	447	537	1000	376 - 506	295	496	1515 - 1665
▶ P 450 P/N ECO	1100	508	592	1090	435 - 565	336	525	1665 - 1820

(1) Length with extended combustion head

BURNER - BOILER MOUNTING FLANGE

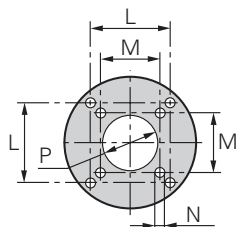

Model	L	M	N	P
▶ P 140 P/N (ECO)	260	230	M 14	225
▶ P 200 P/N (ECO)	260	-	M 16	255
▶ P 300 P/N (ECO)	260	-	M 18	300
▶ P 450 P/N (ECO)	310	-	M 20	350

PACKAGING

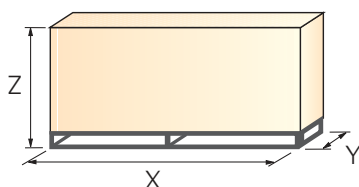

Model	X	Y	Z	kg
▶ P 140 P/N (ECO)	1500	930	900	180
▶ P 200 P/N (ECO)	1500	930	900	220
▶ P 300 P/N (ECO)	1780	1085	990	238
▶ P 450 P/N (ECO)	1780	1085	990	300





INSTALLATION DESCRIPTION

Installation, start-up and maintenance must be carried out by qualified and skilled personnel.
All operations must be performed in accordance with the technical handbook supplied to the burner.

▶ BURNER SETTINGS

- ▶ All the burners have slide bars, for easier installation and maintenance.
- ▶ After removing the cover, the split pin and the pin, the nuts and the screws, dismantle the blast tube from the burner of approximately 100-120mm and fix it to the boiler.
- ▶ Adjust the combustion head.
- ▶ Refit the burner casing to the slide bars.
- ▶ Install the nozzle, choosing it on the basis of the maximum boiler output and following the diagrams included in the burner instruction handbook.
- ▶ Check the position of the electrodes.
- ▶ Close the burner, fasten the screws, the nuts, the split pin and the pin.

▶ HYDRAULIC AND ELECTRICAL CONNECTIONS AND START-UP

- ▶ The burners are supplied for connection to two pipes fuel supply system.
- ▶ Connect the ends of the flexible pipes to the suction and return pipework using the supplied nipples.
- ▶ Make the electrical connections to the burner following the wiring diagrams included in the instruction handbook.
- ▶ Prime the pump by turning the motor (after checking rotation direction if it is a three phase motor).
- ▶ On start up, check:
 - Pressure pump and valve unit regulator (to max. and min.)
 - Combustion quality, in terms of not-burnt substances and excess air.



ACCESSORIES

Available for P/N and P/N ECO versions



Nozzles

The nozzles must be ordered separately. The following table shows the features and codes on the basis of the maximum required output.



NOTE: each burner needs N° 1 nozzle.

Nozzles			
Burner	Rated output kg/h	Nozzles Bergonzo B5 45° - with "AA" needle code	Nozzles Fluidics W2 45° - with "AA" needle code
P 140 P/N	70	3009203	3045426
P 140 P/N	80	3009205	3045427
P 140 P/N	90	3009207	3045428
P 140 P/N - P 200 P/N	100	3009209	3045430
P 140 P/N - P 200 P/N	125	3009211	3045432
P 200 P/N - P 300 P/N	150	3009213	3045434
P 200 P/N - P 300 P/N	175	3009215	3045436
P 200 P/N - P 300 P/N	200	3009800	3045438
P 200 P/N - P 300 P/N	225	3009801	3045440
P 300 P/N - P 400 P/N	250	3009802	3045442
P 300 P/N - P 400 P/N	275	3009803	3045444
P 300 P/N - P 400 P/N	300	3009804	3045446
P 450 P/N	325	3009805	3045448
P 450 P/N	350	3009806	3045450
P 450 P/N	375	3009807	3045452
P 450 P/N	400	3009808	3045454
P 450 P/N	425	3009809	3045455
P 450 P/N	450	3009810	3045456

Spacers kit

If burner head penetration in the combustion chamber needs reducing, varying thickness spacers are available, as given in the following table.

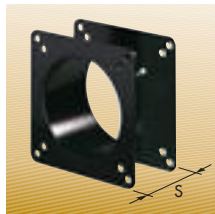

Spacers		
Burner	Spacer thickness S (mm)	Kit code
P 140 P/N - P 200 P/N	110	3000722
P 300 P/N	130	3000723
P 450 P/N	130	3000751

Sound proofing box

If noise emissions need reducing, sound proofing hoods are available, as given in the following table.



Sound proofing box			
Burner	Box type	Average noise reduction [dB(A)] (*)	Box code
P 140 P/N - P 200 P/N	C4/5	10	3010404
P 300 P/N - P 450 P/N	C7	10	3010376

(*) according to EN 15036-1 standard



Burner support

For easier maintenance, a mobile burner support has been designed, which means the burner can be dismantled without the need of forklift trucks.

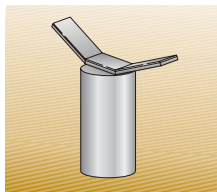

Support	
Burner	Code
P 300 P/N - P 450 P/N	3000731

Accessories for modulating operation

To obtain modulating operation, the PRESS P/N series of burners require a regulator, with three point outlet control. The relative temperature or pressure probes fitted with the regulator must be chosen on the basis of the application.

The following table lists the accessories for modulating setting with their application range.



REGULATOR		PROBES		
Type	Code	Type	Range (°C) (bar)	Code
RWF 40	3010211	Temperature PT 100	-100 ÷ 500°C	3010110
		Pressure 4 ÷ 20 mA	0 ÷ 2,5 bar	3010213
		Pressure 4 ÷ 20 mA	0 ÷ 16 bar	3010214

Analog control signal

Depending on the servomotor fitted to the burner, a three-pole potentiometer (0÷1000 W) can be installed to check the servomotor position. The kits available for the various burners are listed below:



Potentiometer kit	
Burner	Kit code
P 140 P/N - P 200 P/N - P 300 P/N - P 450 P/N	3010021

Gas separator bottle

It allows to recover heat in excess by discharge of the gas from the return circuit.



Gas separator bottle	
Burner	Degaser code
P 140 P/N - P 200 P/N	3000748
P 300 P/N - P 450 P/N	3010012

Heavy oil kit

Equipped with electrical heaters, it permits the employment of PRESS P/N burners with fuel oil of max. viscosity 25°E at 50°C.



Heavy oil kit	
Burner	Kit code
P 140 P/N - P 200 P/N - P 300 P/N - P 450 P/N	3000721



Heavy oil precirculation kit

This kit, used with oil with high viscosity, in maintains fuel circulation in the oil circuit for avoiding system stop at start up.

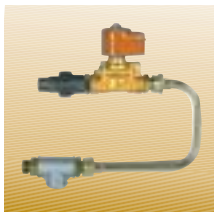

Heavy oil precirculation kit	
Burner	Code
P 140 P/N - P 200 P/N	3000749
P 300 P/N - P 450 P/N	3000750

Selfcleaning filter

For cleaning heavy oil from dirty particles and impurities, it is equipped with a thermostatic heater for oil with 60°E viscosity at 50°C.



FILTER		HEATERS AND THERMOSTATS	
Type	Code	Type	Code
Ø=1" 1/2 (60°E - 50°C)	3010022	Thermostatic heater with LED	3010060
		Heater	3010061
		Thermostat (two-stage / regulable)	3010062

Cartridge filter

For cleaning heavy oil from dirty particles and impurities, it is equipped with a cartridge system for oil with 7°E viscosity at 50°C.



Cartridge filter	
Burner	Filter code
P 140 P/N - P 200 P/N - P 300 P/N - P 450 P/N	3005209



▶ PRODUCT SPECIFICATION

Burner:

Monoblock forced draught oil burner with two-stage progressive or modulating operation, with a specific kit, fully automatic, made up of:

- Air suction circuit lined with sound-proofing material
- Fan with forward curved blades high performance pressure levels
- Air damper for air setting and automatic oil output regulator controlled by a servomotor with variable cam
- Fan motor at 2850 rpm, three-phase 400V with neutral, 50Hz
- Combustion head, that can be set on the basis of the combustion output, fitted with:
 - stainless steel end cone, resistant to corrosion and high temperatures
 - ignition electrodes
 - flame stability disk
- Gears pump for high pressure fuel supply, fitted with:
 - filter
 - pressure regulator
 - connections for installing a pressure gauge and vacuumeter
 - internal by-pass for single pipe installation
- Heavy oil kit cartridges (for P/N version viscosity 7°E @ 50°C and for P/N ECO version)
- Pipes heating cable (P/N ECO version)
- Oil pump motor at 1400 rpm (P/N ECO version)
- Valve unit with a double oil safety valve on the output circuit
- Electrical preheater for heavy oil
- Safety oil pressure switch
- Photocell for flame detection
- Flame control panel, fitted with control function for the correct positioning of the servomotor and possibility of post-ventilation by just changing the electric wiring
- Flame inspection window
- Slide bars for easier installation and maintenance
- Protection filter against radio interference
- IP 40 electric protection level.

Conforming to:

- 89/336/EC directive (electromagnetic compatibility)
- 73/23/EEC directive (low voltage).

Standard equipment:

- 2 flexible pipes for connection to the oil supply network
- 2 nipples for the connection to the pump
- Wiring looms fittings for electrical connections
- 4 screws for fixing the burner flange to the boiler
- Instruction handbook for installation, use and maintenance
- Spare parts catalogue
- 2 slide bar extensions (for the extended head models of P 300 P/N e P 450 P/N)
- Gasket for flange
- Starter*

* for versions with star-delta starting

Available accessories to be ordered separately:

- Return nozzles
- Head length reduction kit (spacer)
- Sound-proofing box
- RWF 40 output regulator
- Pressure probe 0-2,4 bar
- Pressure probe 0-16 bar
- Temperature probe -100-500°C
- Potentiometer kit for the servomotor
- Burner support
- Gas separator bottle
- Selfcleaning filter
- Heavy oil kit
- Heavy oil precirculation kit
- Cartridge filter.







RIELLO S.p.A. - Via Ing. Pilade Riello, 5 - 37045 Legnago (VR) Italy
Tel. ++39.0442630111 - Fax ++39.044221980

Internet: <http://www.rielloburners.com> - E-mail: info@rielloburners.com

Since the Company is constantly engaged in the production improvement, the aesthetic and dimensional features, the technical data, the equipment and the accessories can be changed.
This document contains confidential and proprietary information of RIELLO S.p.A.
Unless authorised, this information shall not be divulged, nor duplicated in whole or in part.

