

TWO STAGE LIGHT OIL BURNERS

► **GULLIVER RGD SERIES**

► RG1RKD	14/17 ÷ 60 kW
► RG2D	42/49 ÷ 118 kW
► RG3D	65/83 ÷ 178 kW
► RG4D	106/130 ÷ 237 kW
► RG5D	95/142 ÷ 296 kW

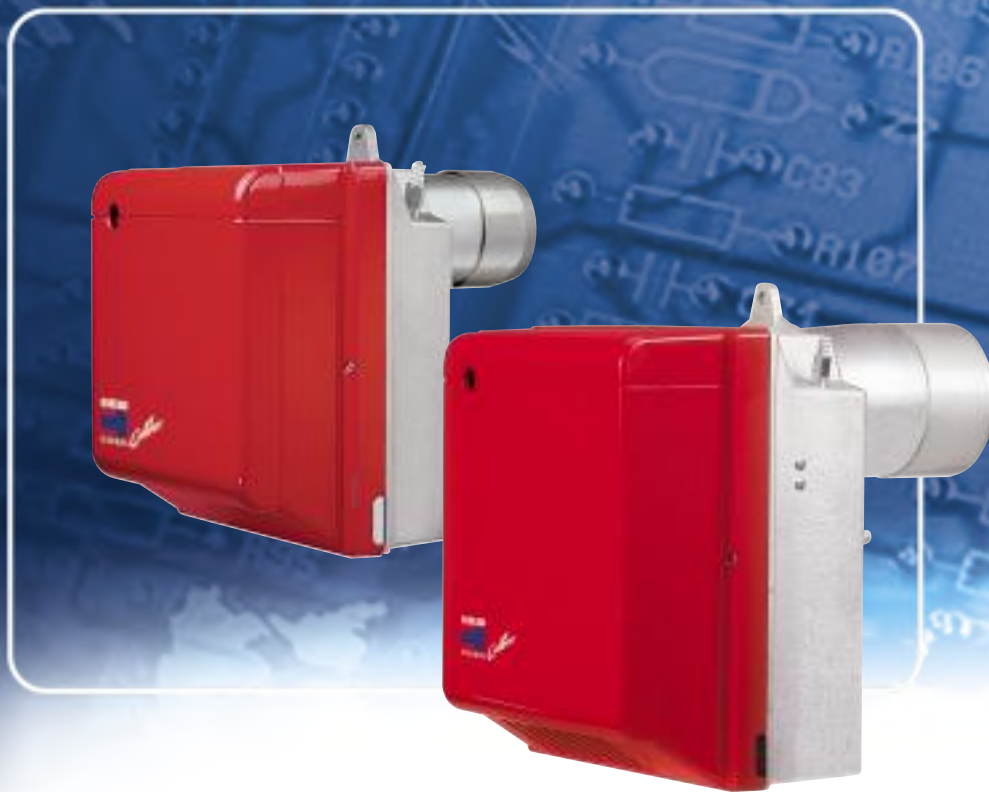

The Riello Gulliver RGD series of two stage light oil burners, is a complete range of products developed to respond to any request for home heating. The Gulliver RGD series is available in five different models, with an output ranging from 14 to 296 kW, divided in four different structures.

All the models use the same components designed by Riello for the Gulliver series. The high quality level guarantees safe working.

In developing these burners, special attention was paid to reducing noise, to the ease of installation and adjustment, to obtaining the smallest size possible to fit into any sort of boiler available on the market.

The two stage working guarantees high level of thermal unit efficiency.

All the models are approved by the EN 267 European Standard and conform to European Directives for EMC, Low Voltage, Machinery and Boiler Efficiency.

All the Gulliver RGD burners are fired before leaving the factory.



TECHNICAL DATA

Model		▼ RG1RKD	▼ RG2D	▼ RG3D	▼ RG4D	▼ RG5D
Burner operation mode		Two stage				
Modulation ratio at max. output		--				
Servomotor	run time	--				
	type	--				
Heat output	kW	14/17 - 60	42/49 - 118	65/83 - 178	106/130 - 237	95/142 - 296
	Mcal/h	12/14,6 - 51,6	36,1/42,1 - 101,4	55,9/71,4 - 153	91,2/111,8 - 203,8	81,7/122,1 - 254,6
	kg/h	1,2/1,45 - 5	3,6/4,1 - 10	5,5/7 - 15	9/11 - 20	8/12 - 25
Working temperature		°C min./max. 0/40				
Net calorific value		kWh/kg 11,8				
Viscosity		kcal/kg 10200				
Pump		mm ² /s (cSt) 4 ÷ 6 (at 20°C)				
Pump	type	R.B.L.				
	delivery	kg/h 30 (at 12 bar)				35 (at 12 bar)
Atomised pressure		bar 8 ÷ 15				
Fuel temperature		max. °C 50				
Fuel pre-heater		YES		NO		
Fan		type Centrifugal with forward curve blades				
Air temperature		max. °C 40				
Electrical supply		Ph/Hz/V 1/50/230 ±10%				
Auxiliary electrical supply		Ph/Hz/V --				
Control box		type R.B.L. 553 SE R.B.L. 552 SE R.B.L. 552 SE R.B.L. 552 SE R.B.L. 552 SE				
Total electrical power		kW 0,290 0,180 0,390 0,390 0,470				
Auxiliary electrical power		kW -- -- -- -- --				
Heaters electrical power		kW 0,12 (PTC) -- -- -- --				
Protection level		IP 40				
Pump motor electrical power		kW --				
Rated pump motor current		A --				
Pump motor start up current		A --				
Pump motor protection level		IP --				
Fan motor electrical power		kW 0,09 0,09 0,15 0,15 0,25				
Rated fan motor current		A 0,85 0,9 1,9 2 2,1				
Fan motor start up current		A 3,4 3,6 7,6 8 8,4				
Fan motor protection level		IP 20				
Ignition transformer		type Incorporated in the control box				
		V1 - V2 (-) - 8 kV				
		I1 - I2 (-) - 22 mA				
Operation		Intermittent (at least one stop every 24 h)				
Sound pressure		dB (A) 60 61 64 64 71				
Sound power		W --				
CO emission		mg/kWh <60				
Grade of smoke indicator		N° Bacharach <1				
C_xH_y emission		mg/kWh <10 (after the first 20 s)				
NOx emission		mg/kWh <250				
Directive		89/336/EEC, 73/23/EEC, 98/37/EEC, 92/42/EEC				
Conforming to		EN 267				
Certification		DIN-Reg.-Nr. 5G237/98	DIN-Reg.-Nr. 5G263/98	CE-0036 0298/00	DIN-Reg.-Nr. 5G266/98	CE-0036 0325/01

Reference conditions:

Temperature: 20 °C

Pressure: 1013,5 mbar

Altitude: 100 m a.s.l.

Noise measured at a distance of 1 meter.

Since the Company is constantly engaged in the production improvement, the aesthetic and dimensional features, the technical data, the equipment and the accessories can be changed.

This document contains confidential and proprietary information of RIELLO S.p.A. Unless authorised, this information shall not be divulged, nor duplicated in whole or in part.

FIRING RATES

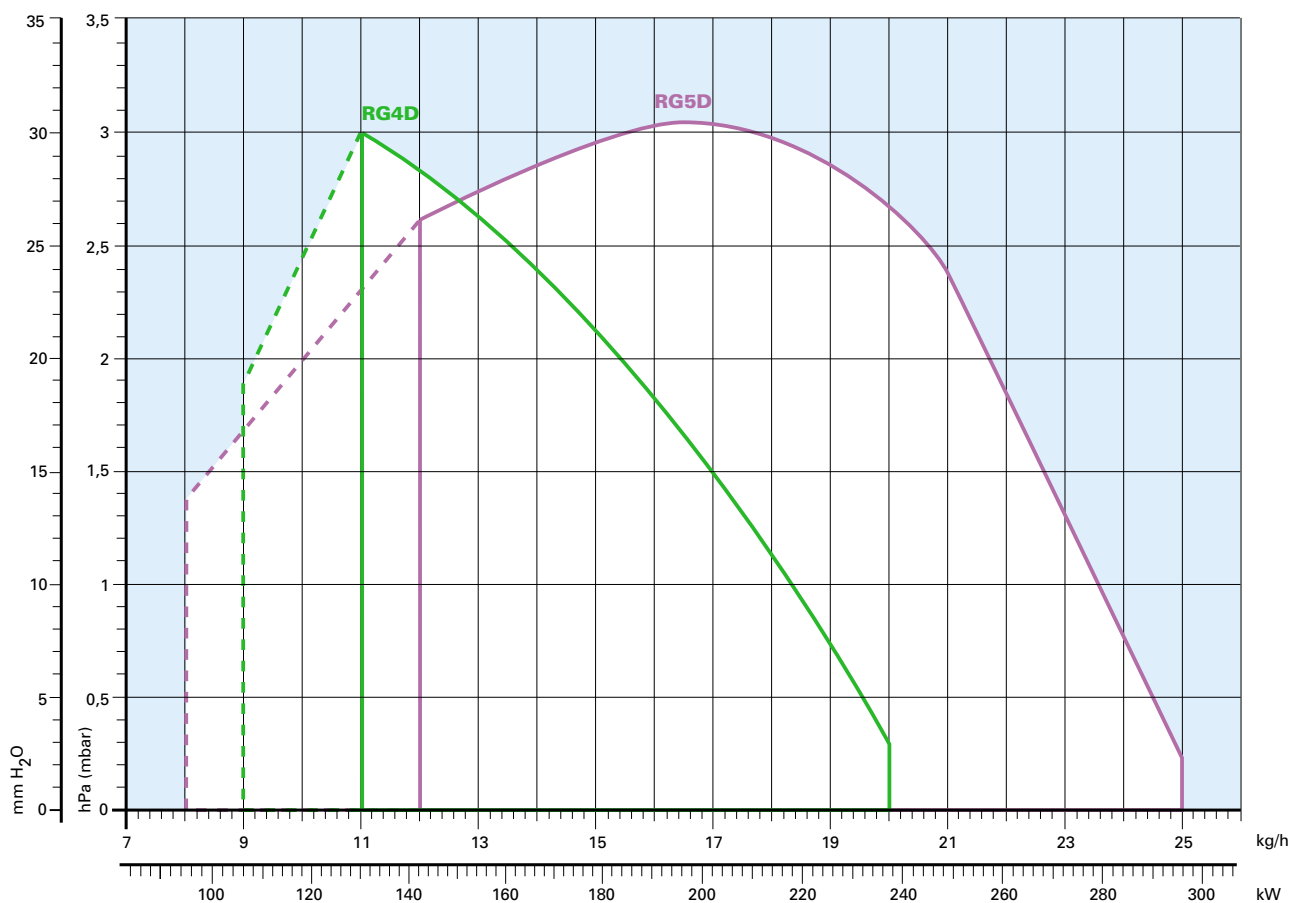
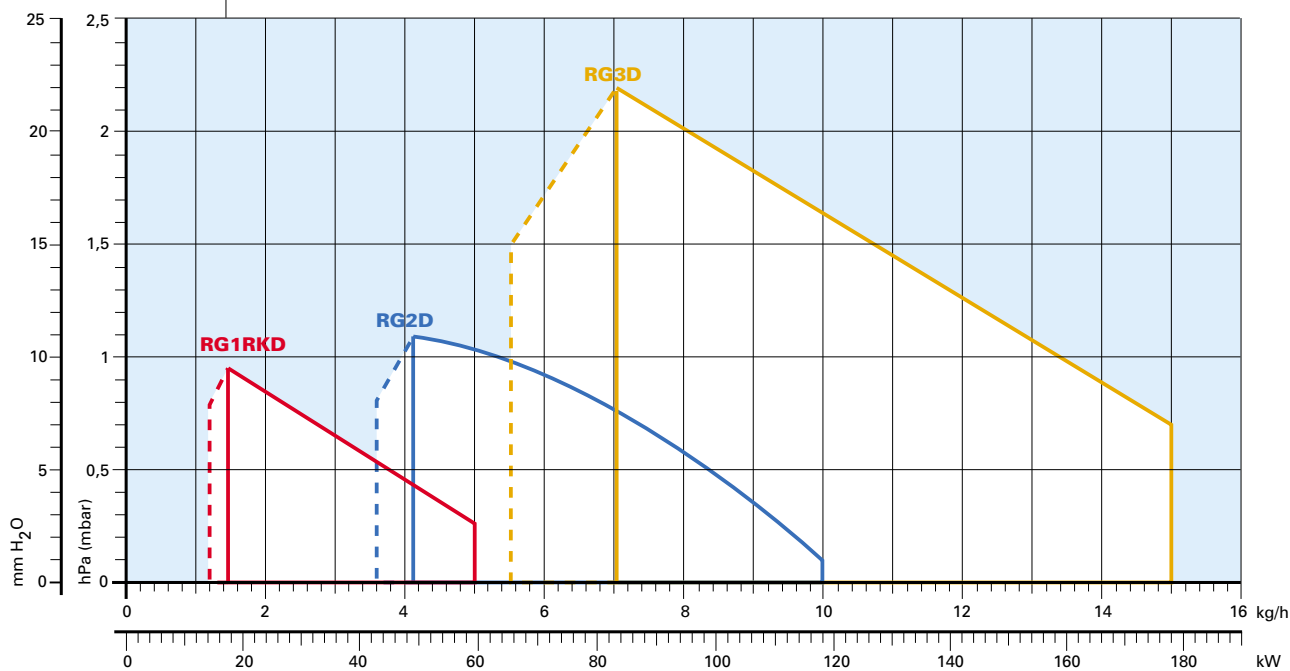

 Useful working field for choosing the burner

 1st stage operation range

Test conditions conforming to EN 267:
 Temperature: 20 °C
 Pressure: 1013,5 mbar
 Altitude: 100 m a.s.l.





FUEL SUPPLY

HYDRAULIC CIRCUIT

All the burners have a geared pump R.B.L. with double safety valve on the return circuit; the model RG1RKD is equipped by light oil pre-heater PTC type.



Fuel pump



Fuel pump (RG5D)

RG1RKD - RG2D - RG3D - RG4D

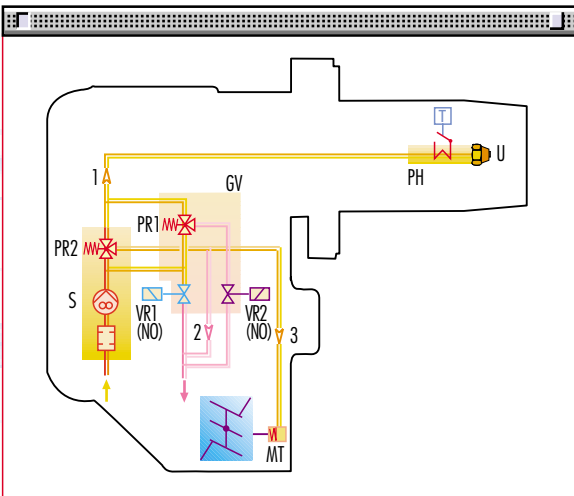

RG5D

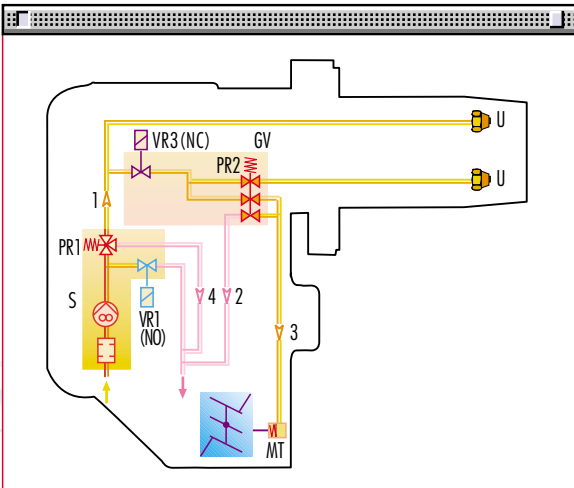

S	Pump with filter and pressure regulator on the delivery pipework
VR1(NO)	1 st stage oil return valve normally open
VR2(NO)	2 nd stage oil return valve normally open
VR3(NC)	2 nd stage oil return valve normally closed
1	Oil delivery pipe to the nozzle/s
2	Oil return pipe from the 2 nd stage regulator
3	Oil delivery pipe to the air damper hydraulic jack
4	Oil return pipe from the 1 st stage regulator
MT	Air damper hydraulic jack for the 2 nd stage
PR1	1 st stage oil regulator
PR2	2 nd stage oil regulator
PH	Oil pre-heater with thermostat (where provided)
GV	Valve unit
U	Nozzle

Fuel feed to the burner can be from the right or the left side on all models.



SELECTING THE FUEL SUPPLY LINES

The fuel feed must be completed with the safety devices required by the local regulations in force.

The table shows the choice of piping diameter for the various burners, depending on the difference in the height between the burner and the tank and the distance between them.

MAXIMUM EQUIVALENT LENGTH OF THE PIPEWORK L[m]				
Pipe size	Type A system		Type B system	
	Ø8mm	Ø10mm	Ø8mm	Ø10mm
H (m)	L _{max} (m)	L _{max} (m)	L _{max} (m)	L _{max} (m)
0	35	100	-	-
0,5	30	100	10	20
1,0	25	100	20	40
1,5	20	90	40	80
2,0	15	70	60	100
3,0	8	30	-	-
3,5	6	20	-	-

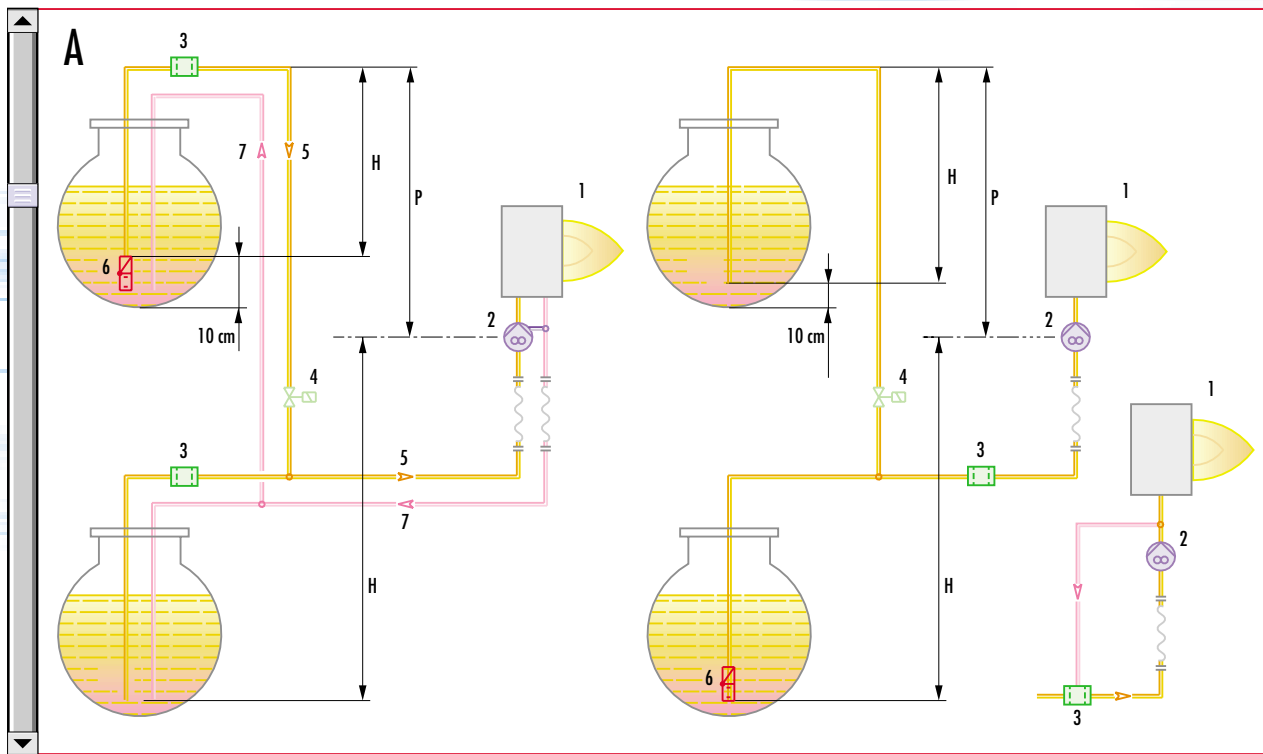

Type of system that can be installed

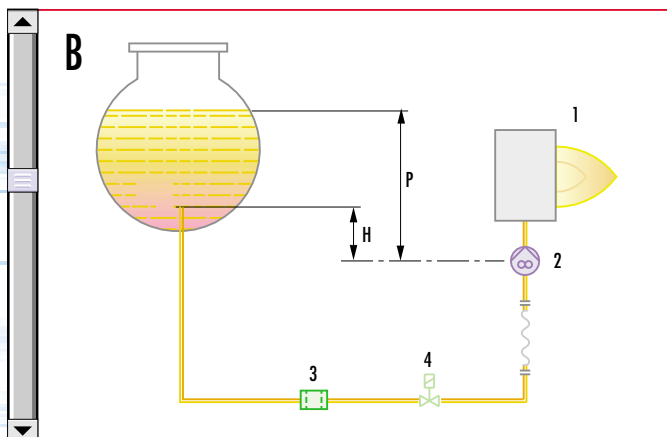

H	Difference in height
Ø	Internal pipe diameter
P	Difference in height ≤ 4 m
1	Burner
2	Pump
3	Filter
4	Shut-off solenoid valve
5	Suction pipework
6	Bottom valve
7	Return pipework



VENTILATION

The different ventilation circuits always ensure low noise levels with high performance of pressure and air delivery, inspite of their compact size.



Combustible air suction



COMBUSTION HEAD

The RGD series of burners allows you to choose the length of the combustion head.

This choice depends on the thickness of the front wall and the type of the boiler.

Depending on the type of generator, you should check the correct penetration of the head into the combustion chamber.

Simple adjustment to the combustion head allows adapting internal geometry of the head to the maximum rated output of the burner.



Combustion head



Combustion head (RG5D)

Dimensions of the flame

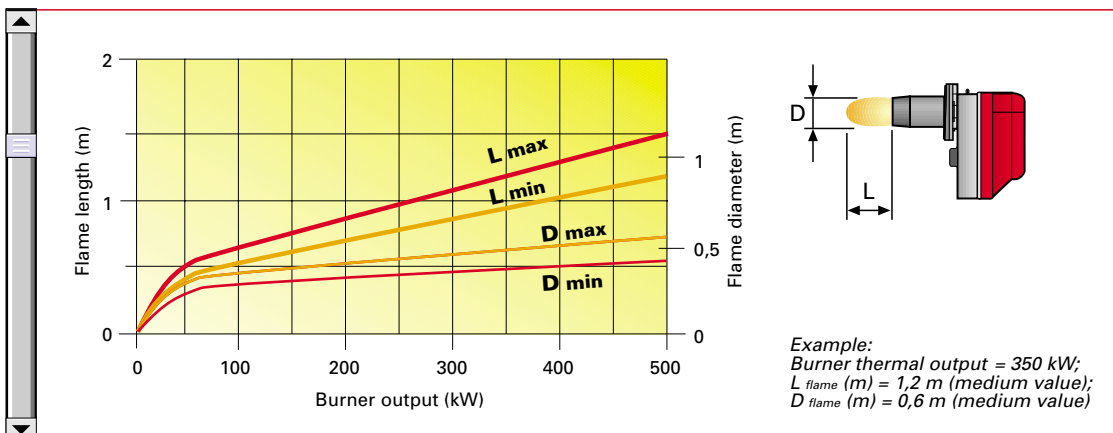

ADJUSTMENT



BURNER OPERATION MODE

All these models have two stage output operation at 2 pressure levels (each having its respective pressure regulator) except for the RG5D model, which has 2 nozzles (one for each stage) that work at the same pressure.

"Two stage" operation

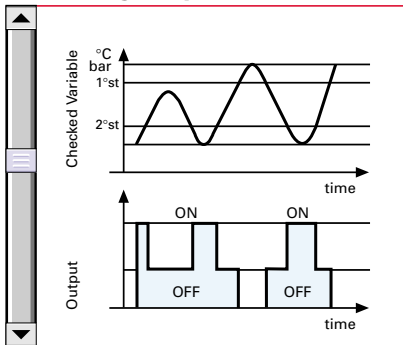

2nd stage air damper adjustment



1st stage air damper adjustment



Light oil pressure adjustment

START UP CYCLE

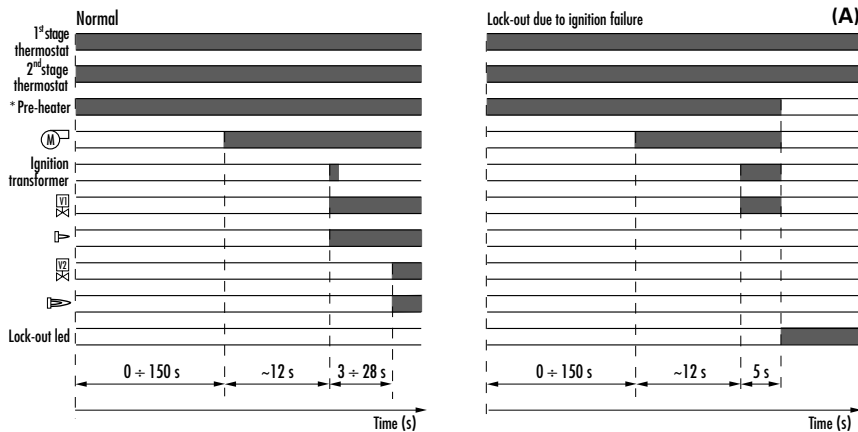

* Only for RG1RKD.

(A) Lock-out is shown by a led on the appliance.

Correct operation

- 0s The burner begins the ignition cycle.
- 0s-12s Pre-purge with the air damper open.
- 12s 1st stage ignition.
- 15s-40s 2nd stage ignition.

* If the pre-heater is fitted (RG1RKD model), there is a further delay before pre-purge; this delay can reach 150s depending on room and fuel temperatures.

Lock-out due to ignition failure

If the flame does not light within the safety limit (~ 5s) the burner locks-out.



WIRING DIAGRAMS

Electrical connections must be made by qualified and skilled personnel in conformity with the local regulations in force.



Appliance fitted with an ignition transformer

▶ "TWO STAGE" OPERATION

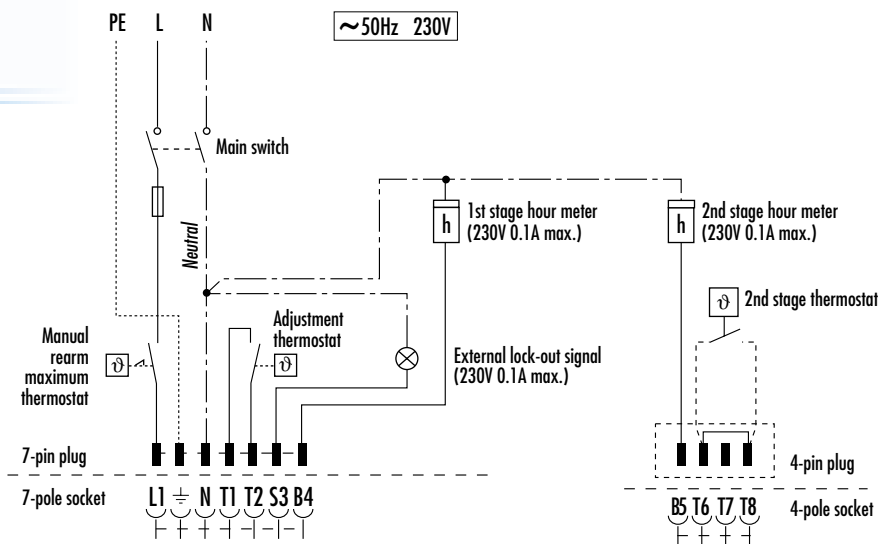

The following table shows the supply lead sections and types of fuse to be used.

Model	▼ RG1RKD	▼ RG2D	▼ RG3D	▼ RG4D	▼ RG5D
F A	6	6	T6	T6	T6
L mm ²	1	1	1	1	1

F = Fuse

L = Lead section

EMISSIONS

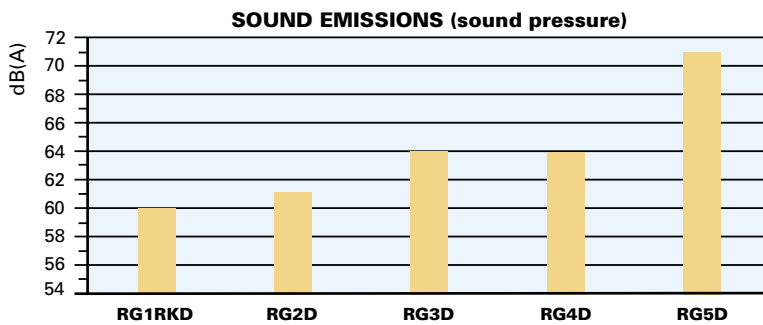
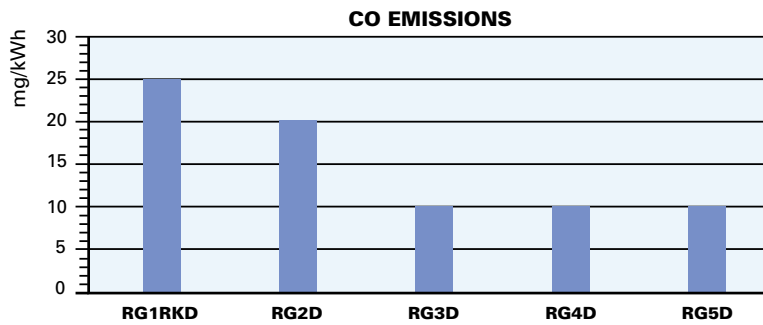
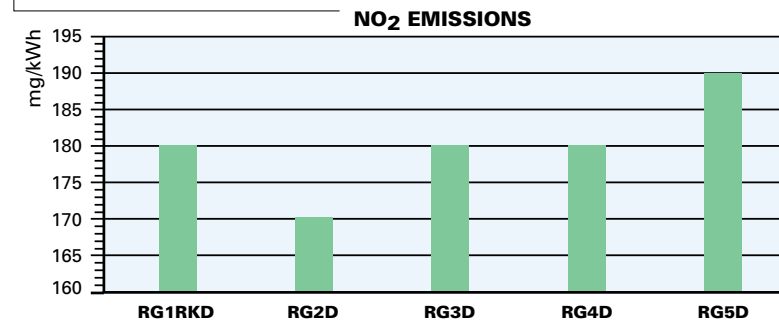

The emission data have been measured in the various models at maximum output, in conformity with EN 267 standard.

Special attention has been paid to noise reduction. All models are fitted with sound-proofing material inside the cover.

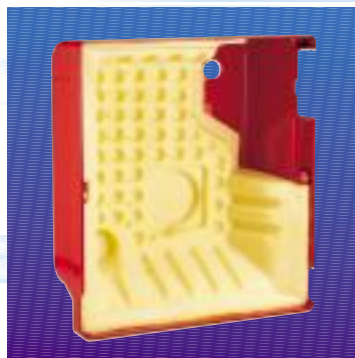



OVERALL DIMENSIONS (mm)

These models are distinguished by their reduced size, in relation to their outputs, which means they can be fitted to any boiler on the market.

BURNER

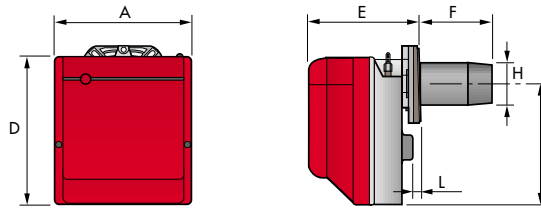

Model	A	D	E	F	H	I	L
▶ RG1RKD	234	254	196	111	84	210	4
▶ RG2D	255	280	202	115	95	230	10
▶ RG3D	300	345	228	142	123	285	12
▶ RG4D	300	345	228	142	123	285	12
▶ RG5D	300	345	247	159	125	285	12,5

BURNER-BOILER MOUNTING FLANGE

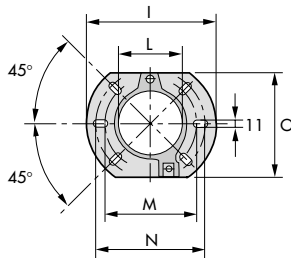

Model	I	L	M	N	O
▶ RG1RKD	180	91	130	150	144
▶ RG2D	189	106	140	165	166
▶ RG3D	213	127	160	190	198
▶ RG4D	213	127	160	190	198
▶ RG5D	213	127	160	190	198

PACKAGING

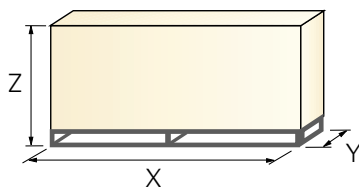

Model	X	Y	Z	kg
▶ RG1RKD	343	268	310	12
▶ RG2D	353	288	340	13
▶ RG3D	420	335	420	12
▶ RG4D	420	335	420	13
▶ RG5D	500	335	430	18



INSTALLATION DESCRIPTION



Skilled and qualified personnel must perform installation, start up and maintenance. A nozzle (2 for the RG5D) is fitted to the burner and used for fire tests in the factory. If necessary, change the nozzle on the basis of the maximum output of the boiler. All operations must be carried out as described in the technical handbook supplied with the burner.



▶ BURNER SETTING

- ▶ 2nd stage air damper position adjustment can be made without removing the burner casing
- ▶ 1st stage air damper position adjustment
- ▶ Head setting area is easily accessible and the operation is simple thanks to a graduated scale.

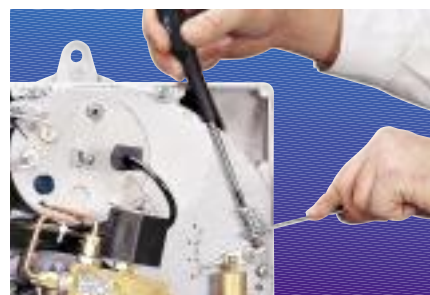

▶ MAINTENANCE AND ELECTRICAL CONNECTIONS

- ▶ The maintenance position is easily carried out by hooking the burner to the flange after removing it from the fixing screw.
- ▶ The nozzle holder can be serviced through the rear cover, without detaching the burner from the boiler.



- ▶ The 7-pole socket is incorporated in the control box, the 4-pole socket is already connected.
The 4 and 7-pin plugs are also supplied for connection to the boiler.



BURNER ACCESSORIES

Extended head kit

Kits of extended heads are available.

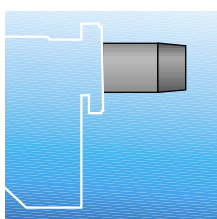

Extended head kit			
Burner	Standard head length (mm)	Long head length (mm)	Kit code
RG1RKD	111	181	3000982
RG2D	115	180	3000964
RG2D	115	300	3000967
RG3D	142	210	3000965
RG3D	142	300	3000968
RG4D	142	210	3000966
RG4D	142	300	3000969
RG5D	159	300	3000981

Spacer kit

By using the special accessories, the burner can be withdrawn to reduce head penetration into the combustion chamber.

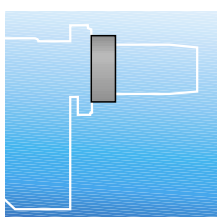

Spacer kit		
Burner	Spacer thickness S (mm)	Kit code
RG1RKD	15	3007931
RG2D	25	3000672
RG3D - RG4D - RG5D	25	3000673

Control box 550 SMD and sensor flame

On request, we can supply the control box used on the Low NOx models, which is interchangeable with the one fitted.

This control box has the following features:

- Spark restoration function
- Switch for burner post-ignition/recycling
- Leds signalling the various working stages
- Post-combustion lock-out
- Socket for remote resetting.



Control box 550 SMD and sensor flame	
Burner	Kit code
RG1RKD - RG2D - RG3D - RG4D - RG5D	3001168 + 3007492

Tester

The tester controls the correct working of the burner components in the GULLIVER series. It can be fitted to all the light oil models, with or without pre-heater.

It is made up of two parts: a control instrument and a "control box" which replaces and simulates the one on the burner.

This tester is very simple to use: just replace the burner control box with the tester to check correct working of the motor, valve, pre-heater and flame probe (only photo-resistance).

This device has a display showing the levels that have been measured, a selection switch for selecting the component to be tested and four switches to be used in the various working stages of the burner.











The following control boxes can be tested:

- 550 SMD
- 553 SE
- 552 SE



Tester	
Burner	Kit code
RG1RKD - RG2D - RG3D - RG4D - RG5D	3087211



Direct testing	Measurements
 MOTOR The switch feeds the motor.	 L1-N Main voltage (230 V)
 VALVE The switch feeds electromagnetic winding of the coil. A red led signals excitation stage, and a green led signals retainer stage.	  Pre-heater current consumption
 PRE-HEATER The switch feeds the light oil pre-heater; a green led signals the thermostat cut-in.	  Secondary voltage (low voltage)
 TRANSFORMER The switch feeds the firing transformer inside the control box and excites the oil valve.	  Photo-resistance current consumption



SPECIFICATION

A special index will help you choose the right burner from the RGD models available. There is also a clear and detailed product specification and description.

DESIGNATION OF SERIES

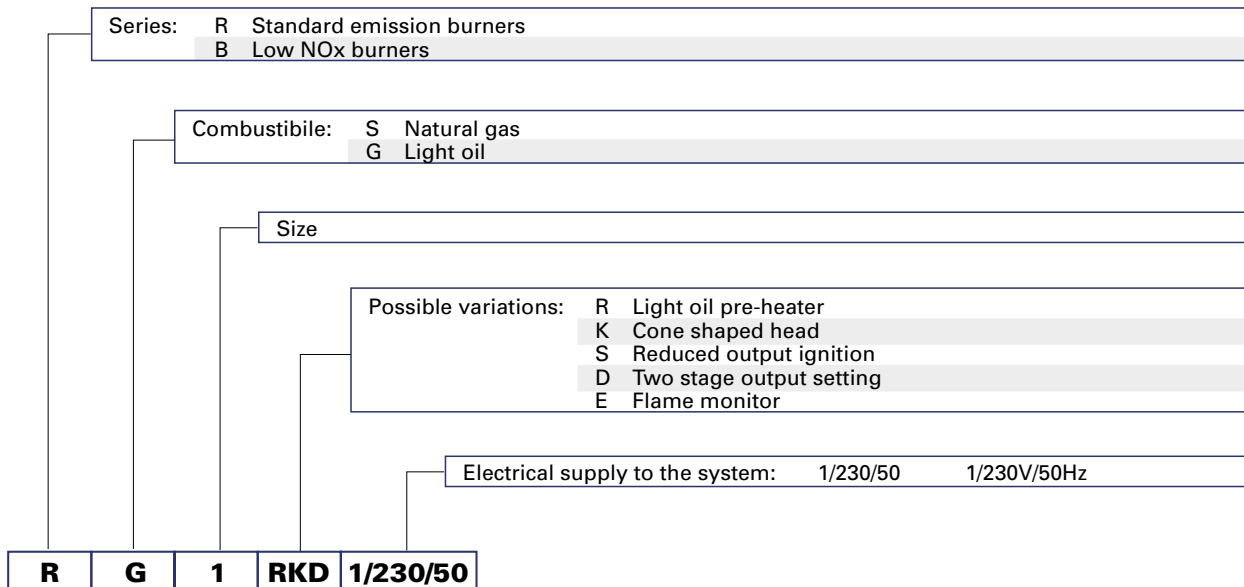

AVAILABLE BURNER MODELS

RG1RKD	1/230/50
RG2D	1/230/50
RG3D	1/230/50
RG4D	1/230/50
RG5D	1/230/50



▶ **PRODUCT SPECIFICATION**

Burner:

Completely automatic monobloc light oil burners, with two stage operation fitted with:

- Fan with forward inclined blades
- Cover lined with sound-proofing material
- Air damper completely closed in stand by
- Air damper, with 1st and 2nd stage adjustment (2nd stage adjustment without removing the casing)
- Single phase electric motor 230 V, 50 Hz
- Combustion head fitted with:
 - stainless steel head cone, resistant to high temperatures
 - ignition electrodes
 - flame stability disk
- Geared pump for fuel supply, fitted with:
 - filter
 - pressure regulator
 - attachments for fitting a pressure gauge and vacuum meter
 - internal by-pass for preparing for single-pipe installations
- Fuel feed solenoid valve incorporated in the pump
- Photocell for flame detection
- Electronic flame control equipment
- Light oil nozzle
- IP 40 protection level
- PTC fuel pre-heater (optional).

Approval:

- EN 267 standard

Conforming to:

- Directive 89/336/EEC (electromagnetic compatibility)
- Directive 73/23/EEC (low voltage)
- Directive 98/37/EEC (machinery)
- Directive 92/42/EEC (efficiency).

Standard equipment:

- Two flexible pipes for connection to the light oil supply line
- Two nipples for connection to the pump
- Flange, screws and nuts for fixing
- Thermal screen
- 7-pin plug
- 4-pin plug
- Instruction handbook for installation, use and maintenance
- Spare parts catalogue.

Available accessories to be ordered separately:

- Extended head kit
- Spacer kit
- Control box 550 SMD and sensor flame
- Tester.



RIELLO S.p.A. - Via degli Alpini, 1 - 37045 LEGNAGO (VR) Italy
Tel. ++39.0442630111 - Fax ++39.044221980

Internet: <http://www.rielloburners.com> - E-mail: rburners@rielloburners.com

Since the Company is constantly engaged in the production improvement, the aesthetic and dimensional features, the technical data, the equipment and the accessories can be changed.
This document contains confidential and proprietary information of RIELLO S.p.A.
Unless authorised, this information shall not be divulged, nor duplicated in whole or in part.

