

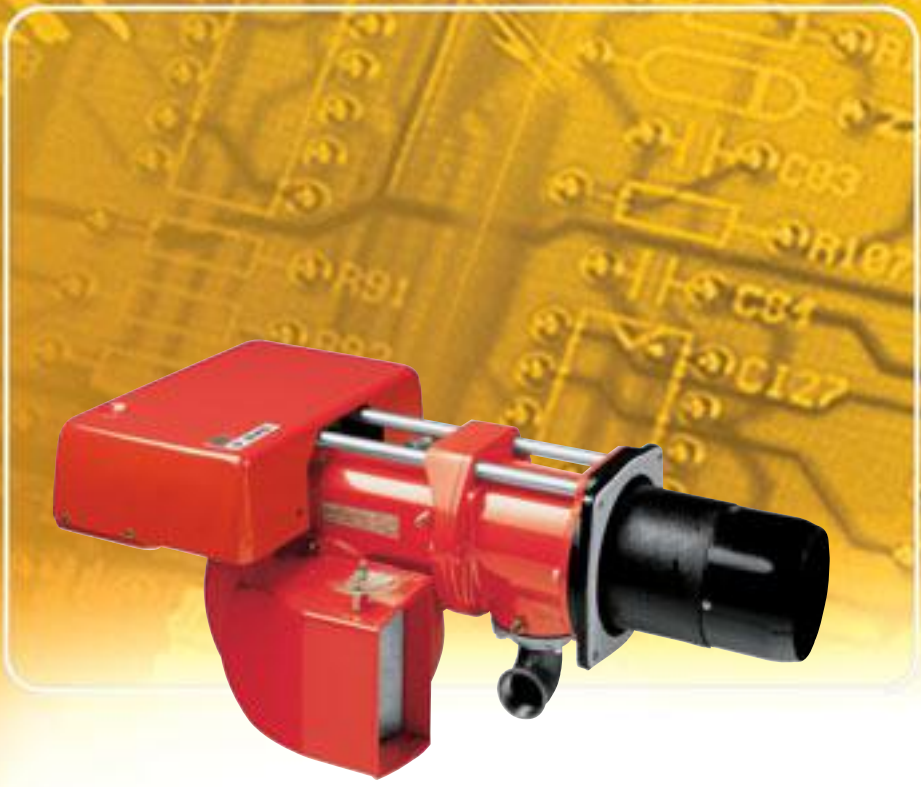

ONE STAGE GAS BURNERS

▶ GAS SERIES	▶ GAS 3	▶ GAS 4	▶ GAS 5	▶ GAS 6
	130 ÷ 350 kW	185 ÷ 465 kW	325 ÷ 660 kW	525 ÷ 1050 kW



The GAS series of burners cover a firing range from 130 to 1050 kW. Operation is "one stage"; the combustion head, that can be set on the basis of required output, allows optimal performance ensuring good combustion and reducing fuel consumption.

The GAS series are extremely reliable burners, featured by a simple use and an operation without particular maintenance intervention.

Simplified maintenance is achieved by the slide bar system, which allows easy access to all of the essential components of the combustion head. All electrical components are easily accessible only by dismounting a protection panel, thus guaranteeing a quick and simple intervention on components.

TECHNICAL DATA

Model		▼ GAS 3	▼ GAS 4	▼ GAS 5	▼ GAS 6
Burner operation mode		One stage			
Modulation ratio at max. output		--			
Servomotor	type	--			
	run time	s			
Heat output	kW	130÷350	185÷465	325÷660	525÷1050
	Mcal/h	112÷301	160÷400	280÷570	450÷900
Working temperature		°C min./max. 0/40			
Fuel / air data	Net calorific value G20 gas	kWh/Nm ³ 10			
	G20 gas density	kg/Nm ³ 0,71			
	G20 gas delivery	13÷35	18,5÷46,5	32,5÷66	52,5÷105
	Net calorific value G25 gas	kWh/Nm ³ 8,6			
	G25 gas density	kg/Nm ³ 0,78			
	G25 gas delivery	15÷41	22÷54	38÷77	61÷122
	Net calorific value LPG gas	kWh/Nm ³ 25,8			
	LPG gas density	kg/Nm ³ 2,02			
	LPG gas delivery	5,8÷14	7÷18	13÷26	20÷41
	Fan	type Centrifugal with forward curve blades			
Air temperature	Max. °C 60				
Electrical data	Electrical supply	Ph/Hz/V 1/50/230~(±10%)		3N/50/400~(±10%) △ 3/50/230~(±10%) △	
	Auxiliary electrical supply	Ph/Hz/V 1/50/230 ~ (±10%)			
	Control box	type RMG			
	Total electrical power	0,4	0,54	0,85	1,7
	Auxiliary electrical power	0,15	0,17	0,1	0,2
	Protection level	IP 40			
	Motor electrical power	0,25	0,37	0,75	1,5
	Rated motor current	1,8	2,9	2,85÷1,65	5,9÷3,4
	Motor start up current	4,8	9,5	10÷6	22,5÷13
	Motor protection level	IP 54			
Ignition transformer	type				
	V1 - V2	230 V - 1x8 kV			
	I1 - I2	1,8 A - 30 mA			
Operation		Intermittent (at least one stop every 24 h)			
Approval Emissions	Sound pressure	75	78	83	84
	Sound power	W --			
	CO emission	mg/kWh < 100			
	NOx emission	mg/kWh < 170			
Directive		73/23 - 89/336 - 90/396 - 92/42 EEC			
Conforming to		EN 676			
Certification		CE 0085AQ0707	--		

Reference conditions:

Temperature: 20°C

Pressure: 1013,5 mbar

Altitude: 100 m a.s.l.

Noise measured at a distance of 1 meter.

Since the Company is constantly engaged in the production improvement, the aesthetic and dimensional features, the technical data, the equipment and the accessories can be changed.

This document contains confidential and proprietary information of RIELLO S.p.A. Unless authorised, this information shall not be divulged, nor duplicated in whole or in part.



FIRING RATES

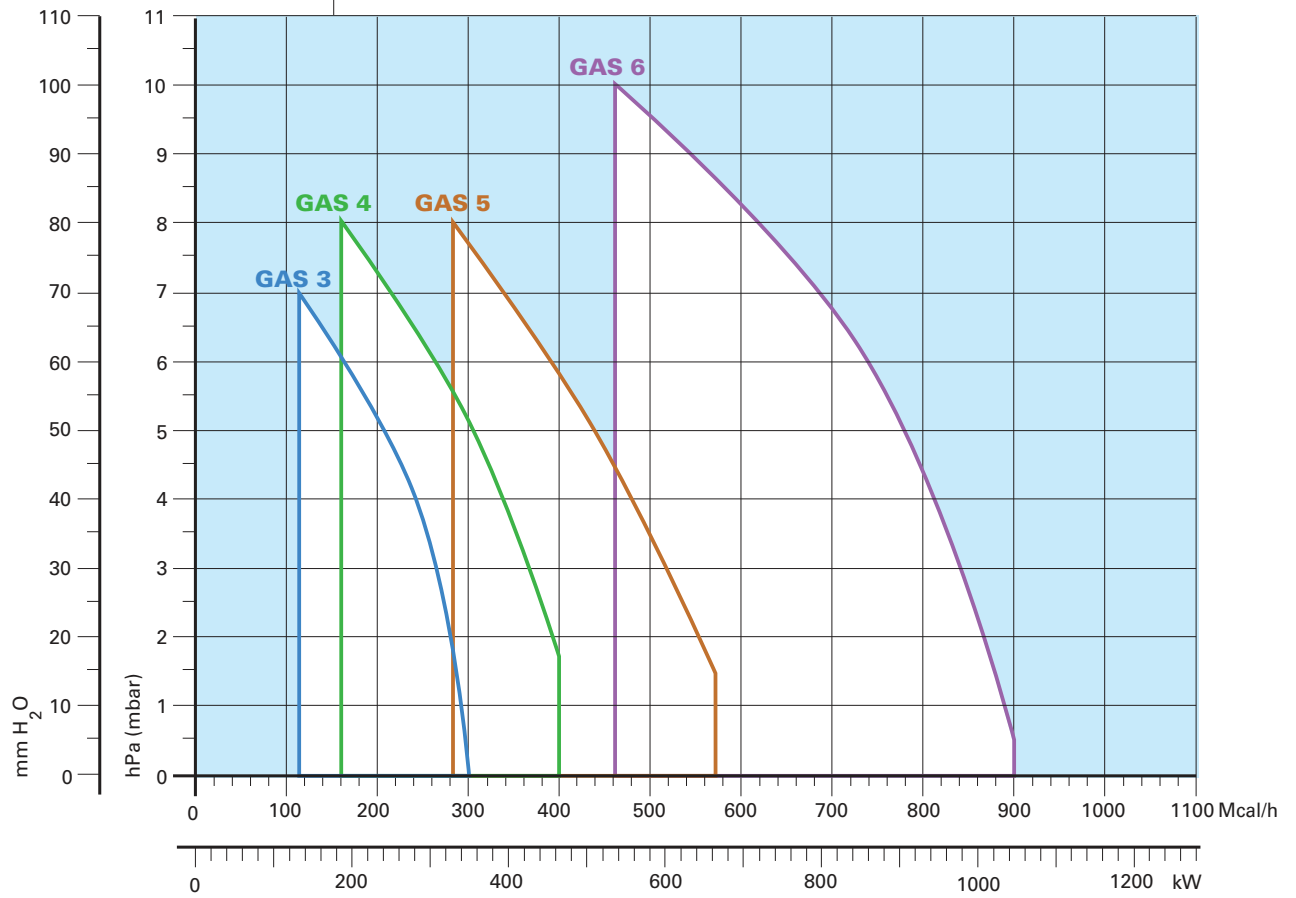

Useful working field for choosing the burner

Test conditions conforming to EN 676:

Temperature: 20°C
Pressure: 1013,5 mbar
Altitude: 100 m a.s.l.



FUEL SUPPLY

▶ GASTRAIN

Fuel can be supplied either from the right or left hand sides.

The gas train can be selected to best fit system requirements depending on the fuel output and pressure in the supply line. The gas train can be "Multibloc" type (containing the main components in a single unit) or "Composed" type (assembly of the single components).

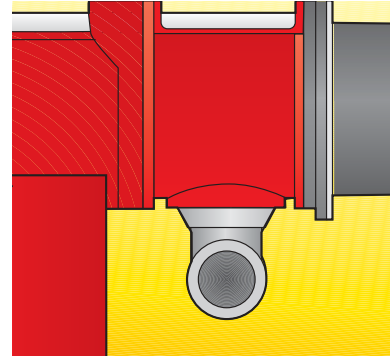

Example of the gas train connection flange of GAS burners.

MULTIBLOC gas train without seal control

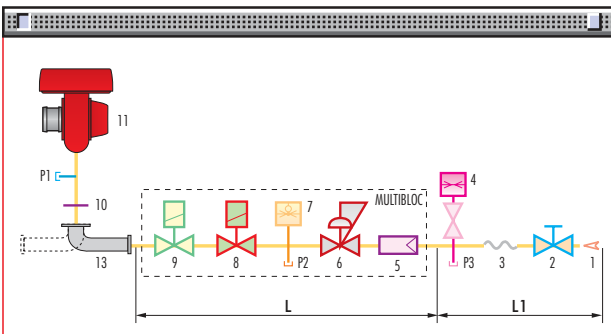

1	Gas input pipework
2	Manual valve
3	Anti-vibration joint
4	Pressure gauge with pushbutton cock
5	Filter
6	Pressure regulator (vertical)
7	Minimum gas pressure switch
8	VS safety solenoid (vertical)
9	VR regulation solenoid (vertical) Two settings: - firing output (rapid opening) - maximum output (slow opening)
10	Gasket and flange supplied with the burner
11	Burner
12	Seal control mechanism for valves 8-9. According to standard EN 676, the seal control is compulsory for burners with maximum output above 1200 kW
13	Gas train-burner adapter
P1	Combustion head pressure
P2	Pressure downstream from the regulator
P3	Pressure upstream from the filter
L	Gas train supplied separately, with the code given in the table
L1	Installer's responsibility

MULTIBLOC gas train with seal control

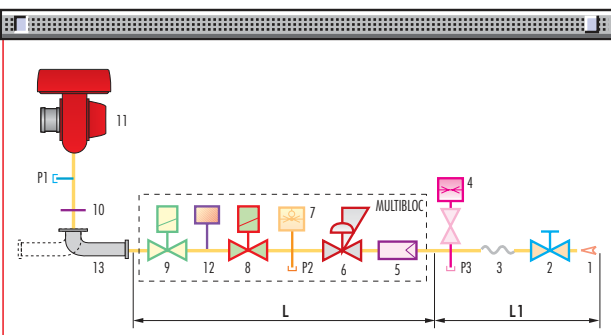

COMPOSED gas train without seal control

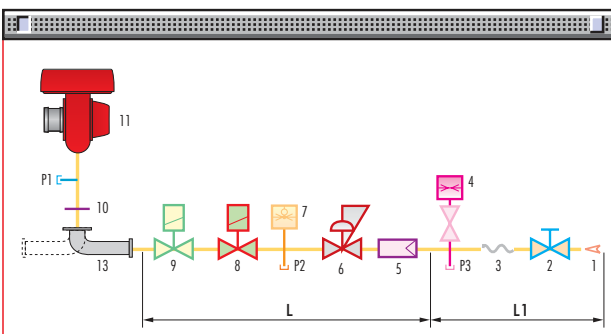

COMPOSED gas train with seal control

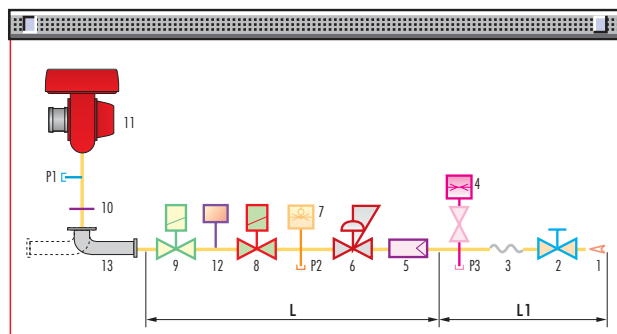

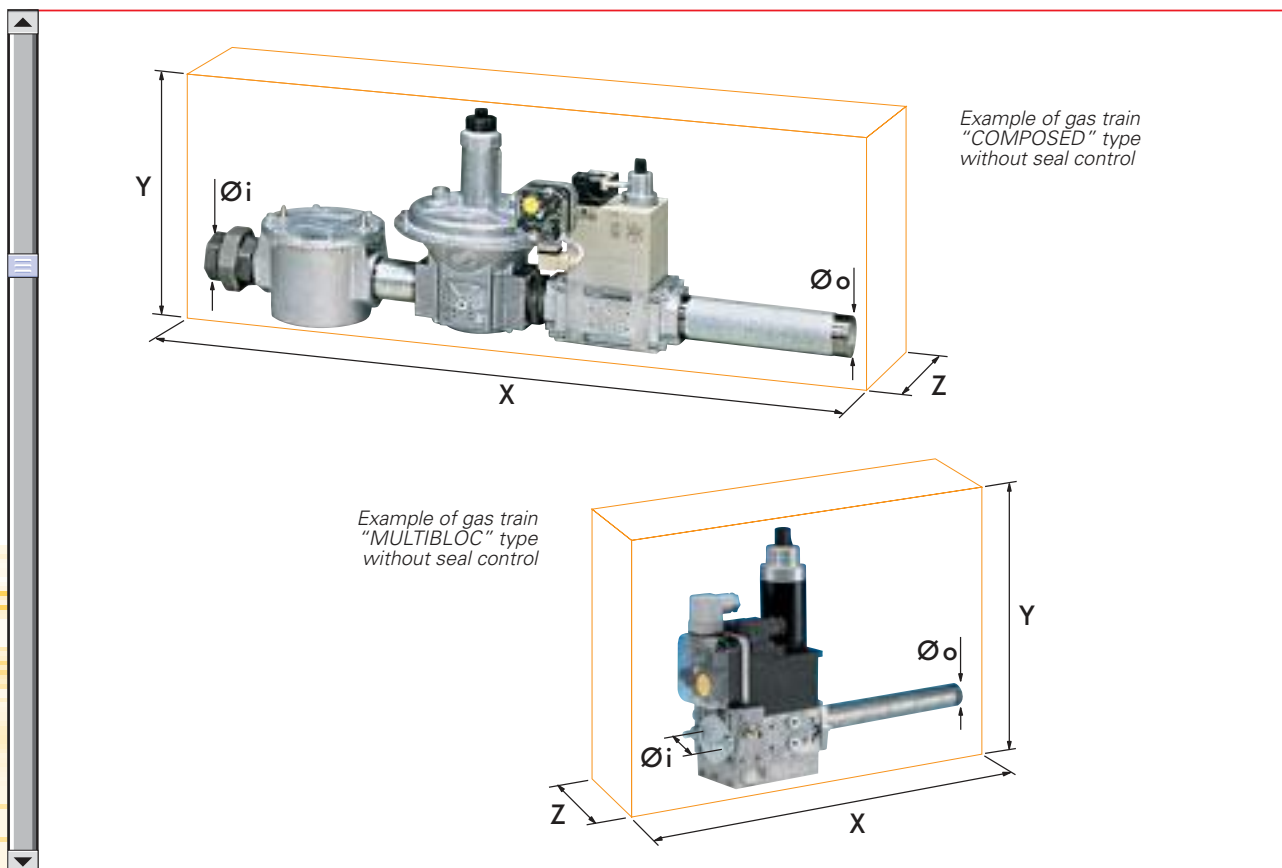

Gas trains are approved by standard EN 676 together with the burner.

The overall dimensions of the gas train depends on how they are constructed. The following table shows the maximum dimensions of the gas trains that can be fitted to the burners of GAS series, intake and outlet diameters and seal control if fitted.

Please note that the seal control can be installed as an accessory, if not already installed on the gas train.

The maximum gas pressure of gas train "Multibloc" type is 300 mbar, and that one of gas train "Composed" type is 500 mbar.

	Name	Code	Ø i	Ø o	X mm	Y mm	Z mm	Seal Control
MULTIBLOC GAS TRAINS	MBZRDLE 407	3970556	3/4"	3/4"	371	256	120	-
	MBZRDLE 410	3970557	1"	3/4"	405	315	145	-
	MBZRDLE 412	3970152	1"1/4	1"1/2	433	315	145	-
	MBZRDLE 415	3970183	1"1/2	1"1/2	523	350	100	-
	MBZRDLE 420	3970184	2"	2"	523	410	100	-
	MBZRDLE 420 CT	3970185	2"	2"	523	410	227	Incorporated
COMPOSED GAS TRAINS	CB 40/2	3970153	1"1/2	1"1/2	1013	345	195	-
	CB 50/2	3970154	2"	2"	1150	350	250	-
	CB 50/2 CT	3970166	2"	2"	1150	350	320	Incorporated
	CBF 65/2	3970155	DN 65	DN 65	1166	472	285	-
	CBF 65/2 CT	3970167	DN 65	DN 65	1166	472	390	Incorporated



PRESSURE DROP DIAGRAM

The diagrams indicate the minimum pressure drop of the burners with the various gas trains that can be matched with them; at the value of these pressure drop add the combustion chamber pressure.

The value thus calculated represents the minimum required input pressure to the gas train.

NATURAL GAS

LPG

GAS 3

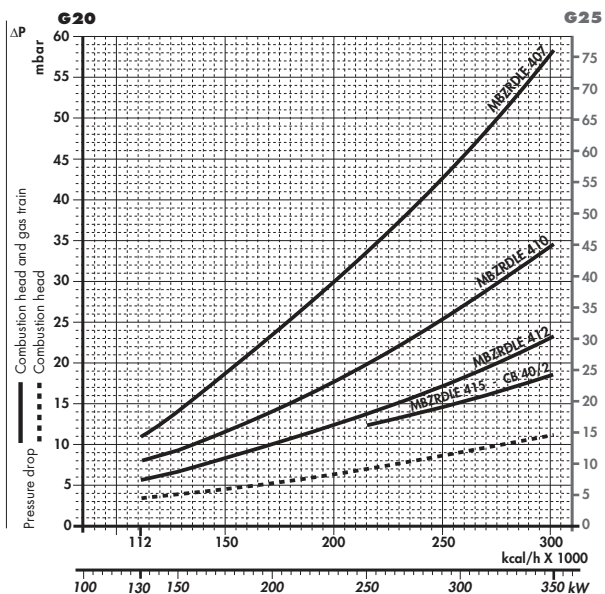

GAS 3

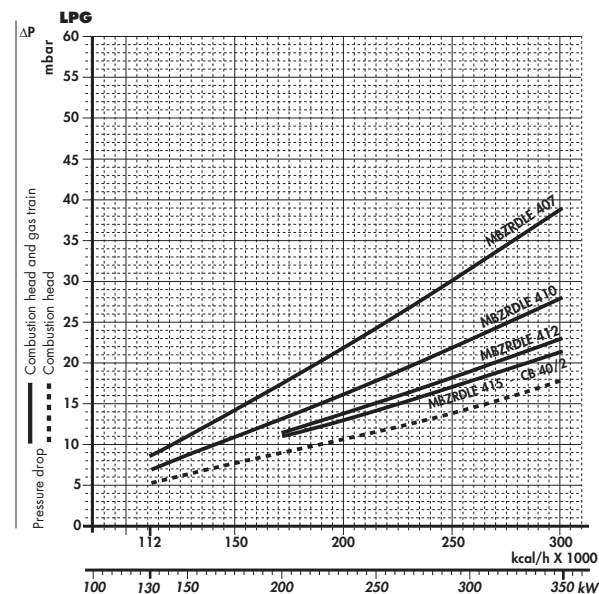

Gas train	Code	Adapter	Seal Control
MBZRDLE 407	3970556	3000824	Accessory
MBZRDLE 410	3970557	3000824	Accessory
MBZRDLE 412	3970152	-	Accessory
MBZRDLE 415	3970183	-	Accessory
CB 40/2	3970153	-	Accessory

GAS 4

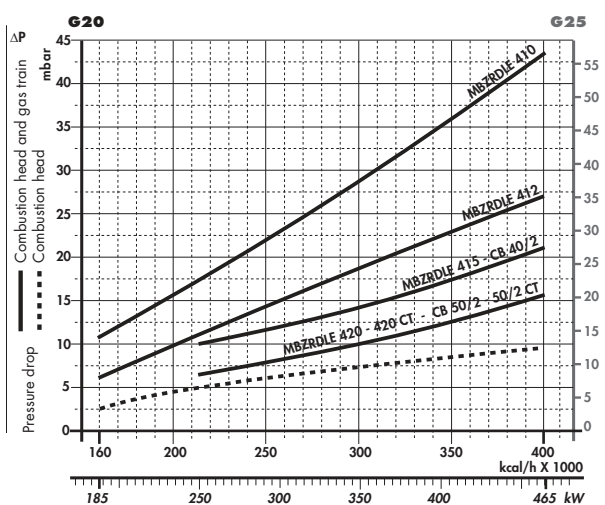

GAS 4

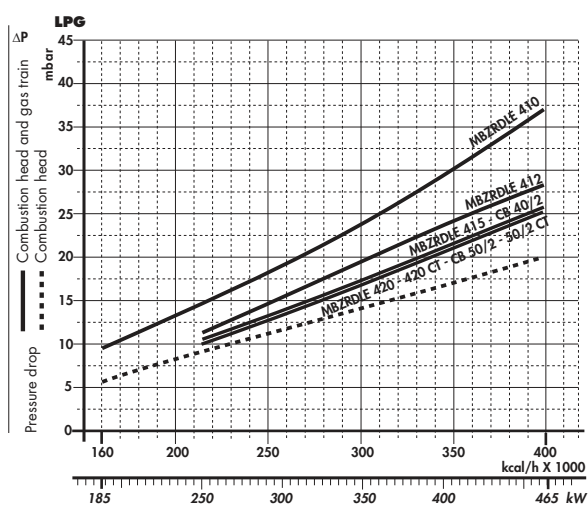

Gas train	Code	Adapter	Seal Control
MBZRDLE 410	3970557	3000824	Accessory
MBZRDLE 412	3970152	-	Accessory
CB 40/2	3970153	-	Accessory
MBZRDLE 415	3970183	-	Accessory

Gas train	Code	Adapter	Seal Control
CB 50/2	3970154	3000822	Accessory
CB 50/2 CT	3970166	3000822	Incorporated
MBZRDLE 420	3970184	3000822	Accessory
MBZRDLE 420 CT	3970185	3000822	Incorporated



NATURAL GAS

LPG

GAS 5

GAS 5

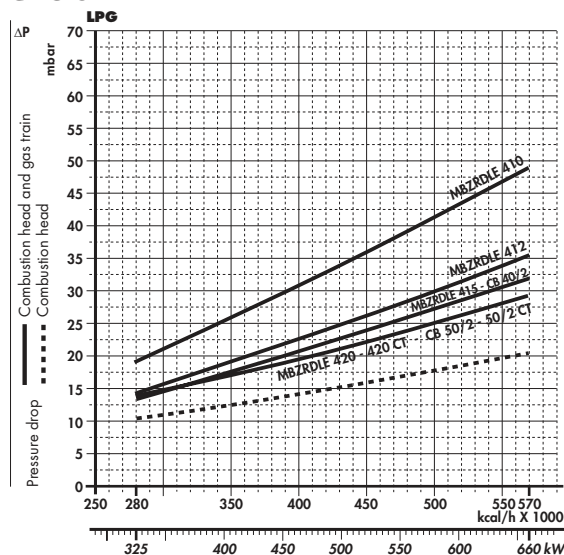
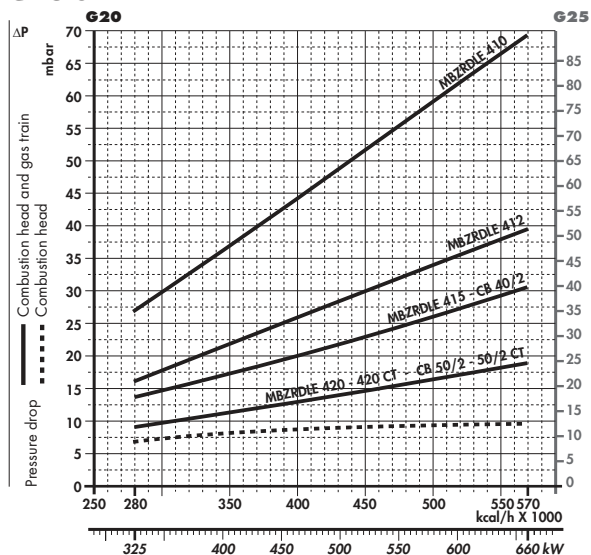

Gas train	Code	Adapter	Seal Control
MBZRDL E 410	3970557	3000824	Accessory
MBZRDL E 412	3970152	-	Accessory
CB 40/2	3970153	-	Accessory
MBZRDL E 415	3970183	-	Accessory

Gas train	Code	Adapter	Seal Control
CB 50/2	3970154	3000822	Accessory
CB 50/2 CT	3970166	3000822	Incorporated
MBZRDL E 420	3970184	3000822	Accessory
MBZRDL E 420 CT	3970185	3000822	Incorporated

GAS 6

GAS 6

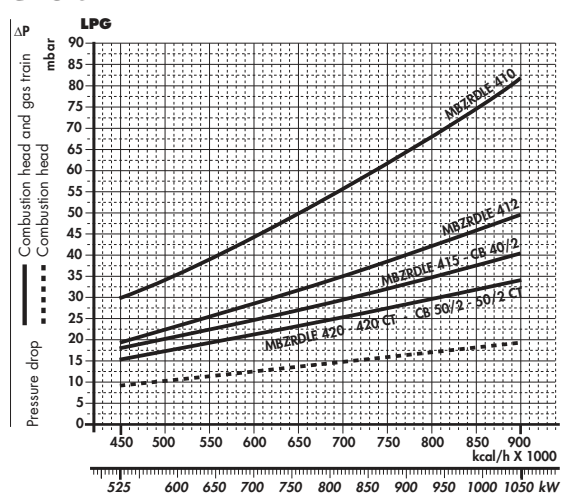
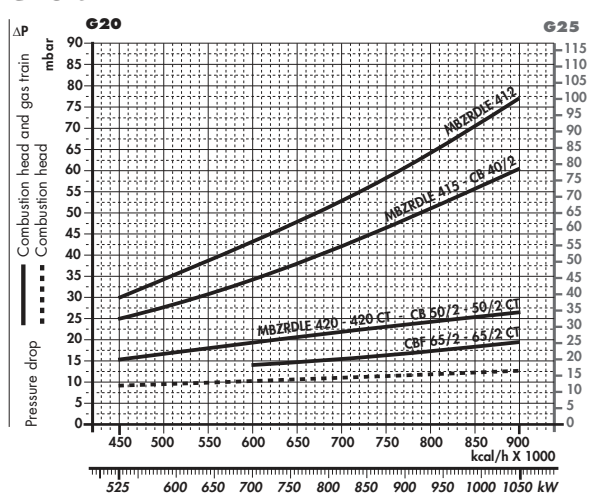

Gas train	Code	Adapter	Seal Control
MBZRDL E 410	3970557	3000824 3000843	Accessory
MBZRDL E 412	3970152	3000843	Accessory
CB 40/2	3970153	3000843	Accessory
MBZRDL E 415	3970183	-	Accessory
CB 50/2	3970154	-	Accessory

Gas train	Code	Adapter	Seal Control
CB 50/2 CT	3970166	-	Incorporated
MBZRDL E 420	3970184	3000822	Accessory
MBZRDL E 420 CT	3970185	3000822	Incorporated
CBF 65/2	3970155	3000825	Accessory
CBF 65/2 CT	3970167	3000825	Incorporated

note Please contact the Riello Burner Technical Office for different pressure levels from those above indicated and refer to the technical manual for the correct choice of the spring.



SELECTING THE FUEL SUPPLY LINES

The following diagram enables pressure drop in a pre-existing gas line to be calculated and to select the correct gas train.

The diagram can also be used to select a new gas line when fuel output and pipe length are known. The pipe diameter is selected on the basis of the desired pressure drop. The diagram uses methane gas as reference; if another gas is used, conversion coefficient and a simple formula (on the diagram) transform the gas output to a methane equivalent (refer to figure A). Please note that the gas train dimensions must take into account the back pressure of the combustion chamber during operations.

Control of the pressure drop in an existing gas line or selecting a new gas supply line.

The methane output equivalent is determined by the formula fig. A on the diagram and the conversion coefficient.

Once the equivalent output has been determined on the delivery scale (\dot{V}), shown at the top of the diagram, move vertically downwards until you cross the line that represents the pipe diameter; at this point, move horizontally to the left until you meet the line that represents the pipe length. Once this point is established you can verify, by moving vertically downwards, the pipe pressure drop on the bottom scale below (mbar).

By subtracting this value from the pressure measured on the gas meter, the correct pressure value will be found for the choice of gas train.

Example:

- gas used G25
- gas output 9.51 mc/h
- pressure at the gas meter 20 mbar
- gas line length 15 m
- conversion coefficient 0.62 (see figure A)

- equivalent methane output $\dot{V} = \left[\frac{9.51}{0.62} \right] = 15.34$ mc/h

- once the value of 15.34 has been identified on the output scale (\dot{V}), moving vertically downwards you cross the line that represents 1" 1/4 (the chosen diameter for the piping);
- from this point, move horizontally to the left until you meet the line that represents the length of 15 m of the piping;
- move vertically downwards to determine a value of 1.4 mbar in the pressure drop bottom scale;
- subtract the determined pressure drop from the meter pressure, the correct pressure level will be found for the choice of gas train;

- correct pressure = (20-1.4) = 18.6 mbar

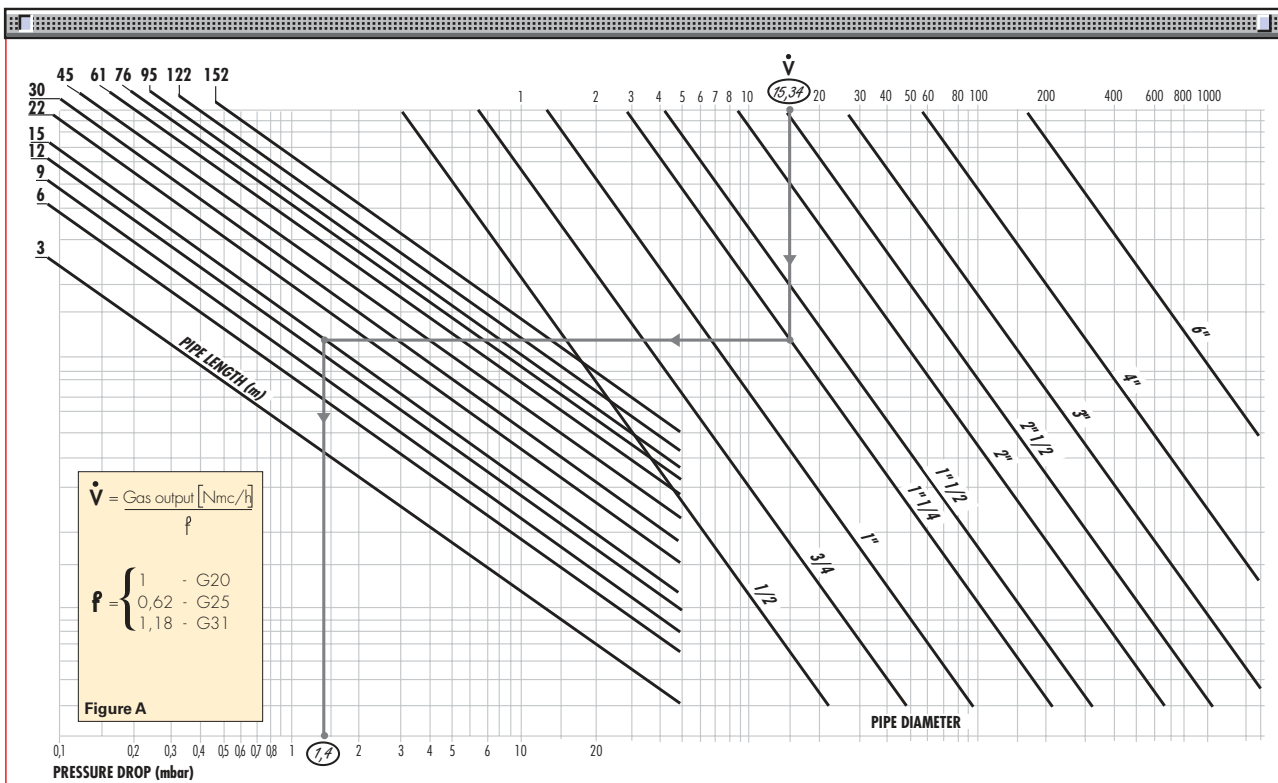

VENTILATION

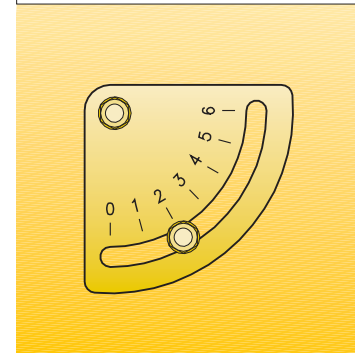

The ventilation circuit produces low noise levels with high performance pressure and air output, in spite of the compact dimensions.

The air damper is easy to set; when fitted, it makes no difference to air delivery.

Example of fan air gate valve indexed selector of GAS burner



COMBUSTION HEAD

Different combustion head length can be selected for the various models of GAS series of burners.

The choice depends on the thickness of the front panel and type of boiler. Correct head penetration into the combustion chamber depends on the type of heat generator.

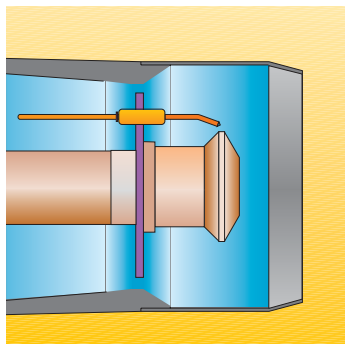

Example of a GAS burner combustion head

These burners are equipped with adjustable combustion head.

This enables optimum combustion performance throughout the working field, ensuring peak combustion efficiency thus saving on fuel consumption.

The following diagram shows the flame dimensions in relation to the burner output. The lengths and diameter shown in the diagram below should be employed for a preliminary check: if combustion chamber dimensions are different from the values in the diagram, further tests need to be done.



Flame dimensions

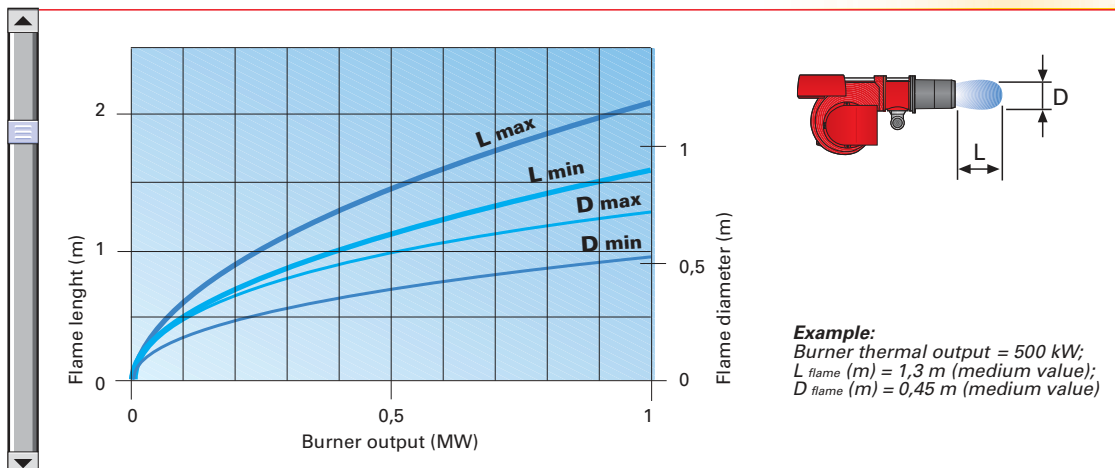



ADJUSTMENT

► BURNER OPERATION MODE

The burner of GAS series is one stage working.

On "one stage" operation, the burner adjusts output to the requested level, by varying between on-off phases (see picture A).

One stage operation

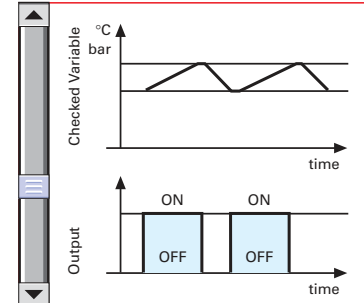

Picture A

All GAS series burners are fitted with a new microprocessor control panel for the supervision during intermittent operation.

For helping the commissioning and maintenance work, there are two main elements:



The lock-out reset button is the central **operating element** for resetting the burner control and for activating / deactivating the diagnostic functions.



The multi-color LED is the central **indication element** for visual diagnosis and interface diagnosis.

Both elements are located under the transparent cover of lock-out reset button, as showed below.

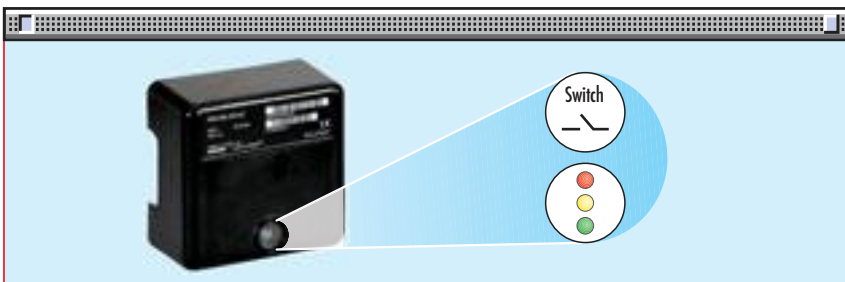

There are two diagnostic choices, for indication of operation and diagnosis of fault cause:

- visual diagnosis :

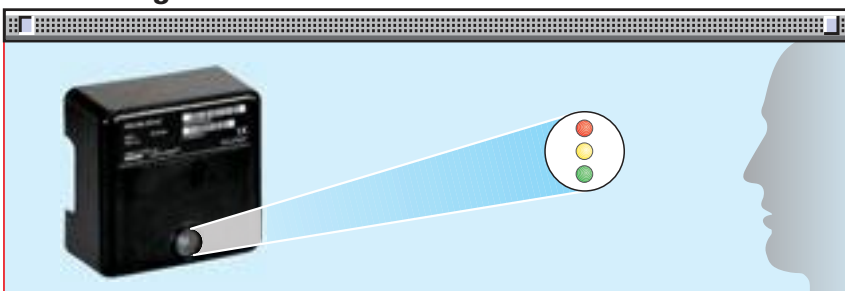

- interface diagnosis :

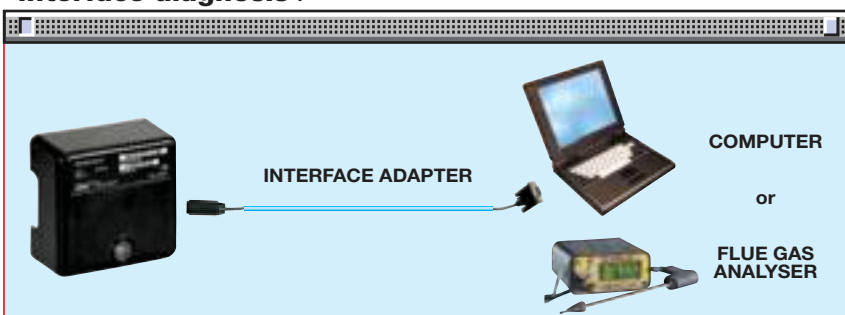

by the interface adapter and a PC with dedicated software or by a predisposed flue gas analyzer (see paragraph accessories).



Indication of operation :

In normal operation, the various status are indicated in the form of colour codes according to the table below.

The interface diagnosis (with adapter) can be activated by pressing the lock-out button for > 3 seconds.

Color code table	
Operation statuses	Color code table
Stand-by	○ ○ ○ ○ ○ ○ ○ ○
Pre-purging	☀ ☀ ☀ ☀ ☀ ☀ ☀ ☀
Ignition phase	☀ ○ ○ ○ ☀ ○ ○ ○
Flame OK	☀ ☀ ☀ ☀ ☀ ☀ ☀ ☀
Poor flame	☀ ○ ○ ○ ☀ ○ ○ ○
Undervoltage, built-in fuse	☀ ☀ ☀ ☀ ☀ ☀ ☀ ☀
Fault, alarm	☀ ☀ ☀ ☀ ☀ ☀ ☀ ☀
Extraneous light	☀ ☀ ☀ ☀ ☀ ☀ ☀ ☀

○ LED off

Diagnosis of fault causes :

After lock-out has occurred, the red signal lamp is steady on. In this status, the visual fault diagnosis according to the error code table can be activated by pressing the lock-out reset button for > 3 seconds. The interface diagnosis (with adapter) can be activated by pressing again the lock-out button for > 3 seconds.

The blinkers of red LED are a signal with this sequence :

(e.g. signal with n° 3 blinks – faulty air pressure monitor)

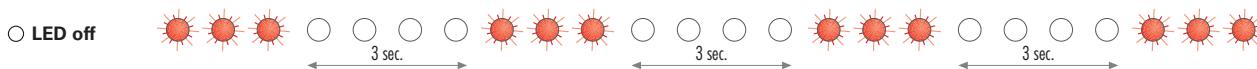

Error code table	
Possible cause of fault	Blink code
No establishment of flame at the end of safety time : - faulty or soiled fuel valves - faulty or soiled flame detector - poor adjustment of burner, no fuel - faulty ignition equipment	☀ ☀
Faulty air pressure monitor	☀ ☀ ☀
Simulation of flame on burner start up	☀ ☀ ☀ ☀
Loss of flame during operation : - faulty or soiled fuel valves - faulty or soiled flame detector - poor adjustment of burner	☀ ☀ ☀ ☀ ☀ ☀ ☀ ☀
Wiring error or internal fault	☀ ☀ ☀ ☀ ☀ ☀ ☀ ☀ ☀ ☀

START UP CYCLE

GAS 3 - 4 - 5 - 6

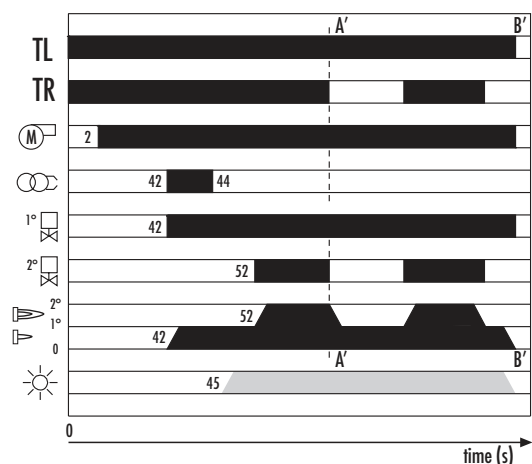

- 0 s The burner begins the firing cycle.
- 2 s The motor starts: pre-purge phase.
- 42 s Ignition electrode sparks; the safety valve and the firing delivery valve opens.
- 45 s Lock out signal is activated if flame is not revealed by the flame detector.
- 52 s The working valve opens; the start up cycle is concluded.





WIRING DIAGRAMS

Electrical connections must be made by qualified and skilled personnel, according to the local norms.

ONE STAGE OPERATION - Single-phase power supply

GAS 3 - 4
Without seal control

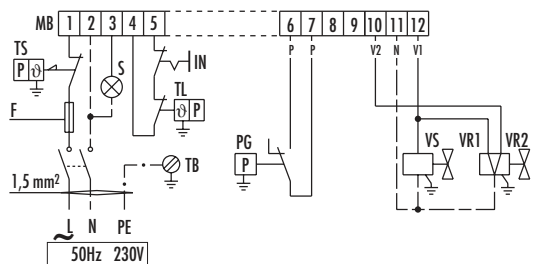

- MB** - Burner terminal board
- TS** - Safety thermostat
- TL** - Threshold thermostat
- PG** - Minimum gas pressure switch
- S** - External lock-out signal
- TB** - Burner ground (earth) connection
- IN** - Manual switch
- F** - Fuse (see table A)
- VR1** - 1st adjustment valve
- VR2** - 2nd adjustment valve
- VS** - Safety valve

GAS 3 - 4
With seal control

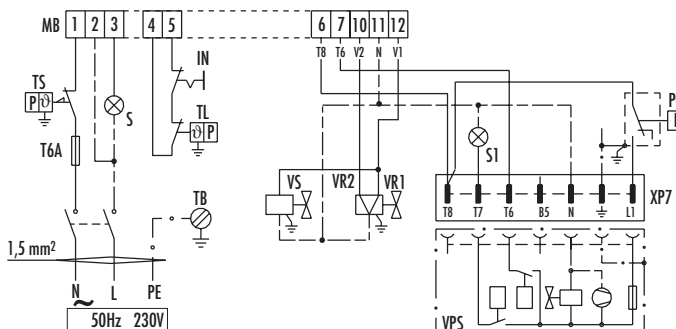

- MB** - Burner terminal board
- TS** - Safety thermostat
- TL** - Threshold thermostat
- PG** - Minimum gas pressure switch
- S** - External lock-out signal
- S1** - External lock-out signal on the seal control
- TB** - Burner ground (earth) connection
- T6A** - 6A fuse
- VR1** - 1st adjustment valve
- VR2** - 2nd adjustment valve
- VS** - Safety valve
- VPS** - Seal control
- XP** - Seal control plug

- IN** - Manual switch

ONE STAGE OPERATION - Triple-phase power supply

GAS 5 - 6
Without seal control

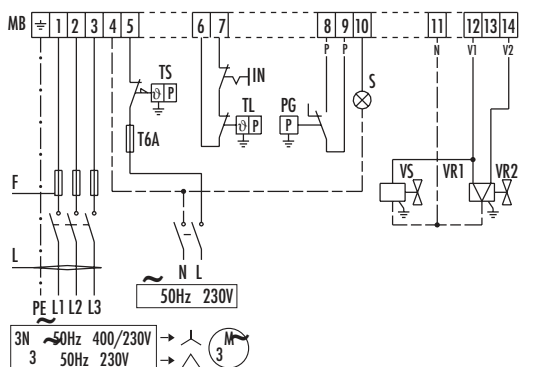

- MB** - Burner terminal board
- TS** - Safety thermostat
- TL** - Threshold thermostat
- PG** - Minimum gas pressure switch
- S** - External lock-out signal
- IN** - Manual switch
- T6A** - 6A fuse
- F** - Fuse (see table A)
- L** - Lead section (see table A)
- VR1** - 1st adjustment valve
- VR2** - 2nd adjustment valve
- VS** - Safety valve

GAS 5 - 6
With seal control

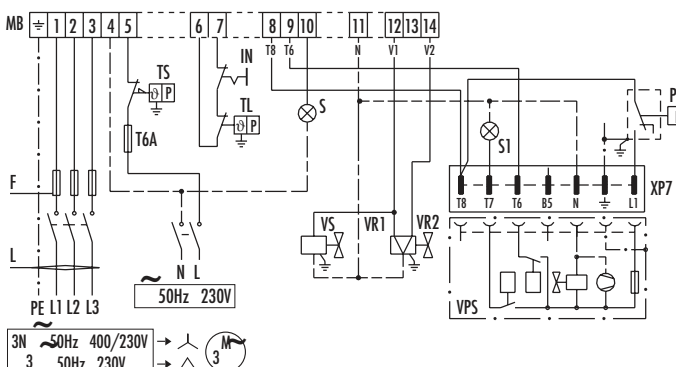

- MB** - Burner terminal board
- TS** - Safety thermostat
- TL** - Threshold thermostat
- PG** - Minimum gas pressure switch
- S** - External lock-out signal
- S1** - External lock-out signal on the seal control
- IN** - Manual switch
- T6A** - 6A fuse
- F** - Fuse (see table A)
- L** - Lead section (see table A)
- VR1** - 1st adjustment valve
- VR2** - 2nd adjustment valve
- VS** - Safety valve
- VPS** - Seal control
- XP** - Seal control plug

- T6A** - 6A fuse
- F** - Fuse (see table A)
- L** - Lead section (see table A)
- VR1** - 1st adjustment valve
- VR2** - 2nd adjustment valve
- VS** - Safety valve
- VPS** - Seal control
- XP** - Seal control plug

The following table shows the supply lead sections and the type of fuse to be used.

Model	▼ GAS 3		▼ GAS 4		▼ GAS 5		▼ GAS 6	
	230V	230V	230V	230V	230V	400V	230V	400V
F A	T6	T6	T6	T6	T6	T6	T16	T10
L mm ²	1,5	1,5	1,5	1,5	1,5	1,5	1,5	1,5

EMISSIONS

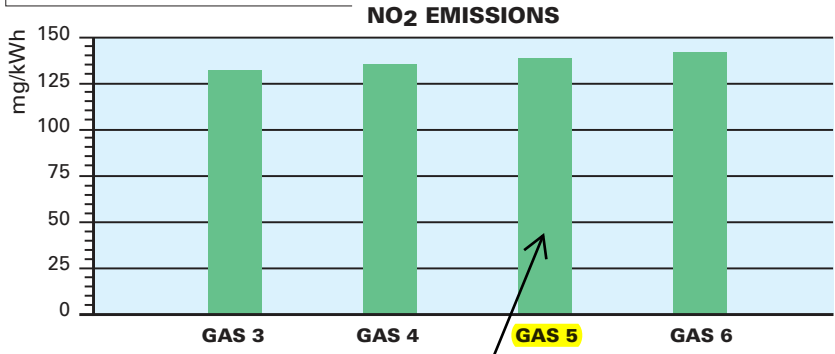

NO_x Emission ≤67 ppm

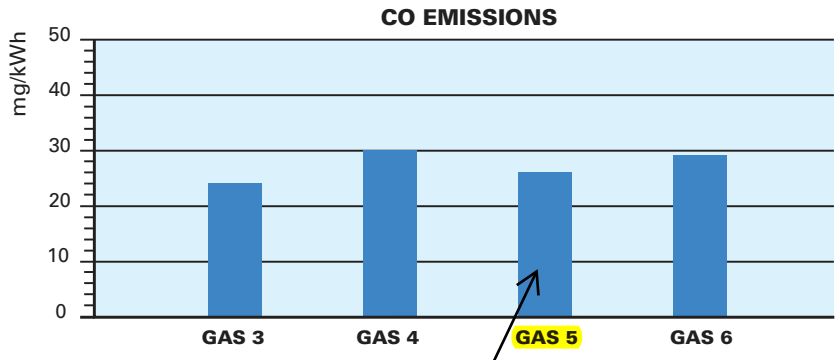

CO Emission ≤12.7 ppm

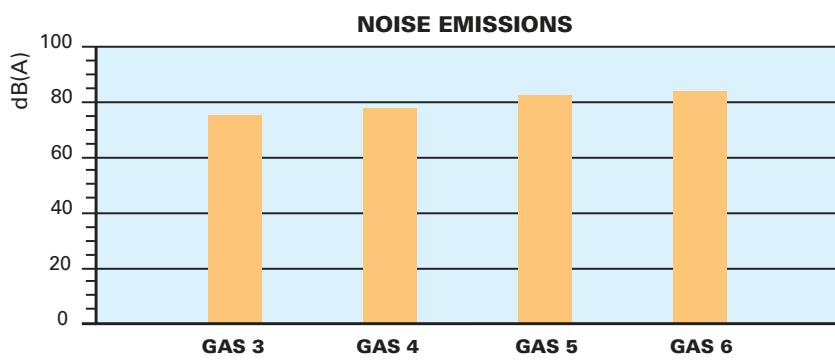

The emission data has been measured in the various models at maximum output, according to EN 676 standard.





OVERALL DIMENSIONS (mm)

BURNER

GAS 3 - 4 - 5 - 6

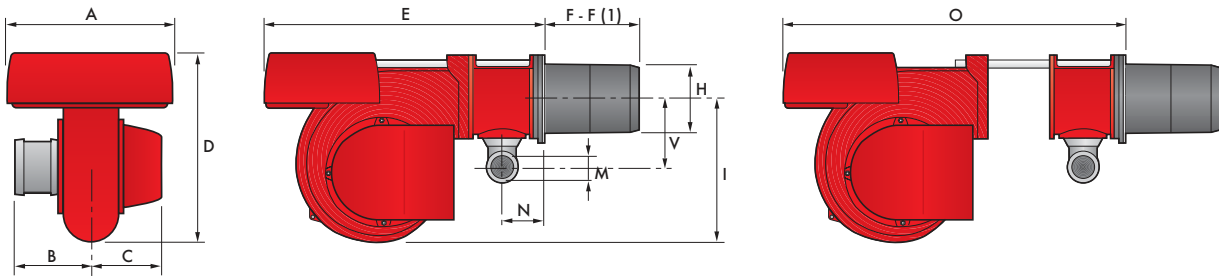

Model	A	B	C	D	E	F - F (1)	H	I	M	N	O	V
▶ GAS 3	410	205	205	397	610	185 - 320	140	292	1"1/2	97	775	165
▶ GAS 4	410	205	205	397	610	187 - 320	150	292	1"1/2	97	775	165
▶ GAS 5	431	226	205	437	645	207 - 365	155	332	1"1/2	97	810	165
▶ GAS 6	463	258	205	485	770	227 - 360	175	370	2"	131	966	195

(1) Length with extended combustion head

BURNER - BOILER MOUNTING FLANGE

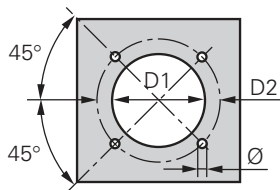

Model	D1	D2	Ø
▶ GAS 3	155	226	M10
▶ GAS 4	165	226	M10
▶ GAS 5	165	226	M10
▶ GAS 6	185	276	M12

PACKAGING

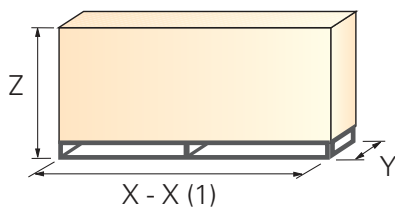

Model	X - X (1)	Y	Z	kg
▶ GAS 3	850	545	473	32
▶ GAS 4	850	545	473	38
▶ GAS 5	895	543	520	41
▶ GAS 6	1045	543	555	58

(1) Length with extended combustion head

INSTALLATION DESCRIPTION



Installation, start up and maintenance must be carried out by qualified and skilled personnel.
All operations must be performed in accordance with the technical handbook supplied with the burner.



BURNER SETTING

- ▶ All the burners have slide bars, for easier installation and maintenance.
- ▶ After drilling the boilerplate, using the supplied gasket as a template, dismantle the blast tube from the burner and fix it to the boiler.
- ▶ Adjust the combustion head.
- ▶ Fit the gas train, choosing this on the basis of the maximum output of the boiler and considering the enclosed diagrams.
- ▶ Refit the burner casing to the slide bars.
- ▶ Close the burner, sliding it up to the flange.

ELECTRICAL CONNECTIONS AND START UP

- ▶ Make the electrical connections to the boiler following the wiring diagrams included in the instruction handbook.
- ▶ Perform a first ignition calibration on the gas train.
- ▶ On start up, check:
 - Gas pressure at the combustion head (to max. and min. output)
 - Combustion quality, in terms of unburned substances and excess air.



BURNER ACCESSORIES

Extended head kit

“Standard head” burners can be transformed into “extended head” versions, by using the special kit. The KITS available for the various burners, giving the original and the extended lengths, are listed below.

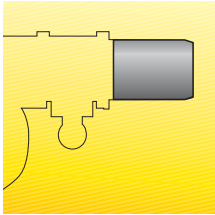

Extended head kit			
Burner	Standard head length (mm)	Extended head length (mm)	Kit code
GAS 3	185	320	3000605
GAS 4	187	320	3000606
GAS 5	207	365	3000607
GAS 6	227	360	3000608

Spacer kit

If burner head penetration into the combustion chamber needs reducing, varying thickness spacers are available, as given in the following table:



Spacer kit		
Burner	Spacer thickness S (mm)	Kit code
GAS 3 - 4 - 5 - 6	142	3000755

Continuous ventilation kit

If the burner requires continuous ventilation in the stages without flame, a special kit is available as given in the following table:



Continuous ventilation kit	
Burner	Kit code
GAS 3 - 4 - 5 - 6	3010030

Post-ventilation kit

To prolong ventilation for approximately 5 seconds after opening of thermostats chain, a special kit is available.

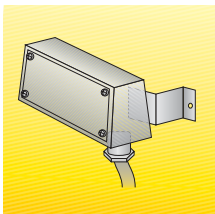

Post-ventilation kit	
Burner	Kit code
GAS 3 - 4 - 5 - 6	3010004



Sound proofing box

If noise emission needs reducing even further, sound-proofing boxes are available, as given in the following table:



Sound proofing box			
Burner	Box type	Average noise reduction [dB(A)] (*)	Box code
GAS 3 - 4 - 5 - 6	C1/3	10	3010403

(*) according to EN 15036-1 standard

LPG kit

For burning LPG gas, a special kit is available to be fitted to the combustion head on the burner, as given in the following table:

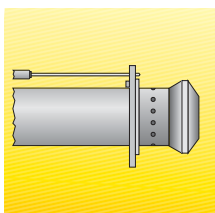

LPG kit		
Burner	Kit code for standard head	Kit code for extended head
GAS 3	3000657	3000807
GAS 4	3000658	3000808
GAS 5	3000659	3000809
GAS 6	3000753	3000810

Town Gas kit

For burning Town gas, a special kit is available to be fitted to the combustion head on the burner, as given in the following table:

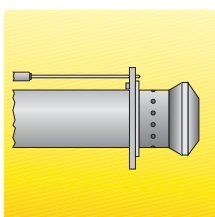

Town Gas kit		
Burner	Kit code for standard head (*)	Kit code for extended head (*)
GAS 3	3000742	-
GAS 4	3000754	-
GAS 5	3000759	-
GAS 6	3000768	-

(*) Without CE certification

PC interface kit

To connect the flame control panel to a personal computer or a predisposed flue gas analyzer for the transmission of operation, fault signals and detailed service information, an interface adapter with PC software are available.



PC interface kit	
Burner	Kit code
GAS 3 - 4 - 5 - 6	3002719



GAS TRAIN ACCESSORIES

Adapters

When the diameter of the gas train is different from the set diameter of the burners, an adapter must be fitted between the gas train and the burner. The following table lists the adapters for various burners.

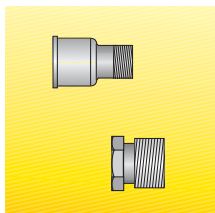

Adapters			
Burner	Gas train	Dimensions	Adapter code
GAS 3	MBZRDLE 407 - 410	3/4" 1" 1/2	3000824
GAS 4	MBZRDLE 410	3/4" 1" 1/2	3000824
	MBZRDLE 420 - CB 50/2	2" 1" 1/2	3000822
GAS 5	MBZRDLE 410	3/4" 1" 1/2	3000824
	MBZRDLE 420 - CB 50/2	2" 1" 1/2	3000822
GAS 6	MBZRDLE 410	3/4" 1" 1/2	3000824
		1" 1/2" 2"	3000843
	MBZRDLE 412 - 415 - CB 40/2	1" 1/2" 2"	3000843
	CBF 65/2	DN 65 2" 1/2" 1" 1/2" 2"	3000825

Stabiliser spring

Accessory springs are available to vary the pressure range of the gas train stabilisers. The following table shows these accessories with their application range.



Stabiliser springs		
Gas train	Spring	Code
CBF 65/2	Red from 25 to 55 mbar	3010133
CBF 65/2	Black from 60 to 110 mbar	3010135
CBF 65/2	Pink from 90 to 150 mbar	3090456

Please refer to the technical manual for the correct choice of spring.

Seal control kit

To test the valve seals on the gas train, a special "seal control kit" is available. The valve seal control device is compulsory (EN 676) on gas trains to burners with a maximum output over 1200 kW. The sealing control is type VPS 504.



Seal control kit		
Burner	Gas train	Kit code
GAS 3	MBZRDLE 407 - 410 - 412	3010123
	MBZRDLE 415 - CB 40/2	3010125
GAS 4	MBZRDLE 410 - 412	3010123
	MBZRDLE 415 - 420 - CB 40/2 - 50/2	3010125
GAS 5	MBZRDLE 410 - 412	3010123
	MBZRDLE 415 - 420 - CB 40/2 - 50/2	3010125
GAS 6	MBZRDLE 410 - 412	3010123
	MBZRDLE 415 - 420 - CB 40/2 - 50/2 - 65/2	3010125

SPECIFICATION



A specific index guides your choice of burner from the various models available in the GAS series. Below is a clear and detailed specification description of the product.



DESIGNATION OF SERIES

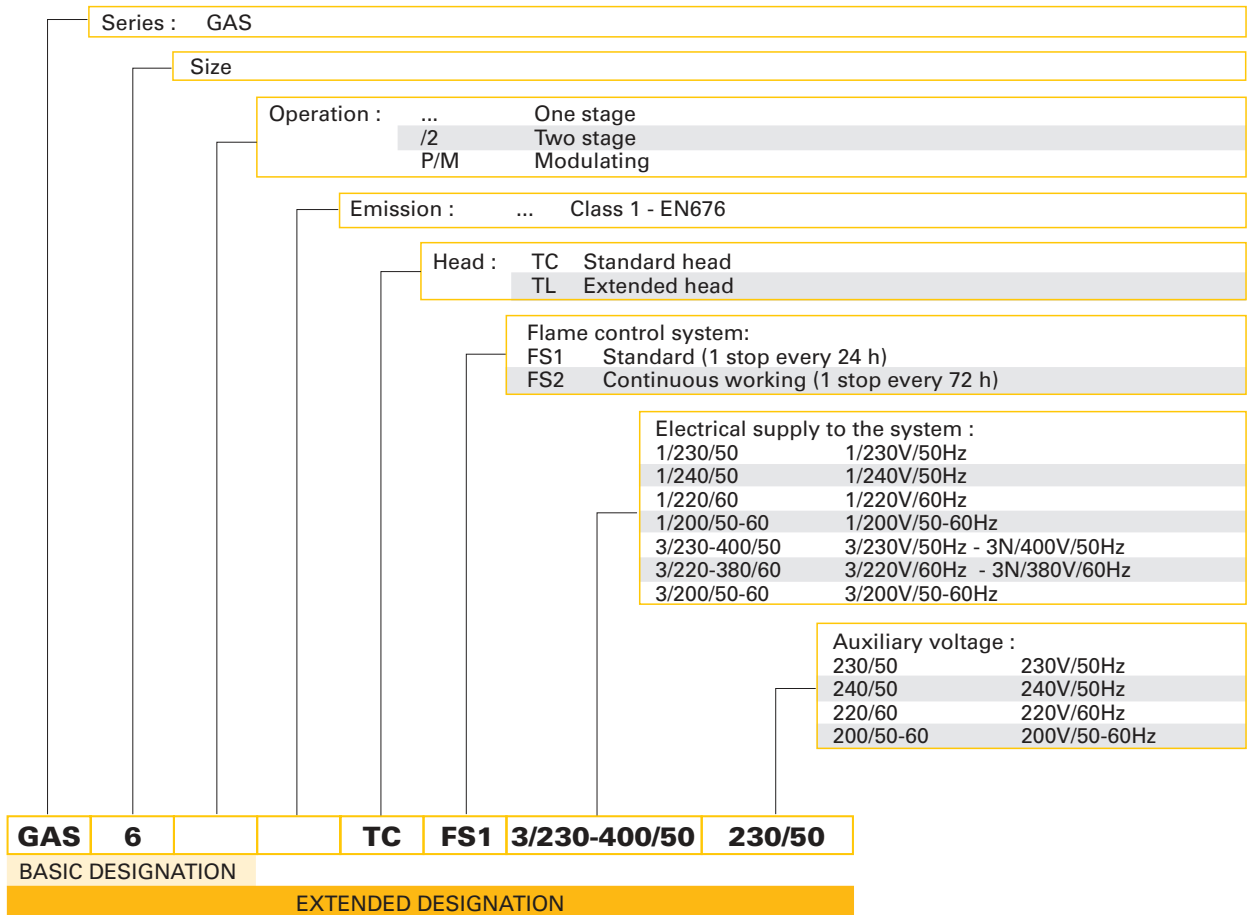

AVAILABLE BURNER MODELS

GAS 3	TC	FS1	1/200/50-60	200/50-60
GAS 3	TC	FS1	1/220/60	220/60
GAS 3	TC	FS1	1/230/50	230/50
GAS 3	TC	FS1	1/240/50	240/50
GAS 3	TL	FS1	1/240/50	240/50
GAS 4	TC	FS1	1/230/50	230/50
GAS 4	TC	FS1	3/200/50-60	200/50-60
GAS 4	TC	FS1	3/220-380/60	220/60

GAS 5	TC	FS1	3/200/50-60	200/50-60
GAS 5	TC	FS1	3/220-380/60	220/60
GAS 5	TC	FS1	3/230-400/50	230/50
GAS 6	TC	FS1	3/200/50-60	200/50-60
GAS 6	TC	FS1	3/220-380/60	220/60
GAS 6	TC	FS1	3/230-400/50	230/50

Other versions are available on request.

▶ PRODUCT SPECIFICATION

Burner:

Monoblock forced draught gas burner with one stage operation, fully automatic, made up of:

- Air suction circuit
- Fan with forward curve blades high performance concerning pressure and air delivery
- Air damper for air setting
- Starting motor at 2800 rpm
- Combustion head, that can be set on the basis of required output, fitted with:
 - stainless steel end cone, resistant to corrosion and high temperatures
 - ignition electrodes
 - ionisation probe
 - gas distributor
 - flame stability disk
- Minimum air pressure switch stops the burner in case of insufficient air quantity at the combustion head
- Microprocessor-based flame control panel with diagnostic functions
- Terminal strip for electrical connections
- Slide bars for easier installation and maintenance
- Protection filter against radio interference
- IP 40 electric protection level.

Gas train:

Fuel supply line, in the MULTIBLOC configuration (from a diameter of 3/4" until a diameter 2") or COMPOSED configuration (from a diameter of DN 40 until a diameter of DN 65), fitted with:

- Filter
- Stabiliser
- Minimum gas pressure switch
- Safety valve
- One stage or two stage working valve with ignition gas output regulator.

Conforming to:

- 89/336/EEC directive (electromagnetic compatibility)
- 73/23/EEC directive (low voltage)
- 92/42/EEC directive (performance)
- 90/396/EEC directive (gas)
- EN 676 (gas burners).

Standard equipment:

- 1 gas train gasket
- 1 flange gasket
- 4 screws for fixing the flange
- 1 thermal screen
- 4 screws for fixing the burner flange to the boiler
- Instruction handbook for installation, use and maintenance
- Spare parts catalogue.

Available accessories to be ordered separately:

- Extended head kit
- Spacer kit
- Continuous ventilation kit
- Post-ventilation kit
- Sound-proofing box
- LPG kit
- Town gas kit
- PC interface kit
- Gas train adapter
- Stabiliser spring
- Seal control kit.









RIELLO S.p.A. - Via Ing. Pilade Riello, 5 - 37045 Legnago (VR) Italy
Tel. ++39.0442630111 - Fax ++39.044221980

Internet: <http://www.rielloburners.com> - E-mail: info@rielloburners.com

Since the Company is constantly engaged in the production improvement, the aesthetic and dimensional features, the technical data, the equipment and the accessories can be changed.
This document contains confidential and proprietary information of RIELLO S.p.A.
Unless authorised, this information shall not be divulged, nor duplicated in whole or in part.

