

RLS 300÷800/E-EV MX SERIES

RLS/E-EV MX series burners are characterised by a modular monoblock structure that means all necessary components can be combined in a single unit thus making installation easier, faster and, above all, more flexible.

The series covers a firing range from 1250 to 8000 kW, and they have been designed for use in hot water boilers, overheated water boilers as well as steam boilers. Operation can be “two stage progressive” or alternatively “modulating” for both fuels, light oil and gas, with the installation of a PID logic regulator on the RLS/E series burners while RLS/EV series is fully “modulating”. The burner can, therefore, supply with precision the demanded power, guaranteeing a high efficiency system level and the stability setting, obtaining fuel consumption and operating costs reduction.

The innovative combustion head, adjustment system ensures perfect movement during modulation as well as reducing noise and pollutants.



RLS 300/E MX	600/1250 ÷ 3550 kW
RLS 400/E MX	800/1800 ÷ 4300 kW
RLS 500/E MX	1120/2500 ÷ 5050 kW
RLS 650/E MX	1430/3000 ÷ 6550 kW
RLS 800/E MX	1750/3500 ÷ 8000 kW
RLS 300/EV MX	600/1250 ÷ 3550 kW
RLS 400/EV MX	800/1800 ÷ 4300 kW
RLS 500/EV MX	1120/2500 ÷ 5050 kW
RLS 650/EV MX	1430/3000 ÷ 6550 kW
RLS 800/EV MX	1750/3500 ÷ 8000 kW

FIRING RATES

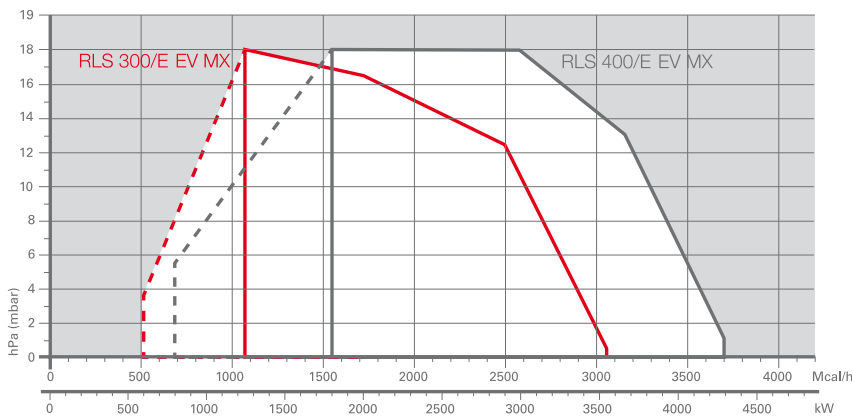

Useful working field for choosing the burner



Modulation range

Test conditions conforming to EN267-EN676
 Temperature: 20°C
 Pressure: 1013,5 mbar
 Altitude: 0 m a.s.l.

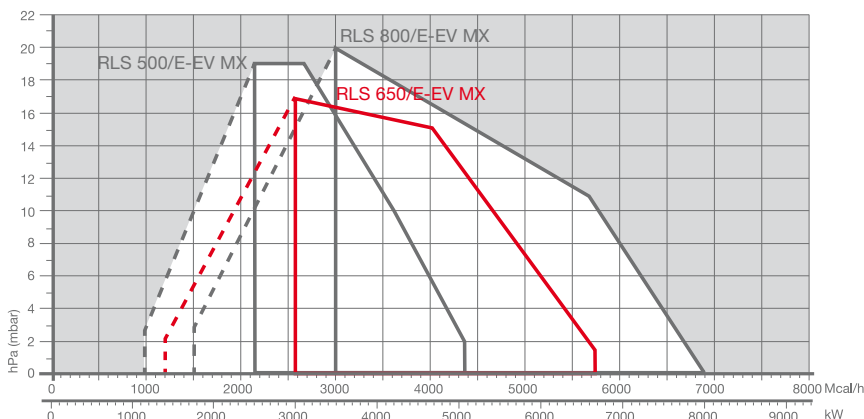

Low NOx Modulating Dual Fuel Burners

RLS 300-800/E-EV MX SERIES

Overall dimensions (mm)

BURNER

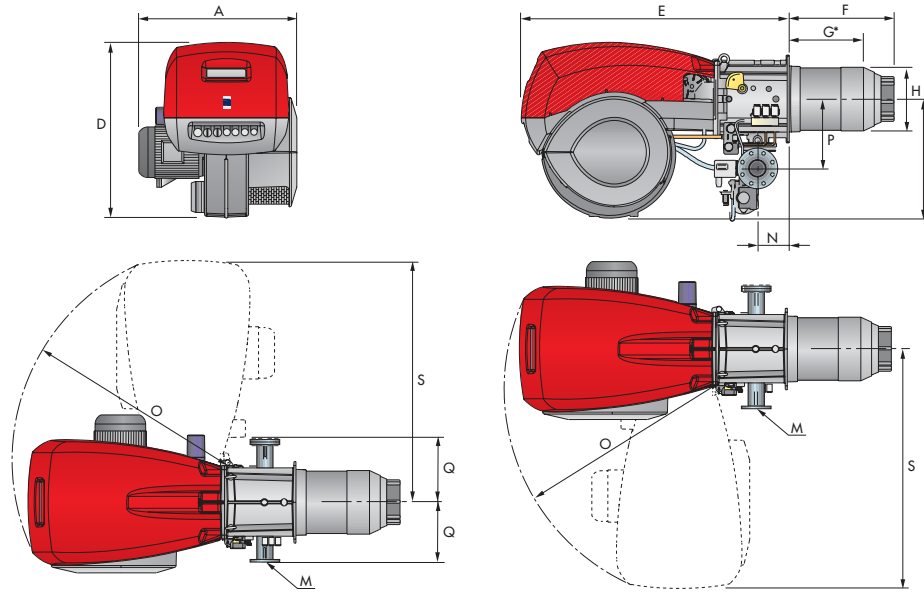

MODEL	A	D	E	F	G*	H	I	M	N	O	P	Q	S
▶ RLS 300/E-EV MX	720	890	1325	508	365	313	605	DN80	164	1055	342	320	1175
▶ RLS 400/E-EV MX	775	890	1325	508	365	313	605	DN80	164	1055	342	320	1175
▶ RLS 500/E-EV MX	815	890	1325	544	390	370	605	DN80	164	1055	342	320	1175
▶ RLS 650/E-EV MX	880	950	1325	562	360	410	630	DN80	164	1055	427	320	1190
▶ RLS 800/E-EV MX	940	937	1325	558	382	428	630	DN80	164	1055	427	320	1190

* Maximum depth of the boiler door including the depth of the burner flange insulating gasket.

BURNER - BOILER MOUNTING FLANGE

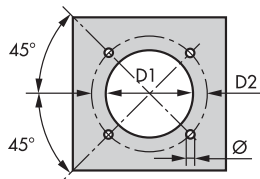

MODEL	D1	D2	Ø
▶ RLS 300/E-EV MX	350	452	M18
▶ RLS 400/E-EV MX	350	452	M18
▶ RLS 500/E-EV MX	390	452	M18
▶ RLS 650/E-EV MX	440	495	M18
▶ RLS 800/E-EV MX	440	495	M18

PACKAGING

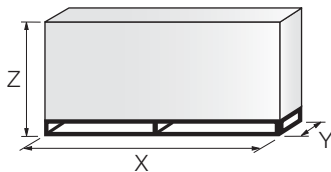

MODEL	X	Y	Z	kg
▶ RLS 300/E-EV MX	1960	970	1100	280
▶ RLS 400/E-EV MX	1960	970	1100	290
▶ RLS 500/E-EV MX	1960	970	1100	300
▶ RLS 650/E-EV MX	2035	1195	1130	320
▶ RLS 800/E-EV MX	2000	1180	1130	320

Low NOx Modulating Dual Fuel Burners

RLS 300-800/E-EV MX SERIES

Specification

DESIGNATION OF SERIES

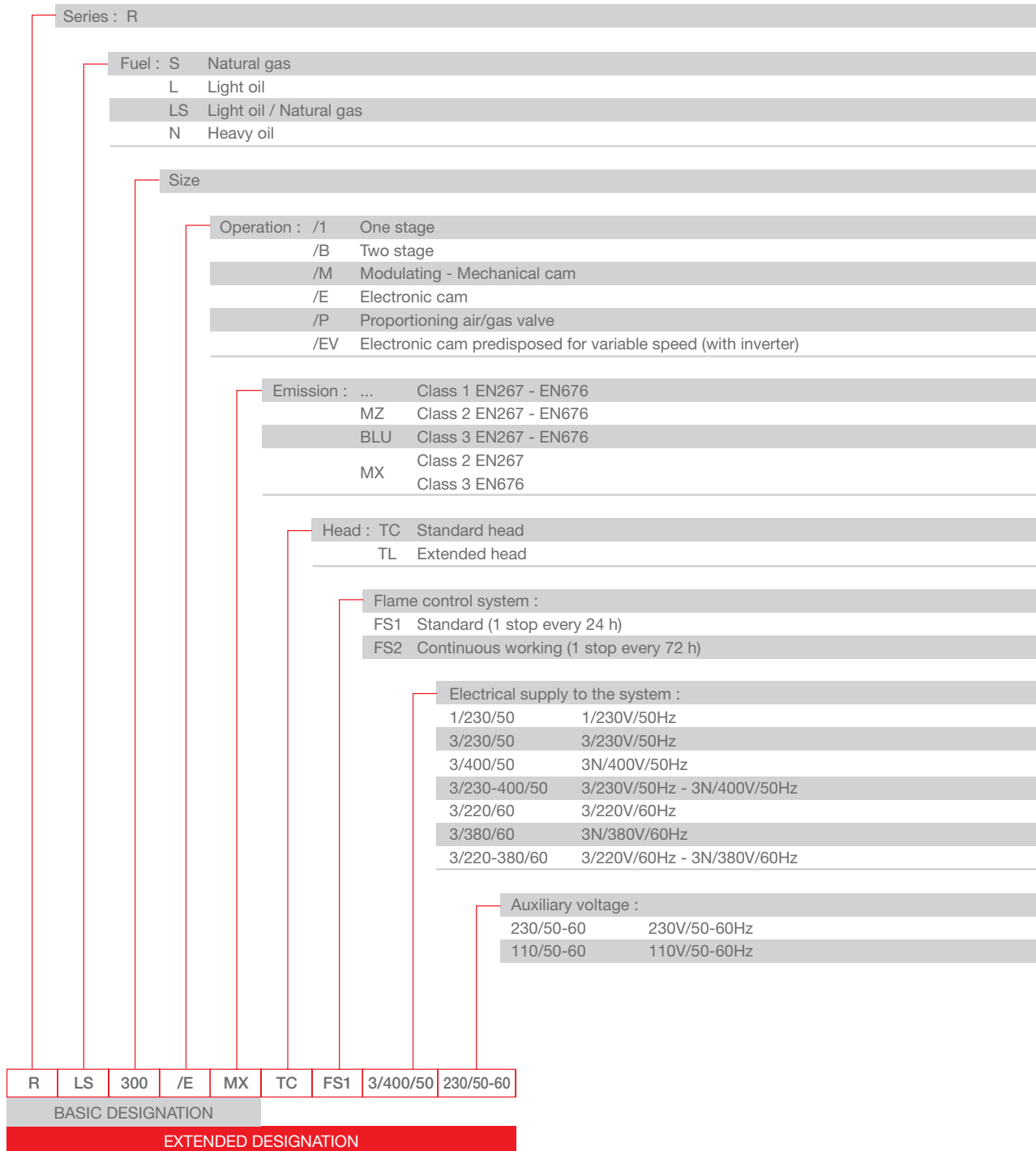

Low NOx Modulating Dual Fuel Burners

RLS 300-800/E-EV MX SERIES

Specification

STATE OF SUPPLY

Monoblock forced draught gas burner with modulating operation, fully automatic, made up of:

- High performance fan with low sound emissions, reverse curve blades for RLS 300-400/E-EV MX, forward curve blades for RLS 500-650-800/E-EV MX
- Air suction circuit lined with sound-proofing material
- Air damper for air setting controlled by a high precision servomotor
- Air pressure switch
- Fan starting motor at 2800 rpm, three-phase 230/400 - 400/690 V with neutral, 50Hz
- Separate light oil pump
- Low emission combustion head, that can be set on the basis of required output, fitted with:
 - stainless steel end cone, resistant to corrosion and high temperatures
 - ignition electrodes
 - ignition by gas pilot with gas train for RLS 650 and RLS 800 models
 - flame stability disk
- Maximum gas pressure switch, with pressure test point, for halting the burner in the case of over pressure on the fuel supply line
- Digital Burner management system for air/fuel setting; with output PID modulation control included on RLS/EV MX models, as accessory on RLS/E MX models
- Electronic cam for controlling the system safety
- Infrared flame detector
- Star/triangle starter for the fan motor (burners with motor electrical power $\geq 7,5$ kW - RLS/E versions)
- Main electrical supply terminal board
- Burner on/off switch
- Auxiliary voltage led signal
- Burner working led signal
- Contacts motor and thermal relay with release button
- Motor internal thermal protection
- Motor failure led signal
- Burner failure led signal and lighted release button
- Emergency button
- Coded connection plugs-sockets
- Burner opening hinge
- Lifting rings
- IP 54 electric protection level
- Gears pump for high pressure fuel supply
- Pump starting motor
- Oil safety valves
- Valve unit with double oil safety valve on the output circuit and double safety valve on the return circuit
- Oil/Gas selector
- Flame inspection window.

Standard equipment:

- 1 flange gasket
- 4 screws for fixing the flange
- 1 thermal screen
- 4 screws for fixing the burner flange to the boiler
- 2 flexible pipes for connection to the oil supply network
- 2 nipples for connection to the pump with gaskets
- Seal control pressure switch (for installation on gas train)
- Instruction handbook for installation, use and maintenance
- Spare parts catalogue.

RLS 300-800/E-EV MX SERIES

Available models

Burners

CODE	MODEL					HEAT OUTPUT			TOTAL ELECTRICAL POWER (kW)	CERTIFICATION	NOTE
						(kW)	LIGHT OIL (kg/h)	NATURAL GAS (Nm ³ /h)			
3898530	RLS 300/E MX	TC	FS1	3/400/50	230/50-60	600/1250-3550	50/105-300	60/125-355	7,5	CE 0085BR0471	(1)(2)
3898632	RLS 400/E MX	TC	FS1	3/400/50	230/50-60	800/1800-4300	67/152-363	80/180-430	11,5	CE 0085BR0472	(1)(2)
3899632	RLS 500/E MX	TC	FS1	3/400/50	230/50-60	1120/2500-5050	95/211-426	112/250-505	15 (oil) 13 (gas)	CE 0085CL0207	(1)(2)
20026857	RLS 650/E MX	TC	FS1	3/400/50	230/50-60	1430/3000-6550	121/253-552	143/300-655	23,5 (oil) 19,5 (gas)	CE 0085CL0422	(2)(3)
3911132	RLS 800/E MX	TC	FS1	3/400/50	230/50-60	1750/3500-8000	148/295-675	175/350-800	26 (oil) 24 (gas)	CE 0085CL0422	(1)(2)
20022571	RLS 300/EV MX	TC	FS1	3/400/50	230/50-60	600/1250-3550	50/105-300	60/125-355	7,5	CE 0085BR0471	(1)(2)
20022570	RLS 400/EV MX	TC	FS1	3/400/50	230/50-60	800/1800-4300	67/152-363	80/180-430	11,5	CE 0085BR0472	(1)(2)
20005681	RLS 500/EV MX	TC	FS1	3/400/50	230/50-60	1120/2500-5050	95/211-426	112/250-505	15 (oil) 13 (gas)	CE 0085CL0207	(1)(2)
20026959	RLS 650/EV MX	TC	FS1	3/400/50	230/50-60	1430/3000-6550	121/253-552	143/300-655	23,5 (oil) 19,5 (gas)	CE 0085CL0422	(2)(3)
20011318	RLS 800/EV MX	TC	FS1	3/400/50	230/50-60	1750/3500-8000	148/295-675	175/350-800	26 (oil) 24 (gas)	CE 0085CL0422	(1)(2)

Net calorific value light oil: 11,8 kWh/kg; 10.200 kcal/kg - Viscosity at 20°C: 4-6 mm²/s (cSt).

Net calorific value G20 gas: 10 kWh/Nm³; 8.600 kcal/Nm³ - Density: 0,71 kg/Nm³.

(1) according to 90/396 - 89/336 (2004/108) - 73/23 (2006/95) - 92/42 EC Directive and EN 267 - 676 Norm.

(2) the burners are factory set for FS1 operation (1 stop every 24 h) but they can be switched to FS2 operation (continuous - 1 stop every 72 h) by changing the parameters through the AZL unit menu.

(3) according to 2009/142 EC - 73/23 (2006/95) - 89/336 (2004/108) - 92/42 EC Directive and EN 267 - 676 Norm.

Low NOx Modulating Dual Fuel Burners

RLS 300-800/E-EV MX SERIES

Available models

Gas Trains

GAS TRAIN CODE*	GAS TRAIN MODEL	NATURAL GAS BURNER (type)	ADAPTER (code)	NOTE
3970221 3970146	MBC 1200 SE 50 CB 50/1	RLS 300/E-EV MX	3000826	(1)
		RLS 400/E-EV MX		(1)
3970222 3970147	MBC 1900 SE 65 FC CBF 65/1	RLS 300/E-EV MX	3010221	(1) (1)
		RLS 400/E-EV MX		
		RLS 500/E-EV MX		
		RLS 650/E-EV MX		
		RLS 800/E-EV MX		
3970223 3970148	MBC 3100 SE 80 FC CBF 80/1	RLS 300/E-EV MX	3010222	(1) (1)
		RLS 400/E-EV MX		
		RLS 500/E-EV MX		
		RLS 650/E-EV MX		
		RLS 800/E-EV MX		
3970224 3970149	MBC 5000 SE 100 FC CBF 100/1	RLS 300/E-EV MX	3010223	(1) (1)
		RLS 400/E-EV MX		
		RLS 500/E-EV MX		
		RLS 650/E-EV MX		
		RLS 800/E-EV MX		

* gas train are 230V/50Hz - 220V/60Hz electrical supply

(1) The seal control is managed by the control box LMV 51.

To select the gas train please refer to the technical data leaflet and/or instruction manual.

RLS 300-800/E-EV MX SERIES

Burner accessories

Nozzles

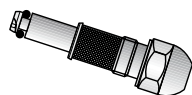

The nozzles must be ordered separately. The following table shows the features and codes on the basis of the maximum required fuel output.

BURNER	RATED DELIVERY (kg/h)	NOZZLE CODE
▶ RLS 300-400/E-EV MX	150	3009363
▶ RLS 300-400/E-EV MX	200	3009364
▶ RLS 300-400/E-EV MX	225	3009365
▶ RLS 300-400/E-EV MX	250	3009366
▶ RLS 300-400/E-EV MX	275	3009367
▶ RLS 300-400/E-EV MX	300	3009368
▶ RLS 400/E-EV MX	325	3009369
▶ RLS 400/E-EV MX	350	3009370
▶ RLS 400/E-EV MX	375	3009371
▶ RLS 400/E-EV MX	400	3009372
▶ RLS 400/E-EV MX	425	3009373
▶ RLS 500/E-EV MX	350	3045495
▶ RLS 500/E-EV MX	400	3045499
▶ RLS 500/E-EV MX	450	3045501
▶ RLS 500/E-EV MX	500	3045503
▶ RLS 650/E-EV MX	350	3045495
▶ RLS 650/E-EV MX	450	3045501
▶ RLS 650/E-EV MX	550	3045505
▶ RLS 650/E-EV MX	600	3045507
▶ RLS 800/E-EV MX	375	3009332
▶ RLS 800/E-EV MX	550	3009346
▶ RLS 800/E-EV MX	650	3009352
▶ RLS 800/E-EV MX	750	3009356

Accessories for modulating operation



To obtain modulating operation, the RLS/E MX series of burners requires a regulator. In RLS/EV models PID regulator is integrated inside LMV 52 control box.

BURNER	REGULATOR TYPE	REGULATOR CODE
▶ RLS 300-400-500-650-800/E MX	RWF 40 Basic version with 3 position output	3010356
▶ RLS 300-400-500-650-800/E MX	RWF 40 High version with additional modulating output and RS 485 Interface	3010357

The relative temperature or pressure probes fitted to the regulator, must be chosen on the basis of the application.



BURNER	PROBE TYPE	RANGE (°C) (bar)	PROBE CODE
▶ RLS/E-EV MX	Temperature PT 100	-100 ÷ 500°C	3010110
▶ RLS/E-EV MX	Pressure 4 ÷ 20 mA	0 ÷ 2,5 bar	3010213
▶ RLS/E-EV MX	Pressure 4 ÷ 20 mA	0 ÷ 16 bar	3010214

Low NOx Modulating Dual Fuel Burners

RLS 300-800/E-EV MX SERIES

Burner accessories

Variable Speed Drive (VSD) for RLS/EV series only



The motor speed variation for the RLS/EV MX burners series is obtained thanks to a frequency converter: variable speed drive (VSD). It always must be ordered with RLS/EV series.

BURNER	KIT CODE
▶ RLS 300-400/EV MX	3010379
▶ RLS 500/EV MX	20007233
▶ RLS 650/EV MX	20027615
▶ RLS 800/EV MX	3010468

Oxygen Control kit (QGO₂)



The QGO₂ is an oxygen analyzer with relevant probe which controls and supervises the residual oxygen content in exhaust gases.

BURNER	KIT CODE
▶ All models	3010378

PC Interface Software (ACS 450)

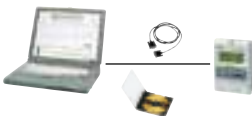

PC tool for convenient programming and burner settings, process visualization, data recording, selection of AZL language, software update AZL.

BURNER	KIT CODE
▶ All models	3010388

Kit efficiency with oxygen control kit (for RLS/EV only)



The kit includes two temperature sensors: one for air and one for exhaust gas detection. They must be wired to oxygen control kit interface to allow the LMV 52 efficiency calculation. The value is showed on AZL display.

BURNER	KIT CODE
▶ All models	3010377

LPG kit



For burning LPG gas, a special kit is available to be fitted to the combustion head on the burner.

BURNER	KIT CODE
▶ RLS 300-400/E-EV MX	in progress
▶ RLS 500-650-800/E-EV MX	in progress

Low NOx Modulating Dual Fuel Burners

RLS 300-800/E-EV MX SERIES

Burner accessories

Display and Operating Unit (AZL)



This tool is needed for combustion system commissioning and monitoring. The AZL is included in RLS/EV models.

BURNER	KIT CODE
► RLS 300-400-500-650-800/E MX	3010355
► All models *	3010469

* for Russian language only

Sound proofing box

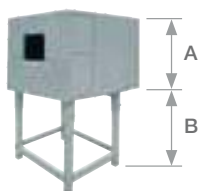

If noise emission needs reducing even further, sound-proofing boxes are available.

BURNER	BOX TYPE	A (mm)	B (mm) min-max	[dB(A)] (*)	BOX CODE
► All models	C7	1255	160 - 980	10	3010376

(*) Average noise reduction according to EN 15036-1 standard

Spacer kit



If burner head penetration into the combustion chamber needs reducing, varying thickness spacers are available, as given in the following table:

BURNER	SPACER THICKNESS S (mm)	KIT CODE
► All models	180	20008903

Low NOx Modulating Dual Fuel Burners

RLS 300-800/E-EV MX SERIES

Gas train accessories

Adapters

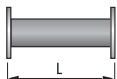

In certain cases, an adapter must be fitted between the gas train and the burner, when the diameter of the gas train is different from the set diameter of the burner. Below are given the adapters that can be fitted on the various burners:

BURNER	GAS TRAIN	ADAPTER TYPE	DIMENSIONS	L mm	ADAPTER CODE
► All models	CB 50/1 MBC 1200 SE 50	I	2" DN 80	300	3000826
	CBF 65/1 MBC 1900 SE 65 FC	I	DN 65 DN 80	400	3010221
	CBF 65/1 MBC 1900 SE 65 FC	I	DN 65 DN 80	10	3010369
	CBF 80/1 MBC 3100 SE 80 FC	I	DN 80 DN 80	400	3010222
	CBF 100/1 MBC 5000 SE 100 FC	I	DN 100 DN 80	400	3010223
	CBF 100/1 MBC 5000 SE 100 FC	I	DN 100 DN 80	50	3010370

Stabiliser spring



To vary the pressure range of the gas train stabilisers, accessory springs are available. The following table shows these accessories with their application range. Please refer to the technical manual for the correct choice of spring.

GAS TRAIN	SPRING	SPRING CODE
MBC 1900 SE 65 FC ► MBC 3100 SE 80 FC MBC 5000 SE 100 FC	White from 4 to 20 mbar	3010381
	Red from 20 to 40 mbar	3010382
	Black from 40 to 80 mbar	3010383
	Green from 80 to 150 mbar	3010384
► CBF 65/1 - CBF 80/1	Red from 25 to 55 mbar	3010133
► CBF 100/1	Red from 25 to 55 mbar	3010134
► CBF 65/1 - CBF 80/1	Black from 60 to 110 mbar	3010135
► CBF 100/1	Black from 60 to 110 mbar	3010136
► CBF 65/1 - CBF 80/1	Pink from 100 to 150 mbar	3090456
► CBF 100/1	Pink from 100 to 150 mbar	3090489