

MODULATING LIGHT OIL BURNERS

▶ RL/M SERIES

▶ RL 28/M	95/166 ÷ 332 kW
▶ RL 38/M	101/237 ÷ 450 kW
▶ RL 50/M	130/296 ÷ 593 kW
▶ RL 70/M	261/474 ÷ 1043 kW
▶ RL 100/M	332/711 ÷ 1482 kW
▶ RL 130/M	498/948 ÷ 1779 kW
▶ RL 190/M	534/1423 ÷ 2431 kW

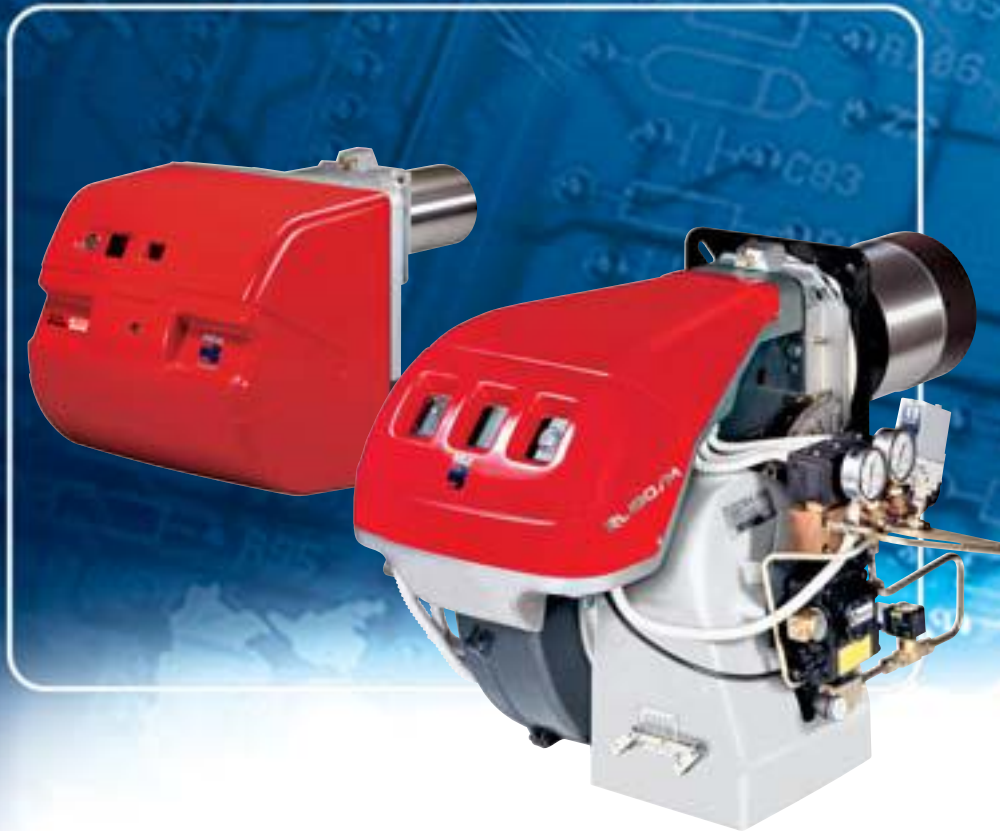

The RL/M series of burners covers a firing range from 166 to 2431 kW, and they have been designed for use in hot or superheater water boilers, hot air or steam generators, diathermic oil boilers.

Operation can be "two stage progressive" or, alternatively, "modulating" with the installation of a PID logic regulator and respective probes.

RL/M series burners guarantees high efficiency levels in all the various applications, thus reducing fuel consumption and running costs.

Optimisation of sound emissions is guaranteed by the use of fans with forward inclined blades and sound deadening material incorporated in the air suction circuit.

The exclusive design ensures reduced dimensions, simple use and maintenance. A wide range of accessories guarantees elevated working flexibility.



TECHNICAL DATA

Model		▼ RL 28/M	▼ RL 38/M	▼ RL 50/M	▼ RL 70/M	▼ RL 100/M	▼ RL 130/M	▼ RL 190/M
Burner operation mode		Modulating (with regulator and probes accessories)						
Modulation ratio at max. output		3 ÷ 1						
Servomotor	type	SQN90			SQN31			
	run time	24			42			
Heat output	kW	95/166÷332	101/237÷450	130/296÷593	261/474÷1043	332/711÷1482	498/948÷1779	534/1423÷2431
	Mcal/h	81,7/143÷286	87/204÷387	112/255÷510	224/408÷897	286/612÷1275	428/816÷1530	459/1224÷2091
	kg/h	8/14÷28	8,5/20÷38	11/25÷50	22/40÷88	28/60÷125	42/80÷150	45/120÷205
Working temperature	°C min./max.	0/40						
Net calorific value	kWh/kg	11,8						
	kcal/kg	10200						
Viscosity	mm ² /s (cSt)	4 ÷ 6 (at 20°C)						
Pump	type	AL 75C	AL 95C		J 7C		TA 3	
	delivery	74 (20 bar)	99 (20 bar)		190 (20 bar)		665 (20 bar)	
Atomised pressure	bar	20						
Fuel temperature	Max. °C	50						
Fuel pre-heater								
Fan	type	Centrifugal with reverse curve blades						Forward curve blades
Air temperature	Max. °C	60						
Electrical supply	Ph/Hz/V	1/50/230~(±10%)	3N/50/400~(±10%)					3/50/230~(±10%) △
Auxiliary electrical supply	Ph/Hz/V	1/50/230~(±10%)						
Control box	type	LAL 1.25			LAL 1.25 (Intermittent working) - LOK 16 (Continuous working)			
Total electrical power	kW	0,4	0,6	0,8	1,4	2,1	2,6	5,5
Auxiliary electrical power	kW	0,15	0,15	0,15	0,3	0,3	0,4	1
Heaters electrical power	kW							
Protection level	IP	44						
Pump motor electrical power	kW	--						
Rated pump motor current	A	--						
Pump motor start up current	A	--						
Pump motor protection level	IP	--						
Fan motor electrical power	kW	0,25	0,45	0,65	1,1	1,8	2,2	4,5
Rated fan motor current	A	2,1	2 - 1,2	3 - 1,7	4,8 - 2,8	7,3 - 4,2	8,8 - 5,1	15,8 - 9,1
Fan motor start up current	A	10	9,5 - 5,5	13,8 - 8	25 - 14,6	37,6 - 21,8	57,2 - 33,2	126 - 73
Fan motor protection level	IP	40	54					
Ignition transformer	type							
	V1 - V2	230V - 2x5 kV						230V - 2x5 kV
	I1 - I2	1,9A - 30 mA						1,9A - 35 mA
Operation		Intermittent (at least one stop every 24 h)			Intermittent (at least one stop every 24 h) - Continuous (at least one stop every 72 h)			
Sound pressure	dB(A)	68	70	75	75	77	78,5	84,9
Sound power	W	--						
CO emission	mg/kWh	< 40						
Grade of smoke indicator	N° Bacharach	< 1						
C _x H _y emission	mg/kWh	<10 (after the first 20 s)						
NO _x emission	mg/kWh	< 200						
Directive		73/23 - 89/336/EC - 2004/108/EC - 98/37 - 92/42 EC						
Conforming to		EN 267						
Certification		--			CE-050790223001			

Reference conditions:

Temperature: 20°C

Pressure: 1013,5 mbar

Altitude: 100 m a.s.l.

Noise measured at a distance of 1 meter.

Since the Company is constantly engaged in the production improvement, the aesthetic and dimensional features, the technical data, the equipment and the accessories can be changed.

This document contains confidential and proprietary information of RIELLO S.p.A. Unless authorised, this information shall not be divulged, nor duplicated in whole or in part.



FIRING RATES

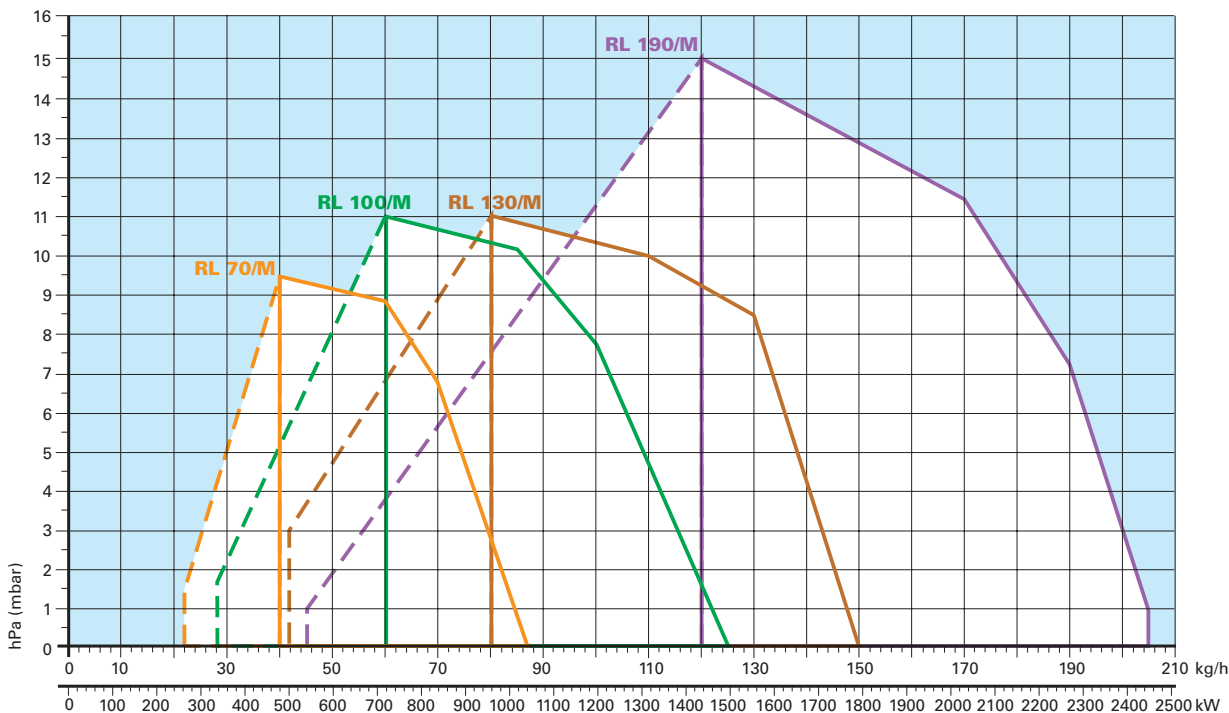
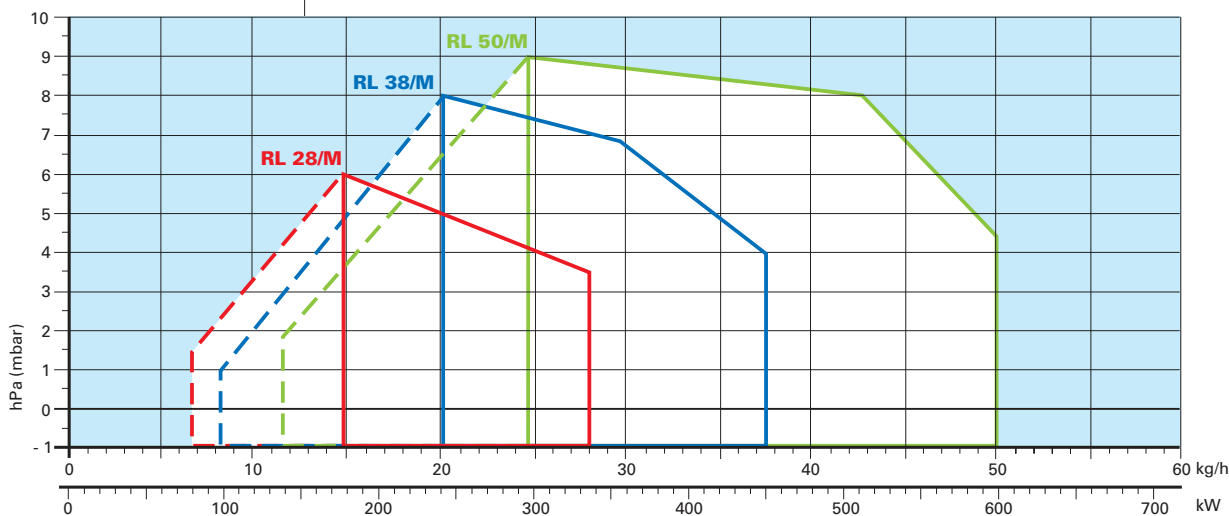

Useful working field for choosing the burner

Modulation range

Test conditions conforming to EN 267:

Temperature: 20°C
 Pressure: 1013,5 mbar
 Altitude: 100 m a.s.l.





FUEL SUPPLY

HYDRAULIC CIRCUITS

Various hydraulic circuits are available, depending on fuel output asset according to local norms of steam generators.

The burners are fitted with two valves for oil output from the pump: a pressure regulator on the return circuit from the nozzle allows varying the quantity of burnt fuel.

A safety valve on the return circuit impedes oil leakage from the nozzle when the burner is in stand by and pre-purge phases.

Beginning with the RL 100/M model, the burners have a double safety valve on the return circuit.

The models fitted with a minimum pressure switch on the oil delivery circuit can be installed on steam generators according to TRD-72 standard (Germany) and NBN standard (Belgium).



Example of the hydraulic circuit on RL70/M burners

EN 267 < 100 Kg/h

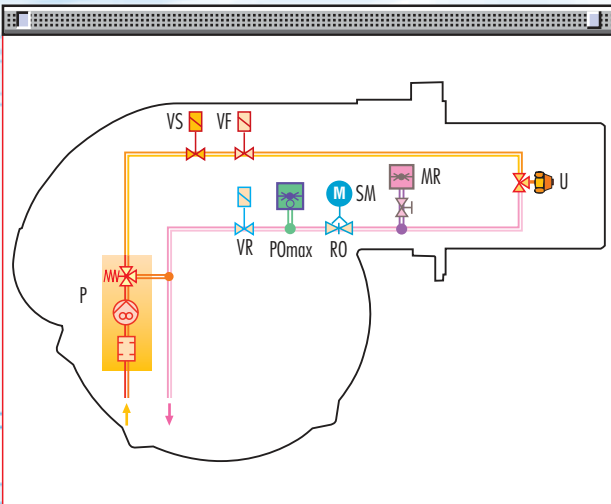

P	Pump with filter and pressure regulator on the output circuit
VS	Safety valve on the output circuit
VF	Working valve on the output circuit
PO min	Min. Oil pressure switch on the output circuit
U	Nozzle
MR	Pressure gauge on the return circuit
SM	Servomotor
RO	Pressure regulator on the return circuit
PO max	Max. Oil pressure switch on the return circuit
VR	1st safety valve on the return circuit
VR1	2nd safety valve on the return circuit

EN 267 > 100 Kg/h

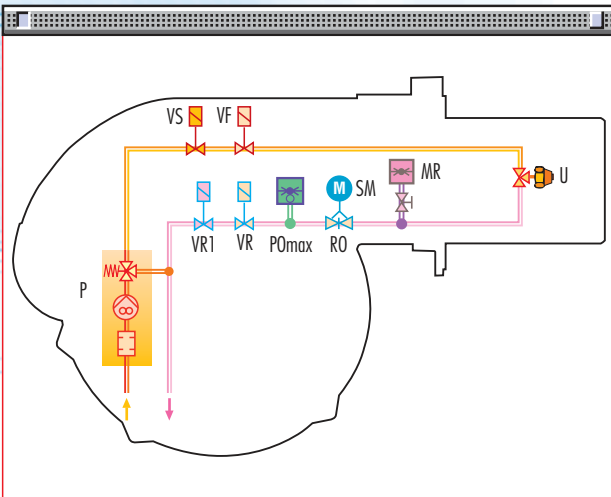

Versions for TRD-72, NBN steam generators

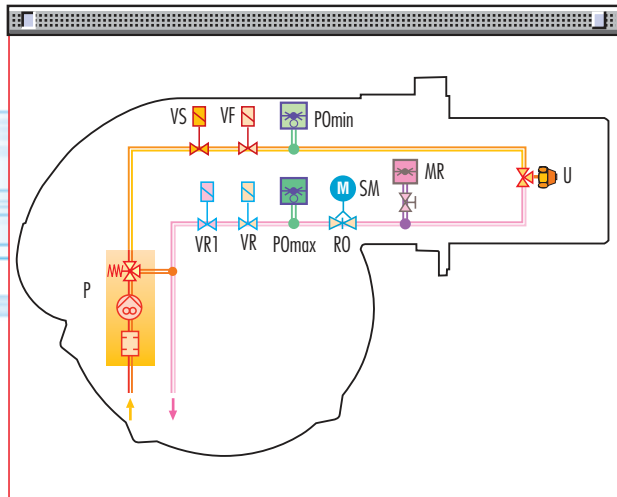



SELECTING THE FUEL SUPPLY LINES

The fuel feed must be completed with the safety devices required by the local norms.

The table shows the choice of piping diameter for the various burners, depending on the difference in height between the burner and the tank and their distance.

MAXIMUM EQUIVALENT LENGTH FOR THE PIPING L[m]											
Model	▼ RL28/M			▼ RL38-50/M			▼ RL70-100-130/M			▼ RL190/M	
Diameter piping	Ø10mm	Ø12mm	Ø14mm	Ø10mm	Ø12mm	Ø14mm	Ø12mm	Ø14mm	Ø16mm	Ø16mm	Ø18mm
+H, -H (m)	L _{max} (m)	L _{max} (m)	L _{max} (m)	L _{max} (m)	L _{max} (m)	L _{max} (m)	L _{max} (m)	L _{max} (m)	L _{max} (m)	L _{max} (m)	L _{max} (m)
+4,0	83	144	150	51	112	150	71	138	150	60	80
+3,0	55	127	150	46	99	150	62	122	150	50	70
+2,0	48	111	150	39	86	150	58	106	150	40	60
+1,5	44	102	150	35	79	147	51	98	150	35	55
+1,0	40	94	150	32	73	144	44	90	150	30	50
+0,5	37	86	150	29	65	132	40	82	150	25	45
0	33	78	150	26	60	120	36	74	137	20	40
-0,5	29	70	133	23	54	106	32	66	123	18	35
-1,0	25	82	118	20	47	96	28	56	109	15	30
-1,5	21	63	103	16	40	83	23	49	95	13	25
-2,0	17	45	88	13	34	71	19	42	81	10	20
-3,0	10	29	58	7	21	46	10	26	53	5	10
-4,0	4	12	28	2	8	21	3	10	25	3	6

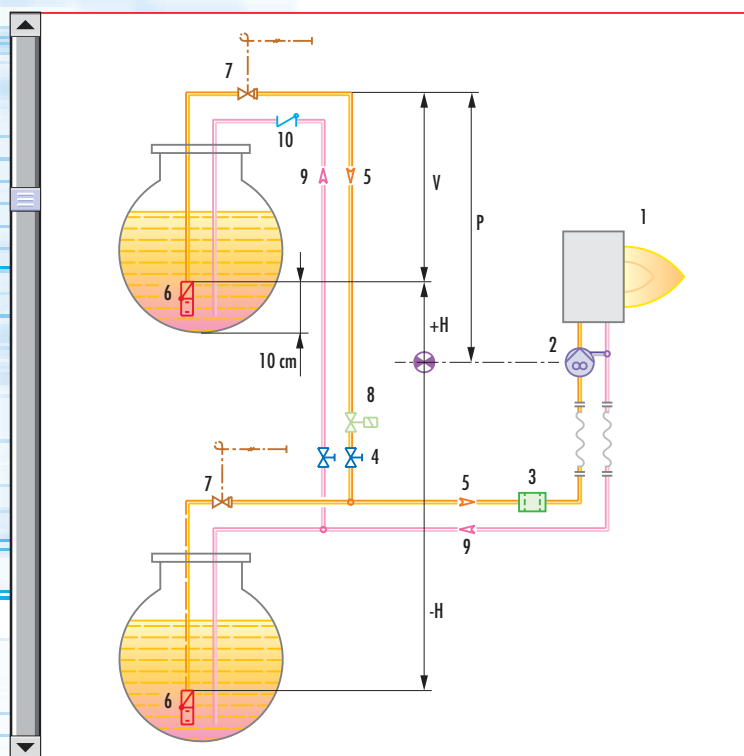

H	Difference in height pump-foot valve
Ø	Internal pipe diameter
P	Height 10 m
V	Height 4 m
1	Burner
2	Burner pump
3	Filter
4	Manual shut off valve
5	Suction pipework
6	Bottom valve
7	Remote controlled rapid manual shut off valve (compulsory in Italy)
8	Type approved shut off solenoid valve (compulsory in Italy)
9	Return pipework
10	Check valve

note With ring distribution oil systems, the feasible drawings and dimensioning are the responsibility of specialised engineering studios, who must check compatibility with the requirements and features of each single installation.



VENTILATION

The ventilation circuit produces low noise levels with high performance pressure and air output, in spite of the compact dimensions.

Except for the RL 190/M model, the use of reverse curve blades and sound proofing material keeps noise level very low.

In the RL 190/M model, sound has been reduced by the special design of the air suction circuit.

A variable profile cam connects fuel and air setting, ensuring high fuel efficiency in all firing ranges.



Example of the servomotor for air/oil setting



COMBUSTION HEAD

Different lengths of the combustion head can be chosen for the RL/M series of burners.

The choice depends on the thickness of the front panel and the type of boiler.

Depending on the type of generator, check that the penetration of the head into the combustion chamber is correct.

The internal position of the combustion head can easily be adjusted to the maximum defined output by adjusting a screw fixed to the flange.

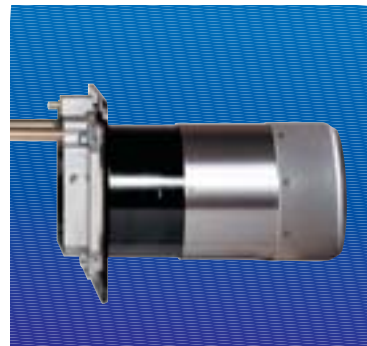

Example of a RL/M burner combustion head

Flame dimensions

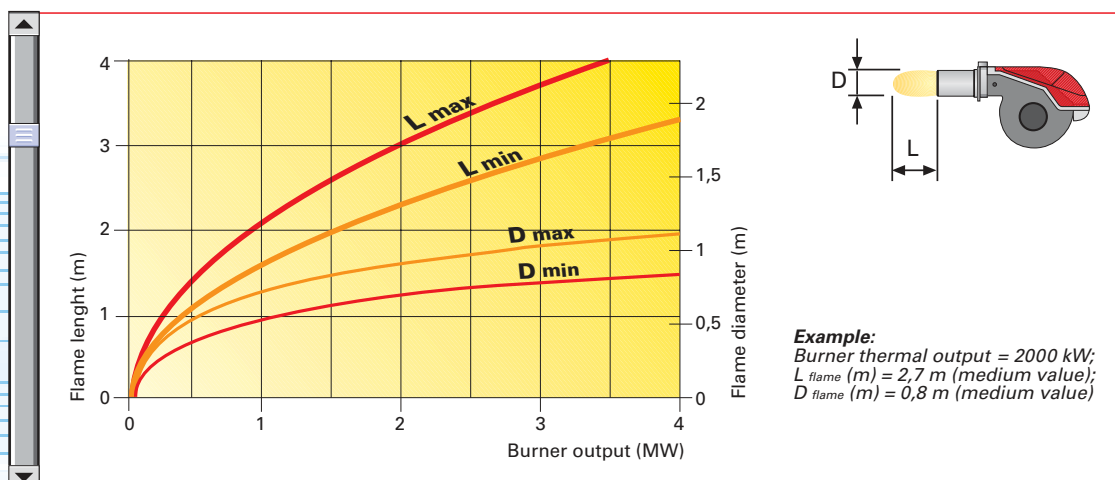

OPERATION



BURNER OPERATION MODE

The RL/M series of burners can have "two-stage progressive" or "modulating" operation.

On "two-stage progressive" operation, the burner gradually adapts the output to the requested level, by varying between two pre-set levels (see picture A).

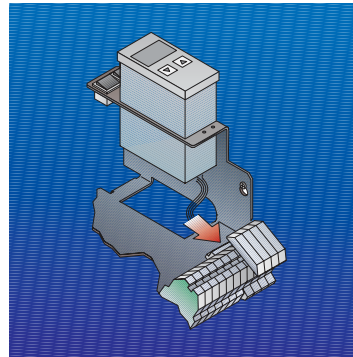

Example of a regulator

"Two-stage progressive" operation

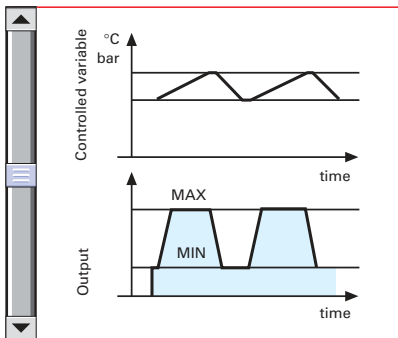

Picture A

"Modulating" operation

On "modulating" operation, normally required in steam generators, in superheater boilers or diathermic oil burners, a specific regulator and probes are required. These are supplied as accessories that must be ordered separately. The burner can work for long periods at intermediate output levels (see picture B).

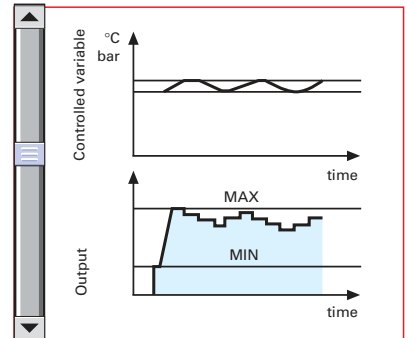

Picture B

START UP CYCLE

RL 28/M - 38/M - 50/M

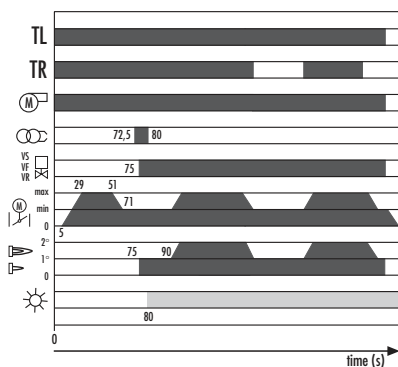

- 0" The burner begins the firing cycle: the motor starts turning.
- 5"-29" The servomotor opens the air damper.
- 29"-51" Pre-purge with the air damper open.
- 51"-71" The servomotor takes the air damper to the firing position.
- 72.5" Pre-ignition.
- 75" Firing: all the oil solenoid valves are supplied.
- 90" Output can be increased.

RL 70/M - 100/M - 130/M - 190/M

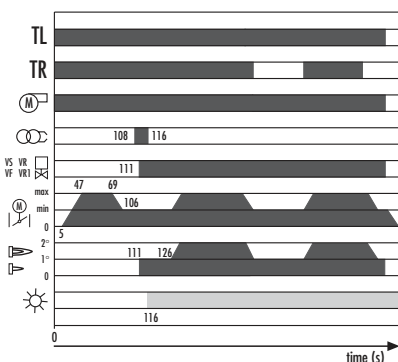

- 0" The burner begins the firing cycle: the motor starts turning.
- 5"-47" The servomotor opens the air damper.
- 47"-69" Pre-purge with the air damper open.
- 69"-106" The servomotor takes the air damper to the firing position.
- 108" Pre-ignition.
- 111" Firing: all the oil solenoid valves are supplied.
- 126" Output can be increased.



WIRING DIAGRAMS



Electrical connections must be made by qualified and skilled personnel, according to the local norms.



Example of the terminal board for electrical connections for the RL 70-100-130-190/M models

“TWO-STAGE PROGRESSIVE” OPERATION

RL 28/M

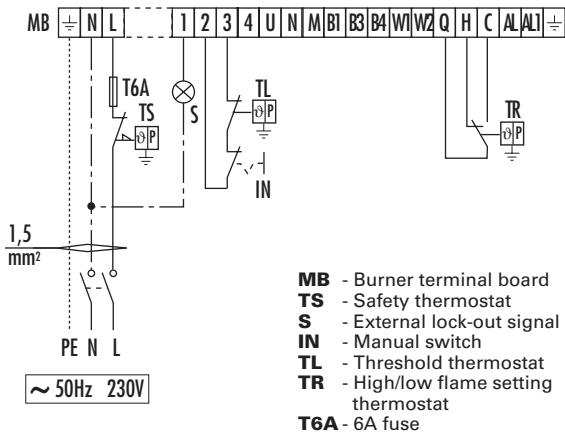

- MB** - Burner terminal board
- TS** - Safety thermostat
- S** - External lock-out signal
- IN** - Manual switch
- TL** - Threshold thermostat
- TR** - High/low flame setting thermostat
- T6A** - 6A fuse

RL 38/M - 50/M - 70/M - 100/M - 130/M - 190/M

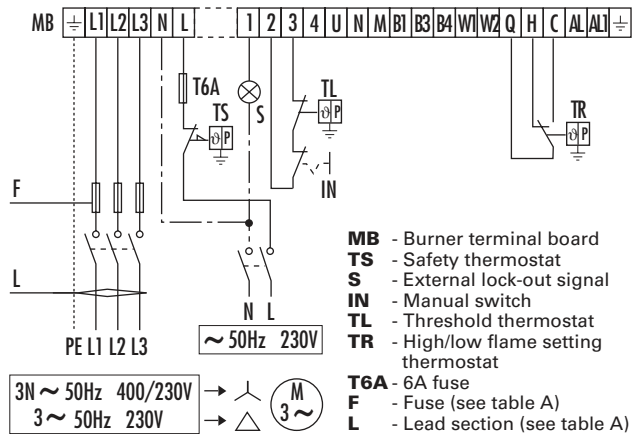

- MB** - Burner terminal board
- TS** - Safety thermostat
- S** - External lock-out signal
- IN** - Manual switch
- TL** - Threshold thermostat
- TR** - High/low flame setting thermostat
- T6A** - 6A fuse
- F** - Fuse (see table A)
- L** - Lead section (see table A)

“MODULATING” OPERATION - temperature probe

RL 28/M

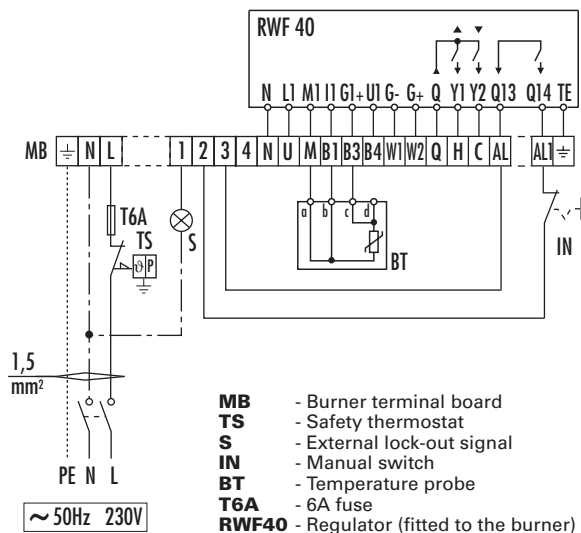

- MB** - Burner terminal board
- TS** - Safety thermostat
- S** - External lock-out signal
- IN** - Manual switch
- BT** - Temperature probe
- T6A** - 6A fuse
- RWF40** - Regulator (fitted to the burner)

RL 38/M - 50/M - 70/M - 100/M - 130/M - 190/M

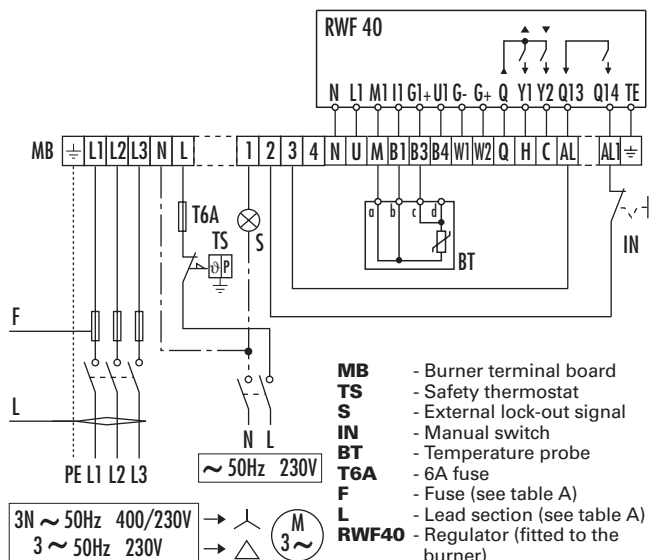

- MB** - Burner terminal board
- TS** - Safety thermostat
- S** - External lock-out signal
- IN** - Manual switch
- BT** - Temperature probe
- T6A** - 6A fuse
- F** - Fuse (see table A)
- L** - Lead section (see table A)
- RWF40** - Regulator (fitted to the burner)



“MODULATING” OPERATION - pressure probe

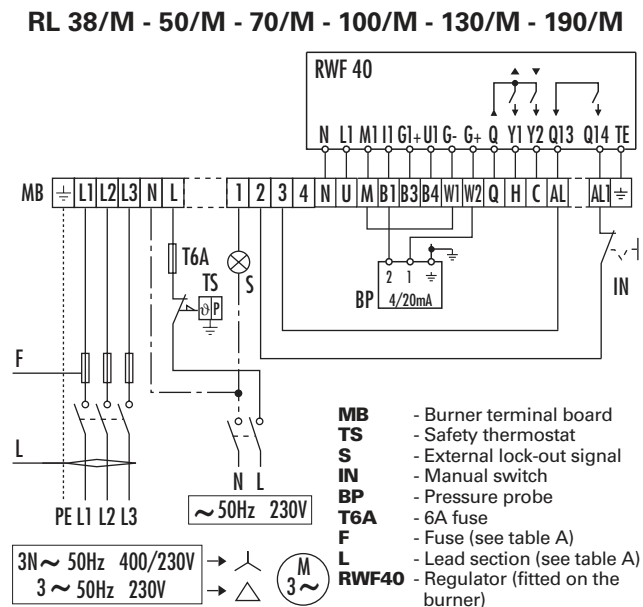
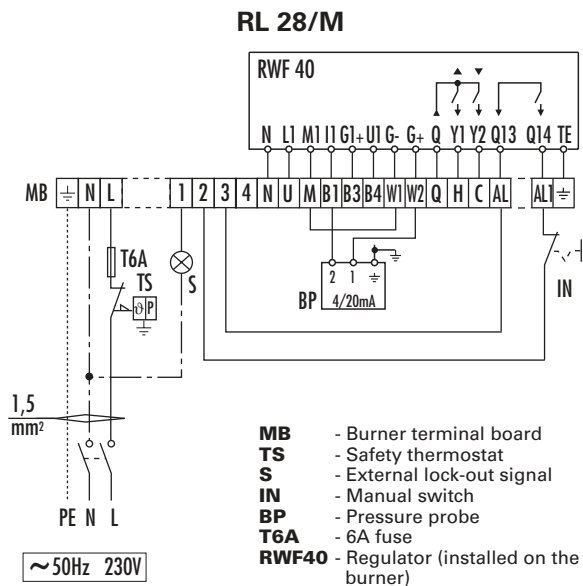

The following table shows the supply lead sections and the type of fuse to be used.

Model	▼ RL 28/M	▼ RL 38/M	▼ RL 50/M	▼ RL 70/M	▼ RL 100/M	▼ RL 130/M	▼ RL 190/M
	230V	230V	400V	230V	400V	230V	400V
F A	T6	T6	T6	T6	T6	T10	T6
L mm ²	1,5	1,5	1,5	1,5	1,5	1,5	1,5

Table A



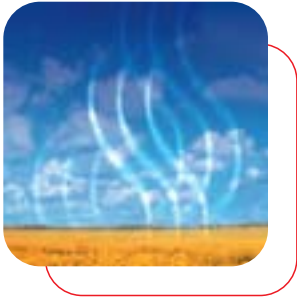

EMISSIONS



NO₂ EMISSIONS

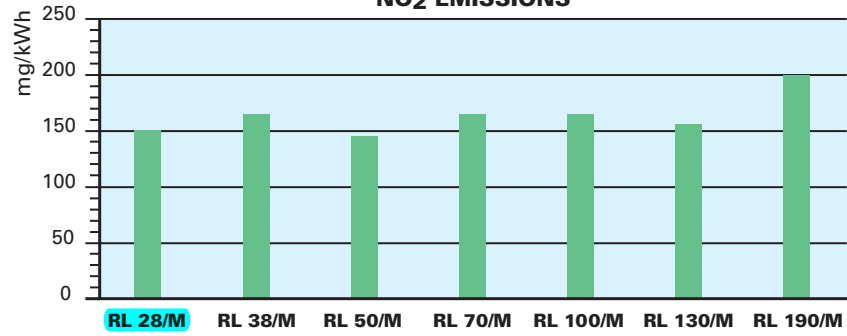

CO EMISSIONS

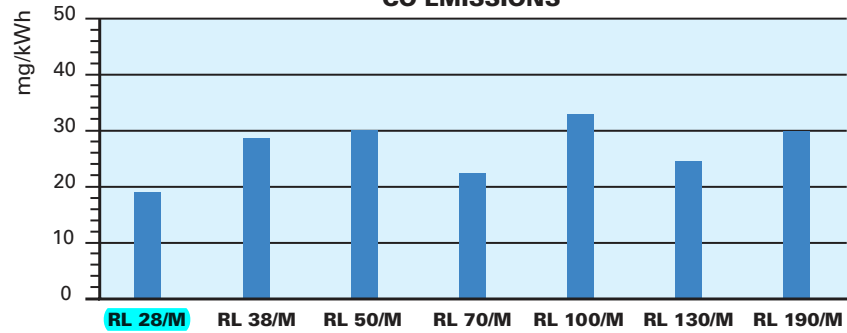

NOISE EMISSIONS

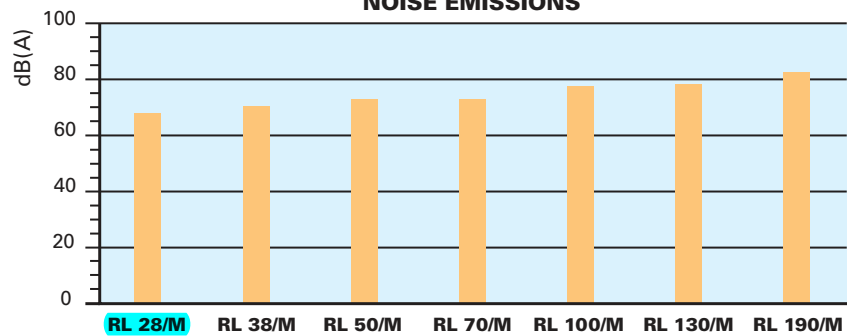

The emission data has been measured in the various models at maximum output, according to EN 267 standard.

OVERALL DIMENSIONS (mm)



BURNER

RL 28/M - 38/M - 50/M

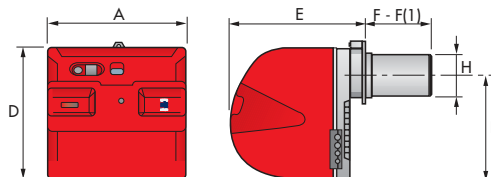

RL 70/M - 100/M - 130/M - 190/M

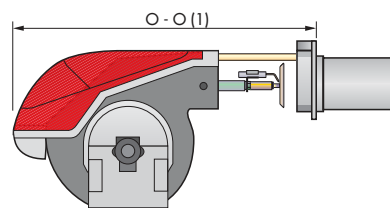
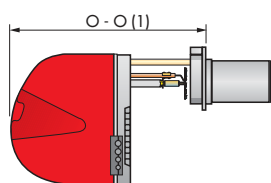
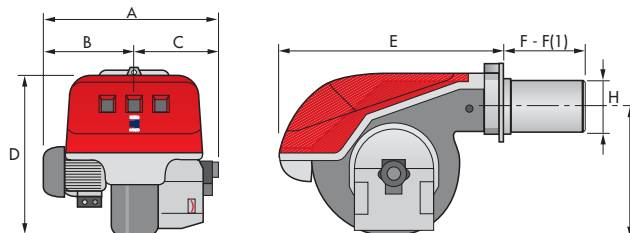

Model	A	B	C	D	E	F - F (1)	H	I	O - O (1)
▶ RL 28/M	476	-	-	474	468	241 - 351	140	352	672 - 807
▶ RL 38/M	476	-	-	474	468	241 - 351	140	352	672 - 807
▶ RL 50/M	476	-	-	474	468	241 - 351	152	352	672 - 807
▶ RL 70/M	663	296	367	555	680	272 - 385	179	430	951 - 1086
▶ RL 100/M	679	312	367	555	680	272 - 385	179	430	951 - 1086
▶ RL 130/M	705	338	367	555	680	272 - 385	189	430	951 - 1086
▶ RL 190/M	813	366	447	555	696	370 -	222	430	1102 -

(1) Length with extended combustion head

BURNER - BOILER MOUNTING FLANGE

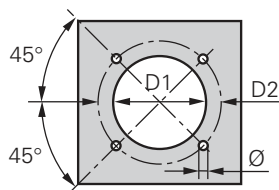

Model	D1	D2	Ø
▶ RL 28/M	160	224	M8
▶ RL 38/M	160	224	M8
▶ RL 50/M	160	224	M8
▶ RL 70/M	185	275-325	M12
▶ RL 100/M	185	275-325	M12
▶ RL 130/M	195	275-325	M12
▶ RL 190/M	230	325-368	M16

PACKAGING

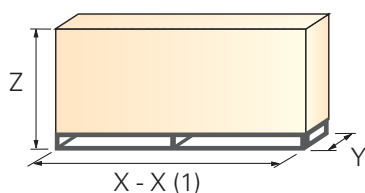

Model	X - X (1)	Y	Z	kg
▶ RL 28/M	872	540	550	39
▶ RL 38/M	872	540	550	41
▶ RL 50/M	872	540	550	42
▶ RL 70/M	1150	792	600	65
▶ RL 100/M	1150	792	600	68
▶ RL 130/M	1150	792	600	71
▶ RL 190/M	1200	800	850	95

(1) Length with extended combustion head



INSTALLATION DESCRIPTION

Installation, start up and maintenance must be carried out by qualified and skilled personnel.
All operations must be performed in accordance with the technical handbook supplied with the burner.

BURNER SETTING

- ▶ All the burners have slide bars, for easier installation and maintenance.
- ▶ After drilling the boilerplate, using the supplied gasket as a template, dismantle the blast tube from the burner and fix it to the boiler.
- ▶ Adjust the combustion head.
- ▶ Refit the burner casing to the slide bars.
- ▶ Install the nozzle, choosing this on the basis of the maximum boiler output and following the diagrams included in the burner instruction handbook.
- ▶ Check the position of the electrodes.
- ▶ Close the burner, sliding it up to the flange, keeping it slightly raised to avoid the flame stability disk rubbing against the blast tube.



HYDRAULIC / ELECTRICAL CONNECTIONS AND START-UP

- ▶ The burners are supplied for connection to two pipes fuel supply system.
- ▶ Connect the ends of the flexible pipes to the suction and return pipework using the supplied nipples.
- ▶ Make the electrical connections to the burner following the wiring diagrams included in the instruction handbook.
- ▶ Prime the pump by turning the motor (after checking rotation direction if it is a three phase motor).
- ▶ On start up, check:
 - Pressure pump and valve unit regulator (to max. and min.)
 - Combustion quality, in terms of unburned substances and excess air.



BURNER ACCESSORIES



Nozzles

The return nozzles must be ordered separately. The following table shows the features and codes on the basis of the maximum required fuel output.

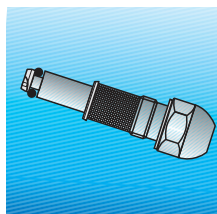

Nozzles type A3 45°		
Burner	Rated delivery (kg/h) (*)	Nozzle code
RL 28/M	15	3009850
RL 28/M - 38/M	20	3009851
RL 28/M - 38/M - 50/M	30	3009852
RL 38/M - 50/M - 70/M	40	3009853
RL 50/M - 70/M	50	3009854
RL 70/M - 100/M	60	3009855
RL 70/M - 100/M	70	3009856
RL 100/M - 130/M	80	3009857
RL 100/M - 130/M	90	3009858
RL 100/M - 130/M	100	3009859
RL 130/M	110	3009860
RL 130/M - 190/M	120	3009861
RL 130/M - 190/M	130	3009862
RL 190/M	140	3009863
RL 190/M	160	3009864
RL 190/M	180	3009865
RL 190/M	200	3009866

(*) Nozzle rated delivery is referred to atomised pressure

Extended head kit

“Standard head” burners can be transformed into “extended head” versions, by using the special kit. The kits available for the various burners, giving the original and the extended lengths, are listed below.

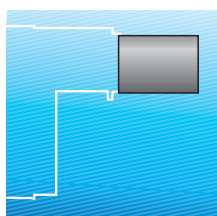

Extended head kit			
Burner	Standard head length (mm)	Extended head length (mm)	Kit code
RL 28/M	241	351	3010120
RL 38/M	241	351	3010121
RL 50/M	241	351	3010122
RL 70/M	272	385	3010159
RL 100/M	272	385	3010160
RL 130/M	272	385	3010161
RL 190/M	370	-	-



Spacer kit

If burner head penetration into the combustion chamber needs reducing, varying thickness spacers are available, as given in the following table:

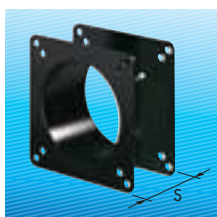

Spacer kit		
Burner	Spacer thickness S (mm)	Kit code
RL 28/M - 38/M - 50/M	90	3010095
RL 70/M - 100/M - 130/M	135	3010129
RL 190/M	110	3000722

Sound proofing box

If noise emission needs reducing even further, sound-proofing boxes are available, as given in the following table:



Sound proofing box			
Burner	Box type	Average noise reduction [dB(A)] (*)	Box code
RL 28/M - 38/M - 50/M	C1/3	10	3010403
RL 70/M - 100/M - 130/M - 190/M	C4/5	10	3010404

(*) according to EN 15036-1 standard

Degasing unit

To solve problem of air in the oil sucked, two versions of degasing unit are available.



Degasing unit			
Burner	Filter	Filtering degree (µm)	Degasing unit code
RL 28/M - 38/M - 50/M RL 70/M - 100/M	With filter	50 - 75	3010055
RL 28/M - 38/M - 50/M RL 70/M - 100/M	Without filter	-	3010054



Head kit for “reverse flame chamber”

In certain cases, the use of the burner on reverse flame boilers can be improved by using an additional cylinder.



Head kit for “reverse flame chamber”			
Burner	Standard head length with cylinder (mm)	Extended head length with cylinder(mm)	Kit code
RL 28/M - 38/M	319	429	3010178
RL 50/M	319	429	3010179
RL 70/M - 100/M	375	488	3010180
RL 130/M	375	488	3010183
RL 190/M	493	-	3010241

Connection flange kit

A kit is available for use where the burner opening on the boiler is of excessive diameter.

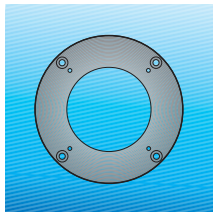

Connection flange kit	
Burner	Kit code
RL 28/M - 38/M - 50/M	3010138



Accessories for modulating operation

To obtain modulating operation, the RL/M series of burners requires a regulator with three point outlet controls. The following table lists the accessories for modulating operation with their application range.



Burner	Regulator type	Regulator code
RL 28/M - 38/M - 50/M	RWF 40	3010212
RL 70/M - 100/M - 130/M - 190/M		

The relative temperature or pressure probes fitted to the regulator must be chosen on the basis of the application.



Probe type	Range (°C) (bar)	Probe code
Temperature PT 100	-100 ÷ 500°C	3010110
Pressure 4 ÷ 20 mA	0 ÷ 2,5 bar	3010213
Pressure 4 ÷ 20 mA	0 ÷ 16 bar	3010214

Depending on the servomotor fitted to the burner, a three-pole potentiometer (1000 Ω) can be installed to check the position of the servomotor. The KITS available for the various burners are listed below.



Burner	Potentiometer kit code
RL 28/M - 38/M - 50/M	3010109
RL 70/M - 100/M - 130/M - 190/M	3010021

SPECIFICATION



A specific index guides your choice of burner from the various models available in the RL/M series. Below is a clear and detailed specification description of the product.

DESIGNATION OF SERIES

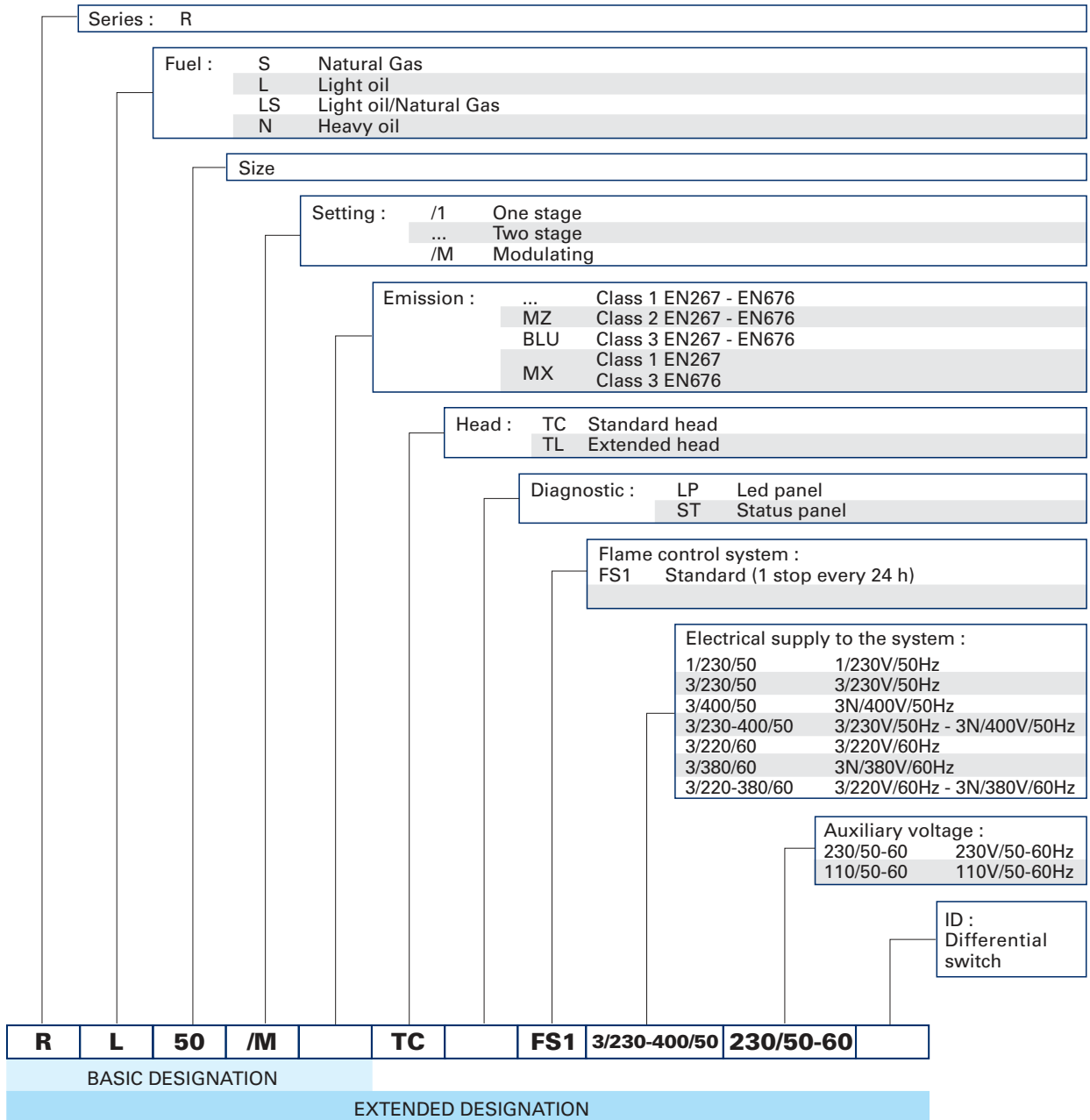



▶ AVAILABLE BURNER MODELS

RL 28/M TC FS1	1/230/50	230/50-60	RL 100/M TC FS1	3/230-400/50	230/50-60
RL 28/M TL FS1	1/230/50	230/50-60	RL 100/M TL FS1	3/230-400/50	230/50-60
RL 38/M TC FS1	3/230-400/50	230/50-60	RL 100/M TC FS2	3/230-400/50	230/50-60
RL 38/M TL FS1	3/230-400/50	230/50-60	RL 100/M TL FS2	3/230-400/50	230/50-60
RL 50/M TC FS1	3/230-400/50	230/50-60	RL 130/M TC FS1	3/230-400/50	230/50-60
RL 50/M TL FS1	3/230-400/50	230/50-60	RL 130/M TL FS1	3/230-400/50	230/50-60
RL 70/M TC FS1	3/230-400/50	230/50-60	RL 130/M TC FS2	3/230-400/50	230/50-60
RL 70/M TL FS1	3/230-400/50	230/50-60	RL 130/M TL FS2	3/230-400/50	230/50-60
RL 70/M TC FS2	3/230-400/50	230/50-60	RL 190/M TC FS1	3/230-400/50	230/50-60
RL 70/M TL FS2	3/230-400/50	230/50-60	RL 190/M TC FS2	3/230-400/50	230/50-60

Other versions are available on request.

▶ PRODUCT SPECIFICATION

Burner:

Monoblock forced draught oil burner with two stage progressive or modulating setting, with a specific kit, fully automatic, made up of:

- air suction circuit lined with sound-proofing material
- fan with reverse curve blades (forward curve blades on the 190/M model) high performance with low sound emissions
- air damper for air setting and automatic oil output regulator controlled by a servomotor with variable cam
- starting motor at 2800 rpm, three-phase 400V with neutral, 50Hz (single-phase, 230V and 50Hz for the 28/M model)
- combustion head, that can be set on the basis of required output, fitted with:
 - stainless steel end cone, resistant to corrosion and high temperatures
 - ignition electrodes
 - flame stability disk
- gears pump for high pressure fuel supply, fitted with:
 - filter
 - pressure regulator
 - connections for installing a pressure gauge and vacuumeter
 - internal by-pass for single pipe installation
- valve unit with a double oil safety valve on the output circuit and safety valve on the return circuit; double safety valve on the return circuit for models RL 100/M, RL 130/M, RL 190/M and for all models in the TRD-72, NBN version
- safety oil pressure switch for stop the burner in case of problems in the return circuit
- minimum oil pressure switch in the output circuit for the TRD-72, NBN versions
- photocell for flame detection
- flame control panel, fitted with control function for the correct positioning of the servomotor and possibility of post-ventilation by just changing the electric wiring
- burner on/off switch
- flame inspection window
- manual or automatic output increase/decrease switch
- slide bars for easier installation and maintenance
- protection filter against radio interference
- IP 44 electric protection level.

Conforming to:

- 89/336/EC - 2004/108/EC directive (electromagnetic compatibility)
- 73/23/EC directive (low voltage)
- 92/42/EC directive (performance)
- 98/37/EC directive (machinery)
- EN 267 (liquid fuel burners).

**Standard equipment:**

- 2 flexible pipes for connection to the oil supply network
- 2 gaskets for the flexible pipes
- 2 nipples for connection to the pump
- 4 screws for fixing the burner flange to the boiler
- 1 thermal screen
- wiring loom fittings for electrical connections
- 2 slide bar extensions (for the extended head models and the RL 190/M model)
- instruction handbook for installation, use and maintenance
- spare parts catalogue.

Available accessories to be ordered separately:

- return nozzles
- extended head kit (except for the RL 190/M model)
- spacer kit
- sound-proofing box
- degasing unit
- head kit for "reverse flame chamber"
- connection flange kit
- RWF 40 output regulator
- temperature probe -100 – 500°C
- pressure probe 0 – 2.4 bar
- pressure probe 0 – 16 bar
- potentiometer kit for the servomotor.

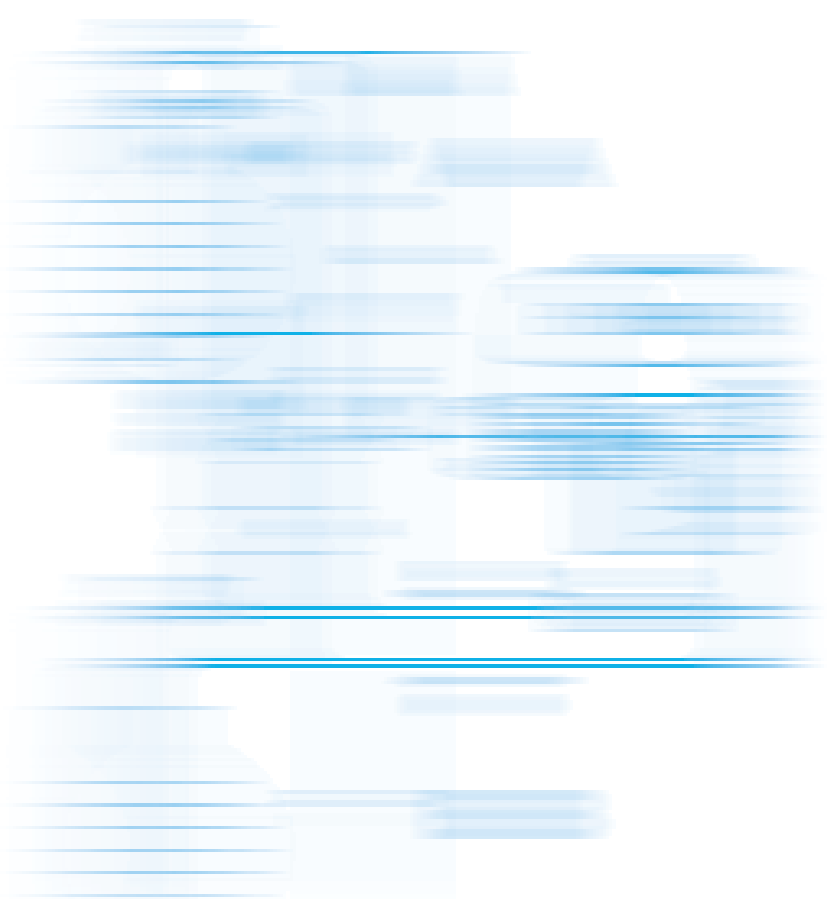



RIELLO S.p.A. - Via Ing. Pilade Riello, 5 - 37045 Legnago (VR) Italy
Tel. ++39.0442630111 - Fax ++39.044221980

Internet: <http://www.rielloburners.com> - E-mail: info@rielloburners.com

Since the Company is constantly engaged in the production improvement, the aesthetic and dimensional features, the technical data, the equipment and the accessories can be changed.
This document contains confidential and proprietary information of RIELLO S.p.A.
Unless authorised, this information shall not be divulged, nor duplicated in whole or in part.