

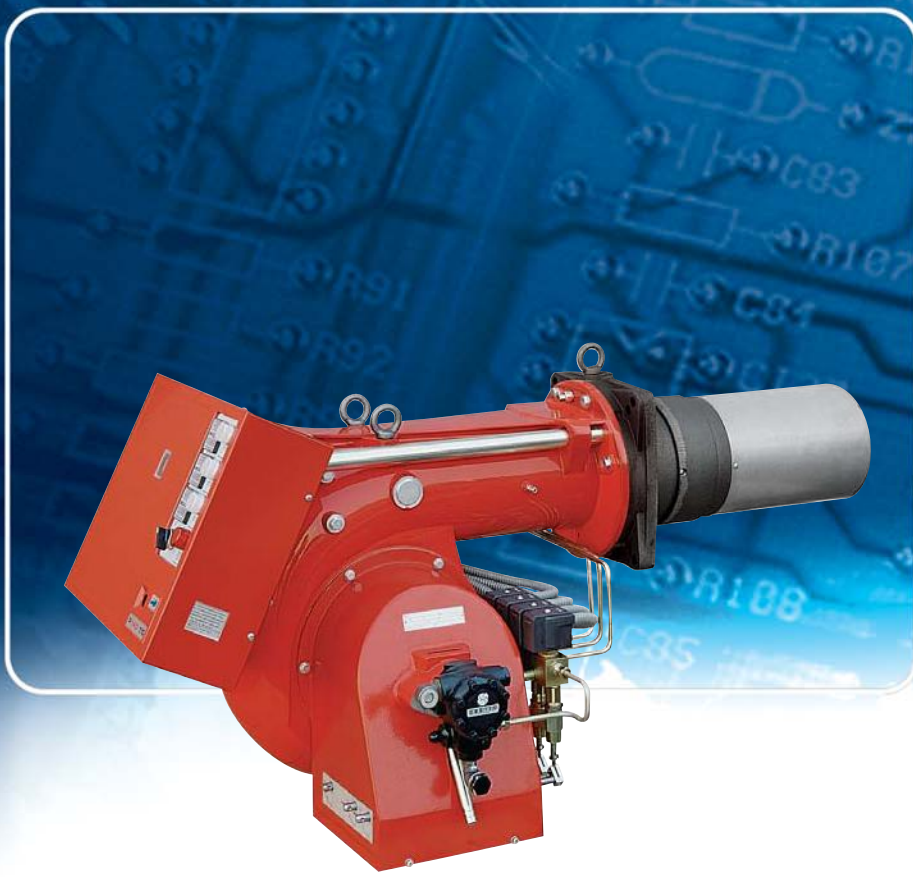

THREE STAGE LIGHT OIL BURNERS

▶ PRESS T/G SERIES	▶ P 140T/G	380/830 ÷ 1660 kW
	▶ P 200T/G	557/1186 ÷ 2372 kW
	▶ P 300T/G	712/1779 ÷ 3560 kW
	▶ P 450T/G	890/2670 ÷ 5340 kW



The PRESS T/G series of burners covers a firing range from 830 to 5340 kW. Available in 4 different models, this burners are particularly well suited for matching with pressurized chamber boilers. For their characteristics, they find application in big civil plants for domestic heating or in industrial applications where thermal load is repetitive and predictable. An hydraulic ram exclusive system, with 3 adjustable positions, regulates dampers opening, allowing air passage in relation to output required: in this way flame stability is optimized in every working point, with micro-regulation available. The burners are fitted with a microprocessor control panel which supplies indication of operation and diagnosis of fault cause.

TECHNICAL DATA

Model		▼ P 140 T/G	▼ P 200 T/G	▼ P 300 T/G	▼ P 450 T/G
Burner operation mode		Three stage			
Modulation ratio at max. output		3 : 1			
Servomotor	run time	s			
	type	--			
Heat output	kW	380/830±1660	557/1186±2372	712/1779±3560	890/2670±5340
	Mcal/h	327/714±1428	479/1020±2040	612/1530±3062	765/2296±4592
	kg/h	32/70±140	47/100±200	60/150±300	75/225±450
Working temperature		°C min./max. 0/40			
Net calorific value	kWh/kg	11,86			
	kcal/kg	10200			
Viscosity		mm ² /s (cSt) 4 ÷ 6 (at 20°C)			
Pump	type	J7	J7	TA2	TA3
	delivery	kg/h 190 (20 bar)	190 (20 bar)	340 (20 bar)	525 (20 bar)
Atomised pressure		bar 12			
Fuel temperature		max. °C 50			
Fuel pre-heater		NO			
Fan		type Centrifugal with forward curve blades			
Air temperature		max. °C 60			
Electrical supply		Ph/Hz/V 3N/50/400~(±10%) 3/50/230~(±10%) △			
Auxiliary electrical supply		Ph/Hz/V 1/50/230 (±10%)			
Control box		type RMO			
Total electrical power		kW 4,5	5,5	10	18
Auxiliary electrical power		kW 1,5	1,5	2,5	3
Heaters electrical power		kW --			
Protection level		IP 40			
Pump motor electrical power		kW --			
Rated pump motor current		A --			
Pump motor start up current		A --			
Pump motor protection level		IP --			
Fan motor electrical power		kW 3	4	7,5	15
Rated fan motor current		A 8/13,5	9,5/16,4	17,5/30	29/50,2
Fan motor start up current		A 51/86	48/83	113/195	167/291
Fan motor protection level		IP 55			
Ignition transformer		type V1 - V2 230 V - 2x6 kV			
		I1 - I2 2,3 A - 35 mA			
Operation		Intermittent (at least one stop every 24 h)			
Sound pressure		dBA 86,5	85,5	89,5	90
Sound power		W --			
CO emission		mg/kWh < 70			
Grade of smoke indicator		N° Bacharach < 2			
CxHy emission		mg/kWh --			
NOx emission		mg/kWh < 230			
Directive		89/336 (2004/108) - 73/23 (2006/95)			89/336 (2004/108)
Conforming to		- 92/42 - 98/37 EC			- 73/23 (2006/95) - 98/37 EC
Certification		EN 267			
Approval		DIN 5G455/2000	DIN 5G456/2000	DIN 5G457/2000	--

Reference conditions:

Temperature: 20°C

Pressure: 1013,5 mbar

Altitude: 0 m a.s.l.

Noise measured at a distance of 1 meter.

Since the Company is constantly engaged in the production improvement, the aesthetic and dimensional features, the technical data, the equipment and the accessories can be changed.

This document contains confidential and proprietary information of RIELLO S.p.A. Unless authorised, this information shall not be divulged, nor duplicated in whole or in part.



FIRING RATES

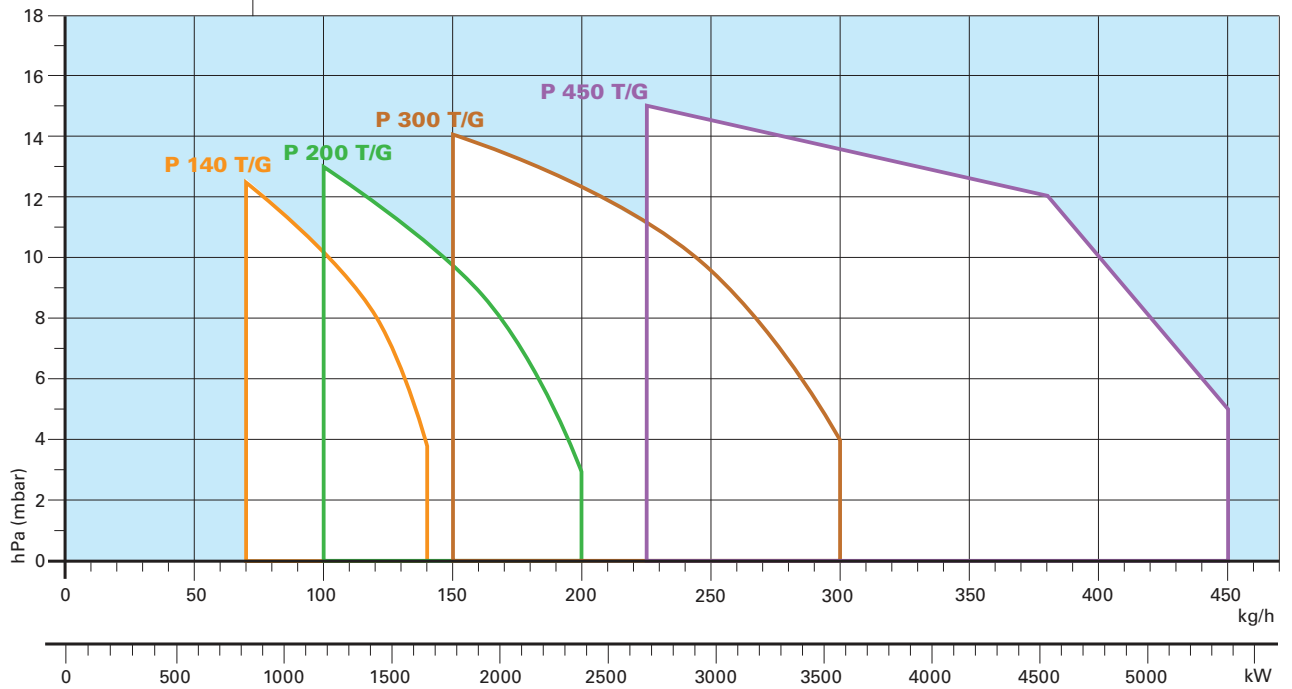

Useful working field for choosing the burner

Test conditions conforming to EN 267:

Temperature: 20°C
 Pressure: 1013,5 mbar
 Altitude: 0 m a.s.l.





FUEL SUPPLY

► HYDRAULIC CIRCUIT

The burners are fitted with four valves (a safety valve and three oil delivery valves) and an oil filter along the oil line from the pump to the nozzle.

A thermostat, on the basis of required heat, regulates oil delivery valves opening, allowing or not the light oil passage through the valves. Delivery valves opening supplies the three stage hydraulic ram which regulates air delivery in relation to fuel burnt.

The pumping group is fitted with a pump, an oil filter and a regulating valve, that adjusts atomised pressure. This value is factory-set at 12 bar but it can be changed by adjusting pressure regulator fitted on the pump.



Example of the hydraulic circuit on PRESS 200 T/G

EN 267 > 100 Kg/h

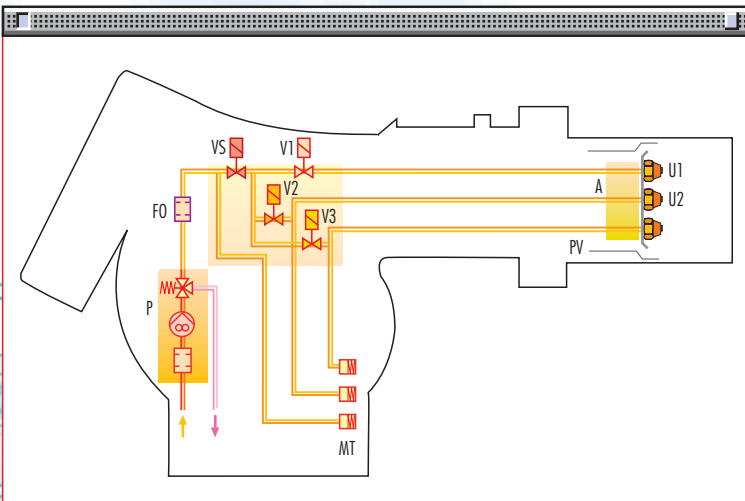

P	Pump with oil filter and pressure regulator
FO	Oil filter
V1 - V2 - V3	Delivery oil valves
VS	Safety valve
MT	3 stage hydraulic ram
U1 - U2 - U3	Nozzles
PV	Nozzle holder
A	Atomizer



DIMENSIONING OF THE FUEL SUPPLY LINES

The fuel feed must be completed with the safety devices required by the local norms.

The table shows the choice of piping diameter for the various burners, depending on the difference in height between the burner and the tank and their distance.

MAXIMUM EQUIVALENT LENGTH FOR THE PIPING L[m]								
Model	▼ P 140T/G		▼ P 200T/G		▼ P 300T/G		▼ P 450T/G	
Diameter piping	Ø14mm	Ø16mm	Ø16mm	Ø18mm	Ø16mm	Ø18mm	Ø16mm	Ø18mm
+H, -H (m)	L _{max} (m)	L _{max} (m)	L _{max} (m)	L _{max} (m)	L _{max} (m)	L _{max} (m)	L _{max} (m)	L _{max} (m)
+2,0	71	118	84	132	57	90	40	60
+1,5	66	110	78	123	53	83	35	55
+1,0	61	102	72	114	49	77	32	50
+0,5	55	94	66	105	44	70	30	48
0	50	86	60	96	40	64	27	43
-0,5	45	78	54	87	36	58	18	35
-1,0	40	69	48	78	31	51	15	30
-1,5	35	61	42	69	27	45	13	25
-2,0	29	53	36	60	23	39	10	20
-3,0	20	38	25	43	15	27	5	10

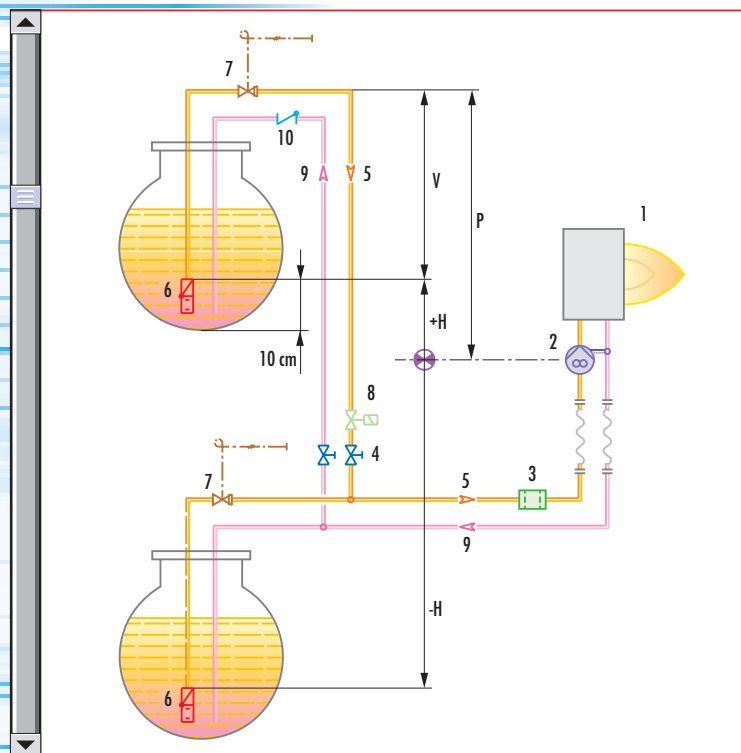

H	Difference in height pump-foot valve
Ø	Internal pipe diameter
P	Max. height 10 m
V	Height 4 m
1	Burner
2	Burner pump
3	Filter
4	Manual shut off valve
5	Suction pipework
6	Bottom valve
7	Remote controlled rapid manual shut off valve (compulsory in Italy)
8	Type approved shut off solenoid valve (compulsory in Italy)
9	Return pipework
10	Check valve

note With ring distribution oil systems, the feasible drawings and dimensioning are the responsibility of specialised engineering studios, who must check compatibility with the requirements and features of each single installation.



VENTILATION

The ventilation circuit is provided with forward curve blades centrifugal fan, which guarantees high pressure levels at the required air deliveries and permits installation flexibility. In spite of the remarkable output power and of the very high pressure performances, structures of PRESS models are extremely compact. A variable profile cam connects fuel and air setting, ensuring fuel efficiency in all firing rates.

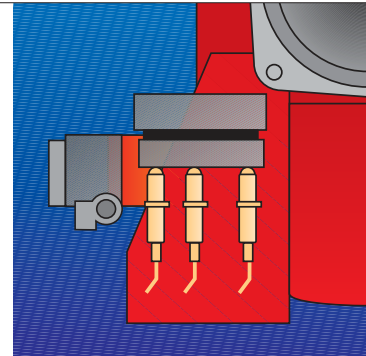

Example of three stage hydraulic ram

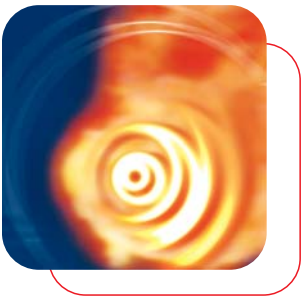

COMBUSTION HEAD

Two different lengths of the combustion head can be chosen for the various models of the PRESS T/G series of burners. The choice depends on the thickness of the front panel and the type of the boiler. Depending on the type of heat generator, it is necessary to check the correct head penetration into the combustion chamber. The internal position of the combustion head can easily be adjusted on the basis of required output. flame dimensions in relation to the burner output. The length and diameter shown in the diagram below should be employed preliminary check: it is required a more careful investigation if combustion chamber dimensions are much different from the reported values.

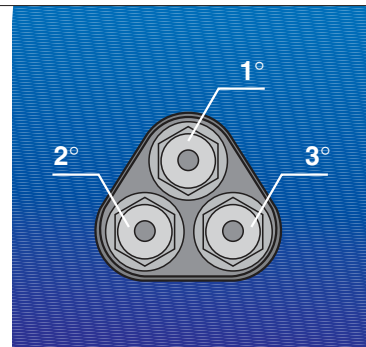

Example of a PRESS T/G burner combustion head

Flame dimensions

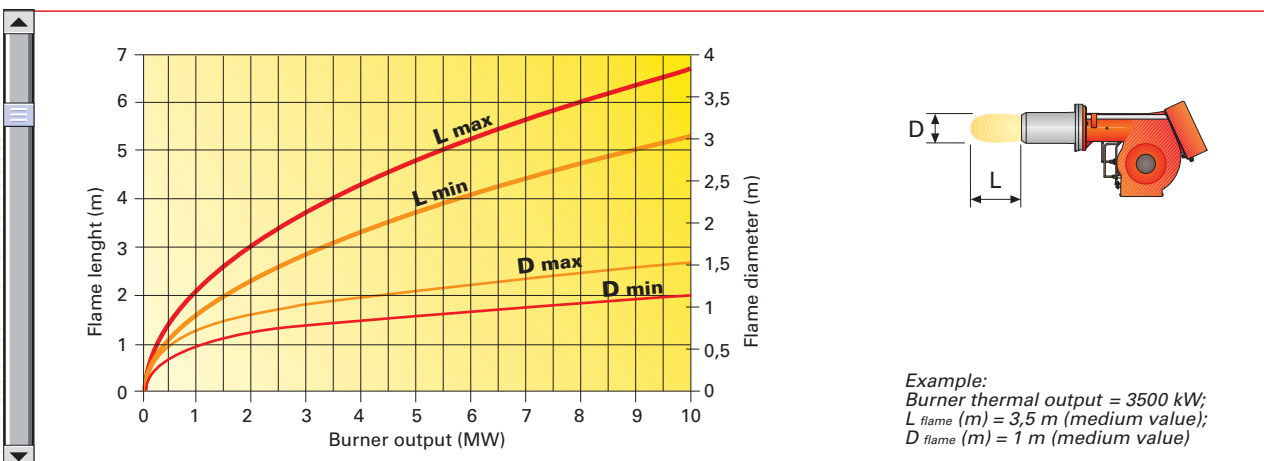

OPERATION



BURNER OPERATION MODE

With three stage operation, the PRESS T/G burners can follow the temperature load requested by the system.

A ratio between maximum and minimum working output of 3:1 is reached, thank to a three-hydraulic ram system: the air delivery is proportional to required output.

On three stage operation, the burner gradually adjusts output to the requested level, by varying between the three pre-set levels (see picture A).

Three stage operation

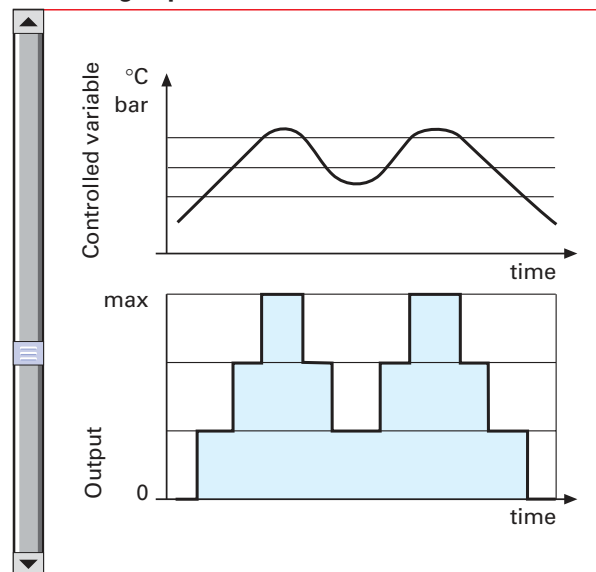

Picture A

In the following table, are listed maximum output and fuel deliveries of the burners.

Model	Stage	Max output (kW)	Max delivery (kg/h)
▶ P 140T/G	1 st	545	46
	2 nd	1103	93
	3 rd	1660	140
▶ P 200T/G	1 st	794	67
	2 nd	1576	133
	3 rd	2372	200
▶ P 300T/G	1 st	1186	100
	2 nd	2372	200
	3 rd	3558	300
▶ P 450T/G	1 st	1780	150
	2 nd	3560	300
	3 rd	5340	450



All PRESST/G series burners are fitted with a new microprocessor control panel for the supervision during intermittent operation.
For helping the commissioning and maintenance work, there are two main elements:



The lock-out reset button is the central **operating element** for resetting the burner control and for activating / deactivating the diagnostic functions.



The multi-color LED is the central **indication element** for visual diagnosis and interface diagnosis.

Both elements are located under the transparent cover of lock-out reset button, as showed below.

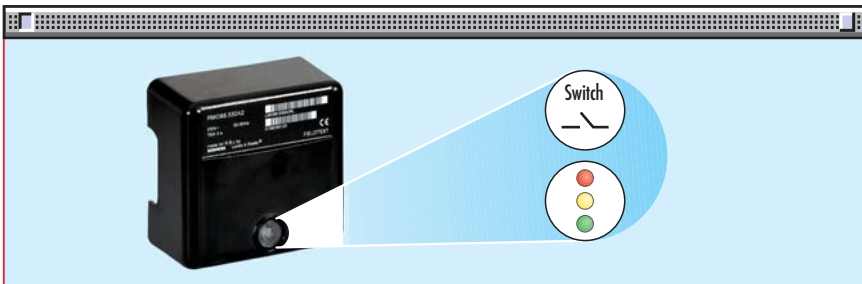

There are two diagnostic choices, for indication of operation and diagnosis of fault cause:

- visual diagnosis :

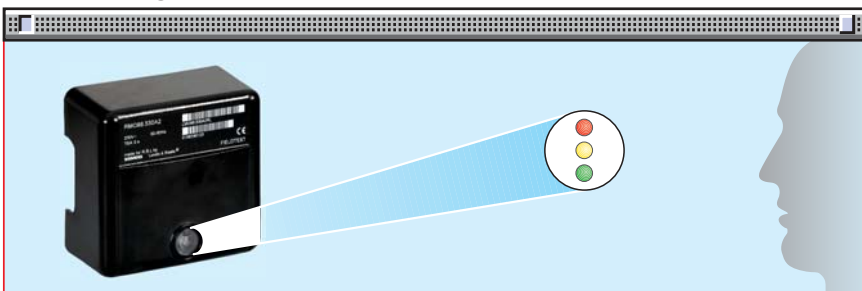

- interface diagnosis :



by the interface adapter and a PC with dedicated software or by a predisposed flue gas analyzer (see paragraph accessories).



Indication of operation :

In normal operation, the various status are indicated in the form of colour codes according to the table below.

The interface diagnosis (with adapter) can be activated by pressing the lock-out button for > 3 seconds.

Color code table	
Operation status	Color code table
Stand-by	○ ○ ○ ○ ○ ○ ○ ○
Pre-purging	☀ ☀ ☀ ☀ ☀ ☀ ☀ ☀
Ignition phase	☀ ○ ☀ ○ ☀ ○ ☀ ○
Flame OK	🟢 🟢 🟢 🟢 🟢 🟢 🟢 🟢
Poor flame	🟢 ○ 🟢 ○ 🟢 ○ 🟢 ○
Undervoltage, built-in fuse	☀ 🟡 ☀ 🟡 ☀ 🟡 ☀ 🟡
Fault, alarm	🔴 🔴 🔴 🔴 🔴 🔴 🔴 🔴
Extraneous light	🔴 🟢 🔴 🟢 🔴 🟢 🔴 🟢

○ LED off

Diagnosis of fault causes :

After lock-out has occurred, the red signal lamp is steady on. In this status, the visual fault diagnosis according to the error code table can be activated by pressing the lock-out reset button for > 3 seconds. The interface diagnosis (with adapter) can be activated by pressing again the lock-out button for > 3 seconds.

The flashes of red LED are a signal with this sequence :

(e.g. signal with n° 3 flashes – faulty air pressure monitor)



Error code table	
Possible cause of fault	Flash code
No establishment of flame at the end of safety time : - faulty or soiled fuel valves - faulty or soiled flame detector - poor adjustment of burner, no fuel - faulty ignition equipment	2 flashes 🔴 🔴
Faulty air pressure monitor	3 flashes 🔴 🔴 🔴
Extraneous light or simulation of flame on burner start up	4 flashes 🔴 🔴 🔴 🔴
Loss of flame during operation : - faulty or soiled fuel valves - faulty or soiled flame detector - poor adjustment of burner	7 flashes 🔴 🔴 🔴 🔴 🔴 🔴 🔴
Wiring error or internal fault	10 flashes 🔴 🔴 🔴 🔴 🔴 🔴 🔴 🔴 🔴 🔴

START UP CYCLE

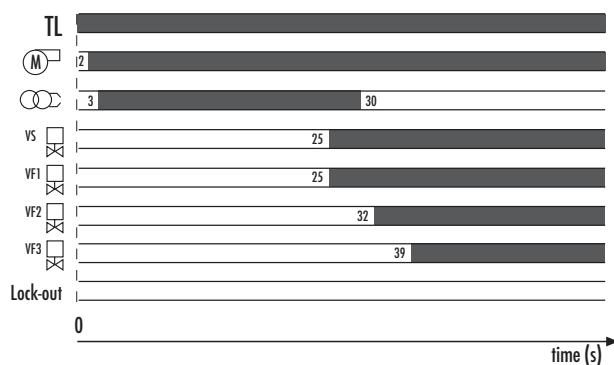

Start up procedure is referred to a three stage operation

- 0s The burner begins the firing cycle.
- 2s The motor starts: pre-purge phase.
- 3s Ignition electrode sparks.
- 25s Safety valve VS and 1st stage valve VF1 open.
- 30s The spark goes out.
- 32s 2nd stage valve VF2 opens.
- 39s 3rd stage valve VF3 opens, start up cycle is concluded.



WIRING DIAGRAMS



Electrical connections must be made by qualified and skilled personnel, according to the local norms.

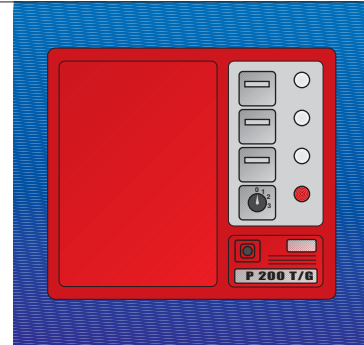

Example of control panel for P 200 T/G models

“THREE STAGE” OPERATION

Direct start-up version P 140-200-300 T/G

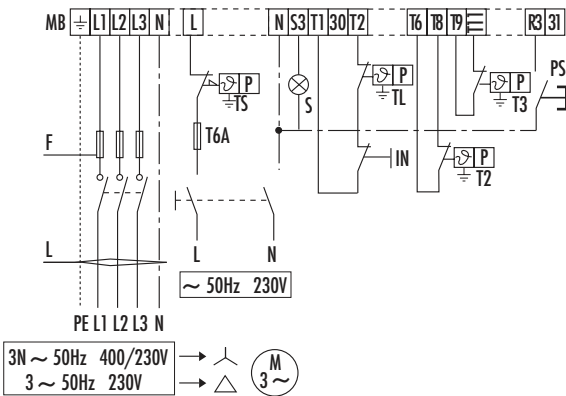

- MB** - Burner terminal board
- TS** - Safety thermostat
- S** - External lock-out signal
- IN** - Manual switch
- TL** - Threshold thermostat
- T2** - 2nd stage thermostat
- T3** - 3rd stage thermostat
- T6A** - 6A fuse
- F** - Fuse (see table A)
- L** - Lead section (see table A)
- PS** - Lock out reset button

Star delta start-up version P 300-450 T/G

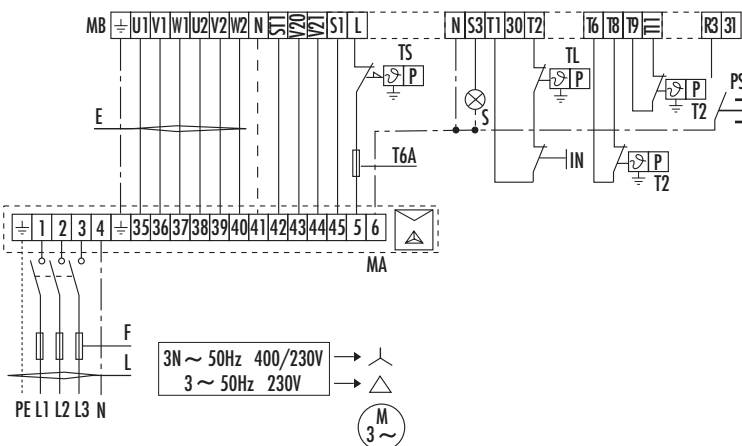

- MB** - Burner terminal board
- TS** - Safety thermostat
- S** - External lock-out signal
- IN** - Manual switch
- TL** - Threshold thermostat
- MA** - Star-delta starter terminal strip
- T2** - 2nd stage thermostat
- T3** - 3rd stage thermostat
- T6A** - 6A fuse
- F** - Fuse (see table A)
- L** - Lead section (see table A)
- PS** - Lock out reset button

The following table shows the supply lead sections and the type of fuse to be used.

Model	Direct				Star delta					
	▼ P 140 T/G		▼ P 200 T/G		▼ P 300 T/G		▼ P 300 T/G		▼ P 450 T/G	
F (A)	230V	400V	230V	400V	230V	400V	230V	400V	230V	400V
L (mm ²)	T25	T25	T35	T25	T63	T50	T50	T35	T63	T50
L (mm ²)	2,5	2,5	4	2,5	6	4	6	4	10	6
E (mm ²)	-	-	-	-	-	-	4	2,5	6	4

Table A

EMISSIONS

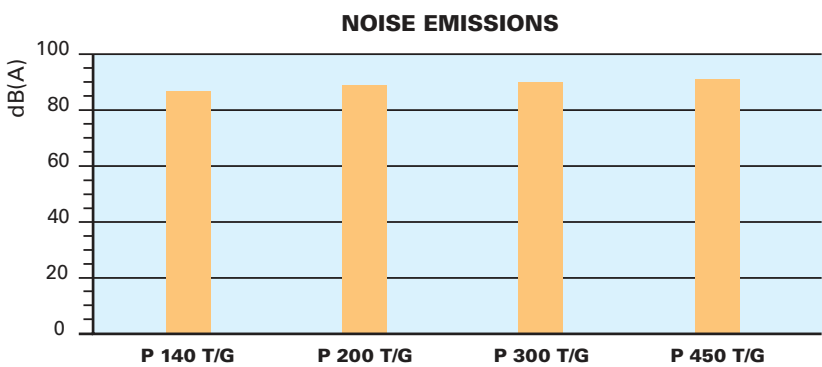
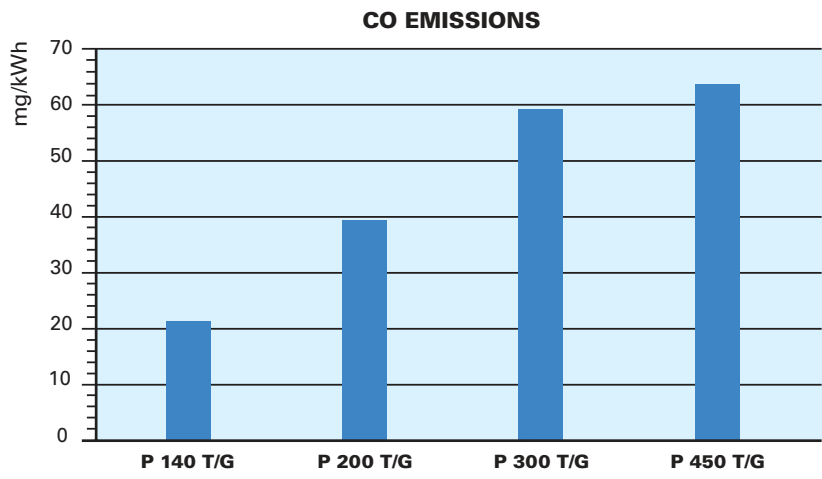
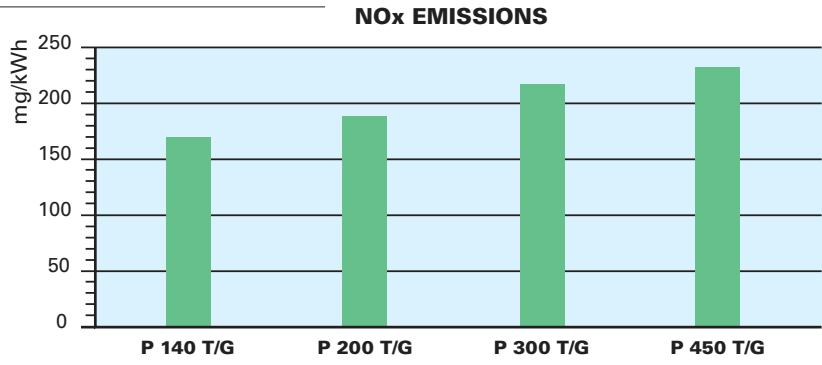

The emission data has been measured in the various models at maximum output, according to EN 267 standard.



OVERALL DIMENSIONS (mm)

BURNER

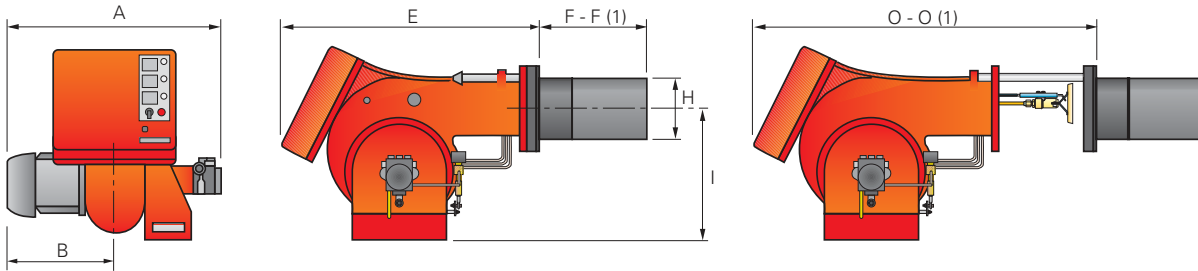

Model	A	B	E	F - F (1)	H	I	O - O (1)
▶ P 140T/G	765	365	890	363 - 473	222	467	1250 - 1360
▶ P 200T/G	796	396	890	391 - 501	250	467	1280 - 1390
▶ P 300T/G	858	447	1000	444 - 574	295	496	1440 - 1570
▶ P 450T/G	950	508	1070	476 - 606	336	525	1546 - 1676

(1) Length with extended combustion head.

BURNER - BOILER MOUNTING FLANGE

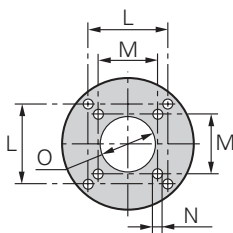

Model	L	M	N Ø	O
▶ P 140T/G	260	230	M14	225
▶ P 200T/G	260	-	M16	255
▶ P 300T/G	260	-	M18	300
▶ P 450T/G	310	-	M20	340

PACKAGING

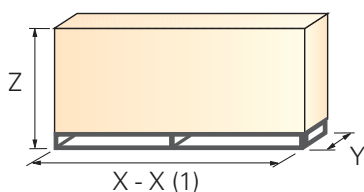

Model	X - X (1)	Y	Z	kg
▶ P 140T/G	1500	930	905	130
▶ P 200T/G	1500	930	905	220
▶ P 300T/G	1780	1085	990	238
▶ P 450T/G	1780	1085	990	300

(1) Length with extended combustion head.

INSTALLATION DESCRIPTION

Installation, start-up and maintenance must be carried out by qualified and skilled personnel.
All operations must be performed in accordance with the technical handbook supplied to the burner.



BURNER SETTING

- ▶ All the burners have slide bars, for easier installation and maintenance.
- ▶ After removing the cover, the split pin and the pin, the nuts and the screws, dismantle the blast tube from the burner and fix it to the boiler.
- ▶ Adjust the combustion head.
- ▶ Refit the burner casing to the slide bars.
- ▶ Install the nozzles, choosing it on the basis of the maximum boiler output and following the diagrams included in the burner instruction handbook.
- ▶ Check the position of the electrodes.
- ▶ Close the burner, fasten the screws, the nuts, the split pin and the pin.

HYDRAULIC AND ELECTRICAL CONNECTIONS AND START-UP

- ▶ The burners are supplied for connection to two pipes fuel supply system.
- ▶ Connect the ends of the flexible pipes to the suction and return pipework using the supplied nipples.
- ▶ Make the electrical connections to the burner following the wiring diagrams included in the instruction handbook.
- ▶ Prime the pump by turning the motor (after checking rotation direction).
- ▶ On start up, check:
 - Pressure pump and valve unit regulator (to max. and min.)
 - Combustion quality, in terms of unburned substances and excess air.



BURNER ACCESSORIES

Nozzles

The nozzles are part of the standard equipment. The following table shows the features and codes on the basis of the required output. For the choice of the three related nozzles, refer to the burner handbook.



Nozzle type 60° B					
Burner	GPH	Rated output (kg/h)			Nozzle code
		at 10 bar	at 12 bar	at 14 bar	
P 140 T/G	3,50	13,5	14,8	16,1	3042162
P 140 T/G	4,00	15,4	17	18,4	3042172
P 140 T/G	4,50	17,3	19,1	20,7	3042182
P 140 T/G - P 200 T/G	5,00	19,2	21,2	23	3042192
P 140 T/G - P 200 T/G	5,50	21,1	23,3	25,3	3042202
P 140 T/G - P 200 T/G	6,00	23,1	25,5	27,7	3042212
P 140 T/G - P 200 T/G	6,50	25	27,6	30	3042222
P 140 T/G - P 200 T/G	7,00	26,9	29,7	32,3	3042232
P 140 T/G - P 200 T/G	7,50	28,8	31,8	34,6	3042242
P 140 T/G - P 200 T/G	8,00	30,8	33,9	36,9	3042252
P 140 T/G - P 200 T/G	8,50	32,7	36,1	39,2	3042262
P 140 T/G - P 200 T/G	9,50	36,5	40,3	43,8	3042282
P 140 T/G - P 200 T/G	10,00	38,4	42,4	46,1	3042292
P 140 T/G - P 200 T/G	11,00	42,3	46,7	50,7	3042312
P 200 T/G	12,00	46,1	50,9	55,3	3042322
P 200 T/G	13,00	50	55,1	59,9	3042332
P 200 T/G - P 300 T/G	14,00	53,8	59,4	64,5	3042352
P 200 T/G - P 300 T/G	15,00	57,7	63,6	69,2	3042362
P 300 T/G	16,00	61,5	67,9	73,8	3042382
P 300 T/G	17,00	65,4	72,1	78,4	3042392
P 300 T/G - P 400 T/G	18,00	69,2	76,4	83	3042412
P 300 T/G - P 400 T/G	19,00	73	80,6	87,6	3042422
P 300 T/G - P 400 T/G	20,00	76,9	84,8	92,2	3042442
P 300 T/G - P 400 T/G	22,00	84,6	93,3	101,4	3042462
P 300 T/G - P 400 T/G	24,00	92,2	101,8	110,6	3042472
P 450 T/G	26,00	99,9	110,3	119,9	3042482
P 450 T/G	28,00	107,6	118,8	129,1	3042492
P 450 T/G	30,00	110,4	122	132,4	3042502
P 450 T/G	32,00	117,8	130,1	150,1	3042512
P 450 T/G	35,00	128,8	142,1	154,5	3042522



Spacer kit

If burner head penetration in the combustion chamber needs reducing, varying thickness spacers are available, as given in the following table.

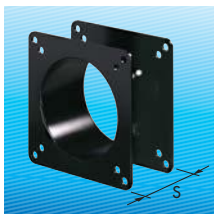

Spacer kit		
Burner	Spacer thickness S (mm)	Spacer code
P 140 T/G	110	3000722
P 200 T/G	110	3000722
P 300 T/G	130	3000723
P 450 T/G	130	3000751

Sound proofing box

If noise emissions need reducing, sound proofing hoods are available, as given in the following table.



Sound proofing box			
Burner	Box type	Average noise reduction [dB(A)] (*)	Box code
P 140 T/G - P 200 T/G	C4/5	10	3010404
P 300 T/G - P 450 T/G	C7	10	3010376

(*) according to EN 15036-1 standard

Burner support

For easier maintenance, a mobile burner support has been designed, which means the burner can be dismantled without the need of forklift trucks.

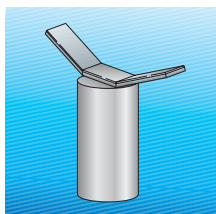

Burner support	
Burner	Support code
P 300 T/G - P 450 T/G	3000731

PC interface kit

To connect the flame control panel to a personal computer for the transmission of operation, fault signals and detailed service information, an interface adapter with PC software are available.



PC interface kit	
Burner	Kit code
P140-200-300-450 T/G	3002719



SPECIFICATION

A specific index guides your choice of burner from the various models available in the PRESS series. Below there is a clear and detailed specification description of the product.

DESIGNATION OF SERIES

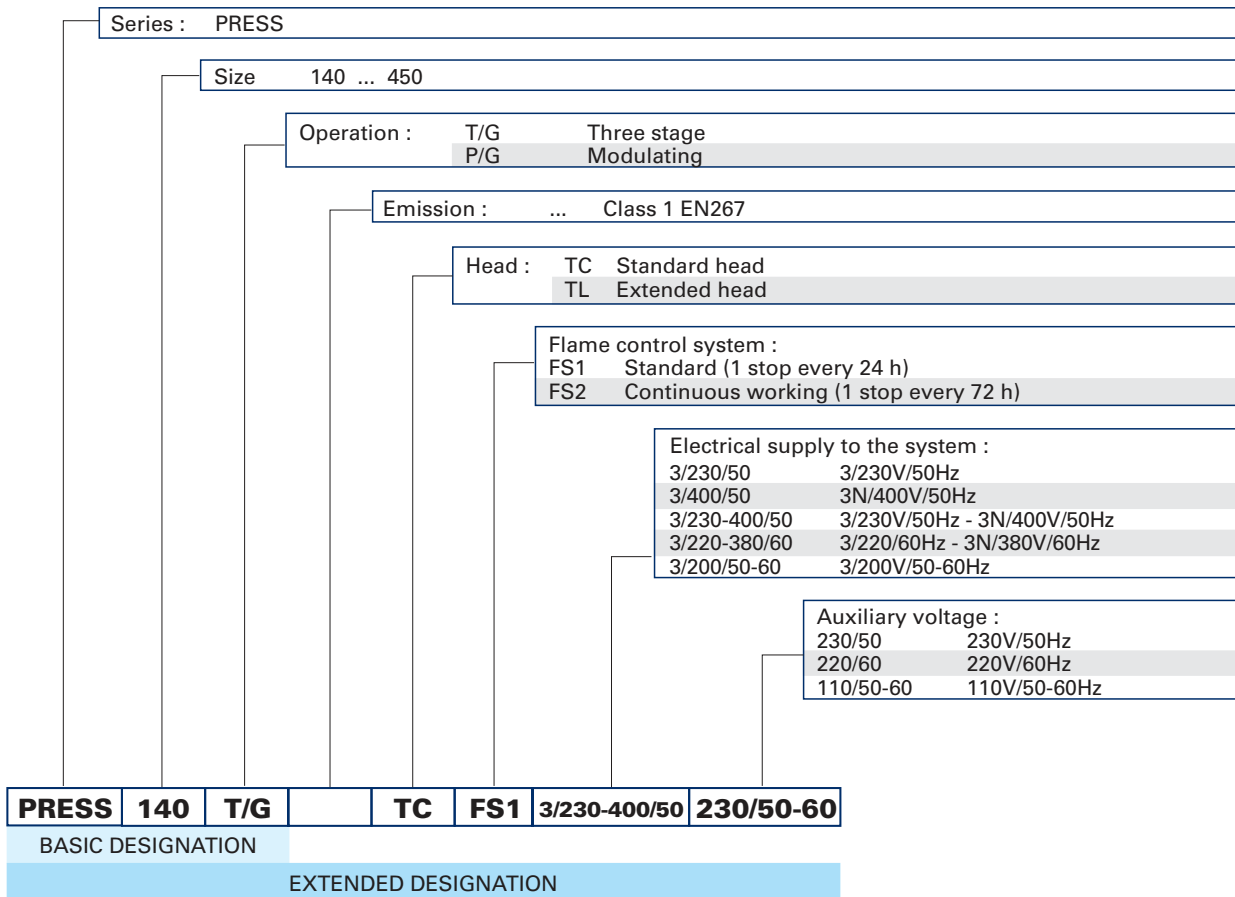

AVAILABLE BURNER MODELS

P 140	T/G	TC	3/230-400/50	230/50	P 300	T/G	TL	3/230/50	230/50
P 140	T/G	TL	3/230-400/50	230/50	P 300	T/G	TC	3/400/50	230/50
P 200	T/G	TC	3/230-400/50	230/50	P 300	T/G	TL	3/400/50	230/50
P 200	T/G	TL	3/230-400/50	230/50	P 450	T/G	TC	3/230/50	230/50
P 300	T/G	TC	3/230-400/50	230/50	P 450	T/G	TL	3/230/50	230/50
P 300	T/G	TL	3/230-400/50	230/50	P 450	T/G	TC	3/400/50	230/50
P 300	T/G	TC	3/230/50	230/50	P 450	T/G	TL	3/400/50	230/50

Other models are available on request.



▶ PRODUCT SPECIFICATION

Burner:

Monoblock forced draught oil burner with three stage operation, fully automatic, made up of:

- Air suction circuit lined with sound-proofing material
- Fan with forward curved blades high performance pressure levels
- Air dampers for air setting controlled by a three stage hydraulic ram
- Starting motor at 2850 rpm, three-phase 400 V with neutral, 50 Hz
- Combustion head, that can be set on the basis of the combustion output, fitted with:
 - stainless steel end cone, resistant to corrosion and high temperatures
 - ignition electrodes
 - flame stability disk
- Gears pump for high pressure fuel supply, fitted with:
 - filter
 - pressure regulator
 - connections for installing a pressure gauge and vacuumeter
 - internal by-pass for single pipe installation
- Valve unit with a oil safety valve and three oil delivery valves on the output circuit;
- Photocell for flame detection
- Microprocessor based flame control panel, with diagnostic function
- Burner on/off switch
- Flame inspection window
- Slide bars for easier installation and maintenance
- Protection filter against radio interference
- IP 40 electric protection level.

Conforming to:

- 89/336 (2004/108) EC directive (electromagnetic compatibility)
- 73/23 (2006/95) EC directive (low voltage)
- 92/42/EC directive (performance)
- 98/37/EC directive (machinery)
- EN 267 (liquid fuel burners).

Standard equipment:

- 2 flexible pipes for connection to the oil supply network
- 2 nipples for the connection to the pump
- 4 wiring looms fittings for electrical connections
- 4 screws for fixing the burner flange to the boiler
- Instruction handbook for installation, use and maintenance
- Spare parts catalogue
- 2 slide bar extensions (for the extended head models of P 300 T/G and P 450 T/G)
- 3 nozzles
- Gasket for flange
- Starter (*)
- Diffuser disk (P 450 T/G).

(*) *For versions with star-delta starting.*

Available accessories to be ordered separately:

- Nozzles
- Spacer kit
- Sound-proofing box
- Burner support
- PC interface kit.







RIELLO S.p.A. - Via Ing. Pilade Riello, 5 - 37045 Legnago (VR) Italy
Tel. ++39.0442630111 - Fax ++39.044221980

Internet: <http://www.rielloburners.com> - E-mail: info@rielloburners.com

Since the Company is constantly engaged in the production improvement, the aesthetic and dimensional features, the technical data, the equipment and the accessories can be changed.
This document contains confidential and proprietary information of RIELLO S.p.A.
Unless authorised, this information shall not be divulged, nor duplicated in whole or in part.