

**TWO STAGE LIGHT OIL BURNERS**

▶ **PRESS G SERIES**

▶ <b>PRESS GW</b>	107/178 ÷ 356 kW
▶ <b>PRESS 1G</b>	130/190 ÷ 534 kW
▶ <b>PRESS 2G</b>	214/356 ÷ 712 kW
▶ <b>PRESS 3G</b>	273/534 ÷ 1168 kW
▶ <b>PRESS 4G</b>	415/830 ÷ 1660 kW

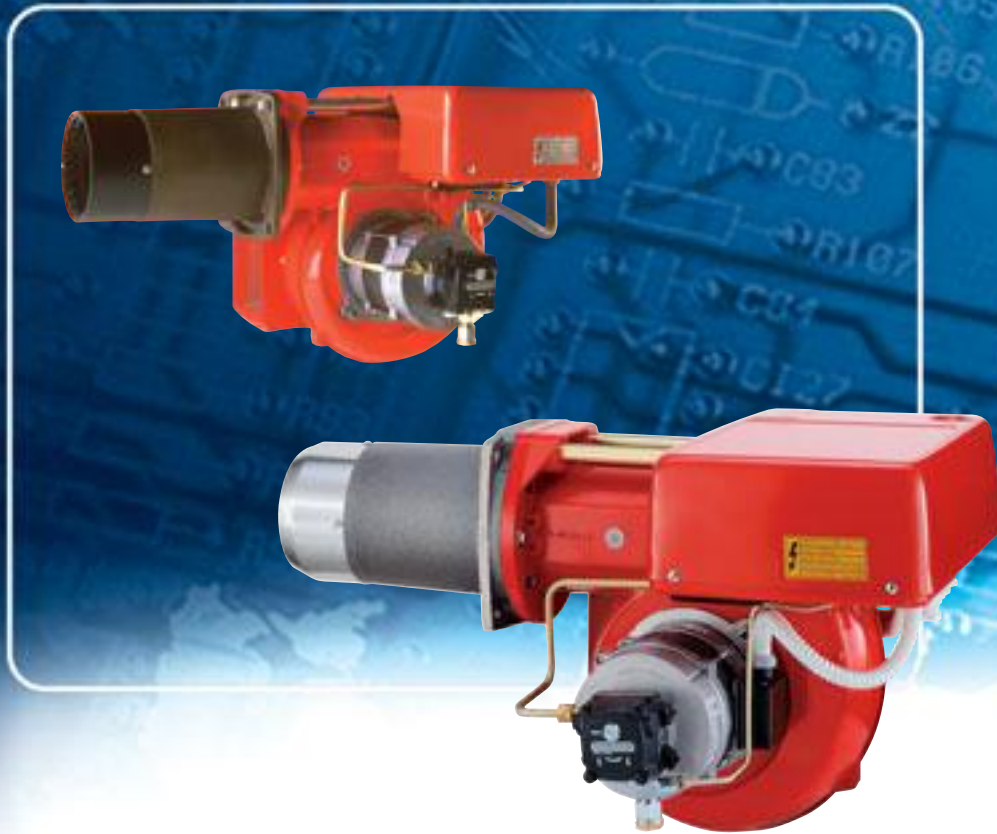

The PRESS G series of burners covers a firing range from 107 to 1660 kW and they have been designed for use in civil installations of average dimensions, like building areas and large apartment groups or for use in industrial applications, like small or medium plants. Operation is two stage; the combustion head, that can be set on the basis of required output, allows optimal performance ensuring good combustion and reducing fuel consumption. The main feature of these burners is their reliability due to a simple and strong construction, that permits operation without particular maintenance intervention. Simplified maintenance is achieved by the slide bar system, which allows easy access to all of the essential components of the combustion head. All electrical components are easily accessible only by dismounting a protection panel, thus guaranteeing a quick and simple intervention on components.



# TECHNICAL DATA

Model		▼ PRESS GW	▼ PRESS 1G	▼ PRESS 2G	▼ PRESS 3G	▼ PRESS 4G
Bumer operation mode		Two stage				
Modulation ratio at max. output		2 ÷ 1				
Servomotor	type	--				
	run time	s				
Heat output	kW	107/178÷356	130/190÷534	214/356÷712	273/534÷1168	415/830÷1660
	Mcal/h	92/153÷306	112/163÷459	184/306÷612	235/459÷1004	357/714÷1428
	kg/h	9/15÷30	11/16÷45	18/30÷60	23/45÷100	35/70÷140
Working temperature		°C min./max. 0/40				
Net calorific value		kWh/kg 11,8				
		kcal/kg 10200				
Viscosity		mm <sup>2</sup> /s (cSt) 4 ÷ 6 (at 20°C)				
Pump	type	AN 67	AN 77	AN 77	J 6	J 7
	delivery	kg/h 65 (12 bar)	90 (12 bar)	90 (12 bar)	164 (12 bar)	244 (12 bar)
Atomised pressure		bar 12				
Fuel temperature		Max. °C 50				
Fuel pre-heater		NO				
Fan		type Centrifugal with forward curve blades				
Air temperature		Max. °C 60				
Electrical supply		Ph/Hz/V 1/50/230~(±10%)	3N/50/400~(±10%)			3/50/230~(±10%) △
Auxiliary electrical supply		Ph/Hz/V 1/50/230~(±10%)				
Control box		type RMO				
Total electrical power		kW 0,43	0,6	1,07	2,05	3,8
Auxiliary electrical power		kW 0,18	0,15	0,3	0,5	0,8
Protection level		IP 40				
Pump motor electrical power		kW --				
Rated pump motor current		A --				
Pump motor start up current		A --				
Pump motor protection level		IP --				
Fan motor electrical power		kW 0,25	0,45	0,75	1,5	3
Rated fan motor current		A 2,1	1,9 - 1,1	2,9 - 1,7	6 - 3,5	10,5 - 6
Fan motor start up current		A 4,8	9,5 - 5,5	14 - 8	28 - 16	55 - 32
Fan motor protection level		IP 54				
Ignition transformer		type --				
		V1 - V2 230 V - 8 kV				
		I1 - I2 1,8 A - 30 mA				
Operation		Intermittent (at least one stop every 24 h)				
Sound pressure		dBA 75,5	78	81,5	83	85
Sound power		W --				
CO emission		mg/kWh < 110				
Grade of smoke indicator		N° Bach. < 1				
C <sub>x</sub> H <sub>y</sub> emission		mg/kWh < 10 (after the first 20 s)				
NO <sub>x</sub> emission		mg/kWh < 250				
Directive		73/23 - 89/336 - 98/37 - 92/42 EEC				
Conforming to		EN 267				
Certification		--				

## Reference conditions:

Temperature: 20°C

Pressure: 1013.5 mbar

Altitude: 100 m a.s.l.

Noise measured at a distance of 1 meter.

Since the Company is constantly engaged in the production improvement, the aesthetic and dimensional features, the technical data, the equipment and the accessories can be changed.  
This document contains confidential and proprietary information of RIELLO S.p.A. Unless authorised, this information shall not be divulged, nor duplicated in whole or in part.



# FIRING RATES

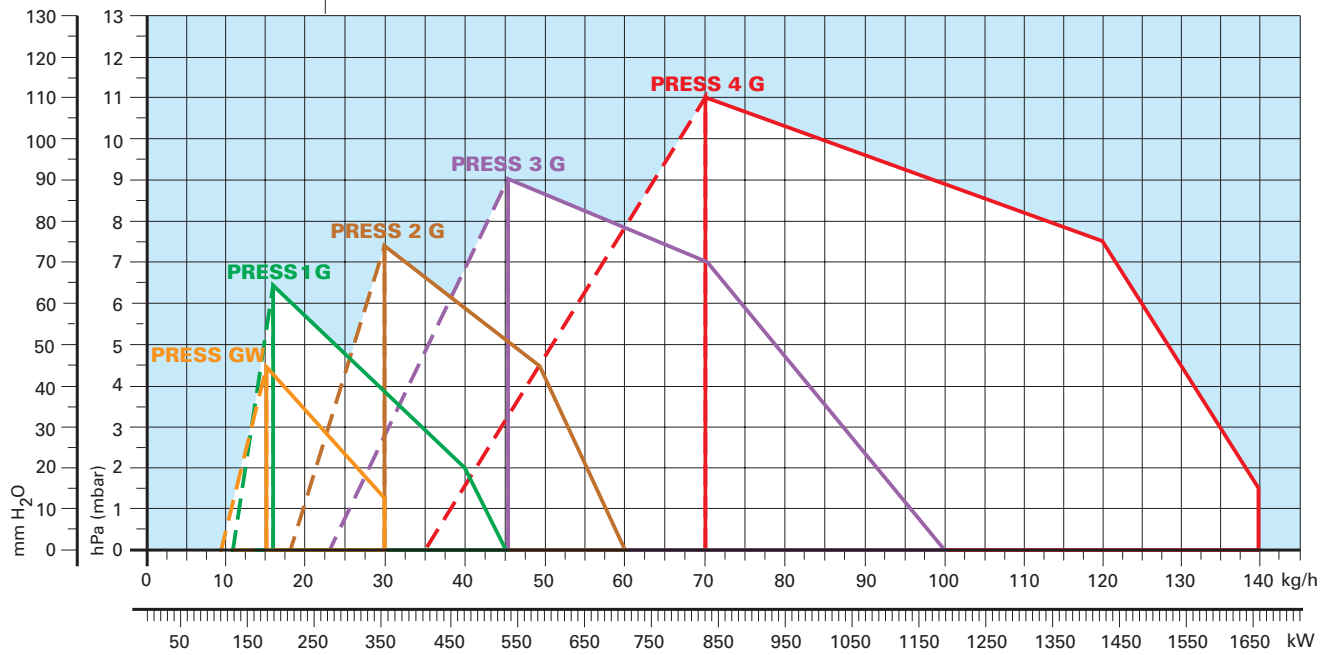

Useful working field for choosing the burner

1<sup>st</sup> stage operating rate

**Test conditions conforming to EN 267:**

Temperature: 20°C  
 Pressure: 1013.5 mbar  
 Altitude: 100 m a.s.l.



# FUEL SUPPLY

## HYDRAULIC CIRCUITS

The burners are fitted with two oil delivery valves. A control device, on the basis of required output, regulates oil delivery valves opening, allowing light oil passage through the valves and the nozzles. 2nd stage delivery valve opening supplies the hydraulic ram which opens the air damper in relation to the fuel burnt on 2nd stage. All burners are fitted with a self-priming pump with filter and pressure regulator.



Example of self-priming pump of PRESS G burners

### PRESS GW - 1G - 2G

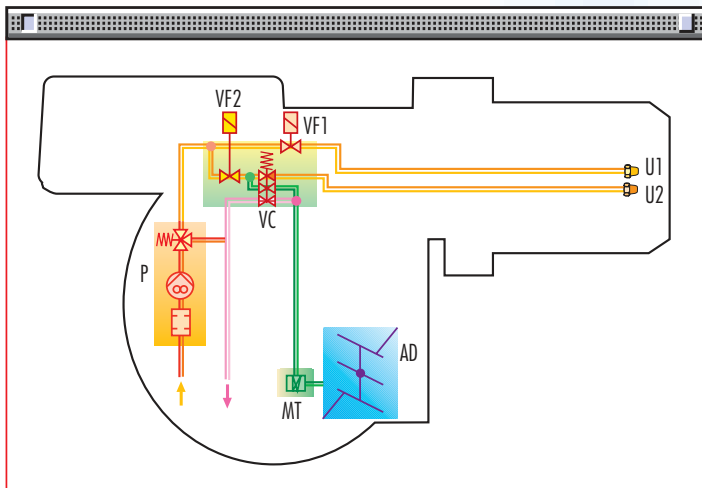

### PRESS 3G - 4G

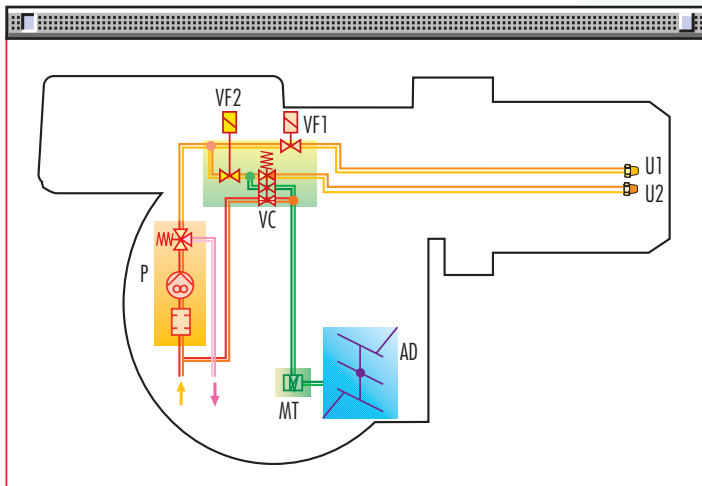

P	Pump with filter and pressure regulator on the output circuit
VF1	1st stage valve
VF2	2nd stage valve
VC	2nd stage control device
MT	Hydraulic ram
AD	Air damper
U1	1st stage nozzle
U2	2nd stage nozzle



## SELECTING THE FUEL SUPPLY LINES

The fuel feed must be completed with the safety devices required by the local norms.

The table shows the choice of piping diameter for the various burners, depending on the difference in height between the burner and the tank and their distance.

MAXIMUM EQUIVALENT LENGTH FOR THE PIPING L[m]												
Model	▼ PRESS GW			▼ PRESS 1G - 2G			▼ PRESS 3G			▼ PRESS 4G		
Ø piping	Ø8mm	Ø10mm	Ø12mm	Ø10mm	Ø12mm	Ø14mm	Ø12mm	Ø14mm	Ø16mm	Ø12mm	Ø14mm	Ø16mm
+H, -H (m)	L <sub>max</sub> (m)	L <sub>max</sub> (m)	L <sub>max</sub> (m)	L <sub>max</sub> (m)	L <sub>max</sub> (m)	L <sub>max</sub> (m)	L <sub>max</sub> (m)	L <sub>max</sub> (m)	L <sub>max</sub> (m)	L <sub>max</sub> (m)	L <sub>max</sub> (m)	L <sub>max</sub> (m)
+4,0	35	90	152	63	144	150	71	139	151	44	88	158
+3,0	30	80	152	55	127	150	62	123	151	38	77	140
+2,0	26	69	152	48	111	150	53	106	151	33	66	121
+1,0	21	59	130	40	94	150	45	90	151	27	56	103
+0,5	19	53	119	37	86	150	40	82	151	24	50	94
0	17	48	108	33	78	150	36	74	137	21	45	85
-0,5	15	43	97	29	70	133	32	66	123	18	40	76
-1,0	13	37	86	25	62	118	28	58	109	15	34	66
-2,0	9	27	64	17	45	88	19	42	81	9	23	48
-3,0	4	16	42	10	29	58	10	26	53	-	13	30
-4,0	-	6	20	-	12	28	-	10	25	-	-	12

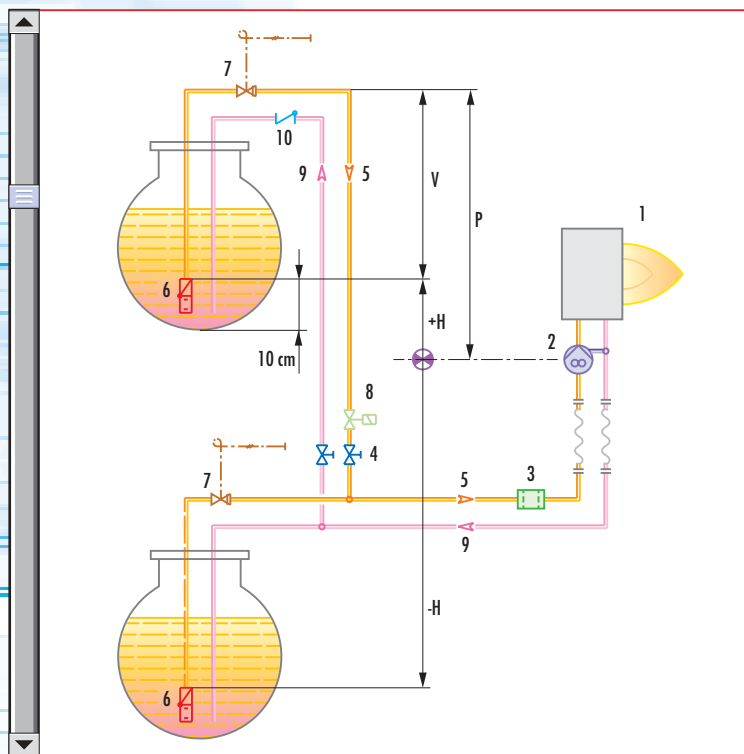

H	Difference in height pump-foot valve
Ø	Internal pipe diameter
P	Height 10 m
V	Height 4 m
1	Burner
2	Burner pump
3	Filter
4	Manual shut off valve
5	Suction pipework
6	Bottom valve
7	Remote controlled rapid manual shut off valve (compulsory in Italy)
8	Type approved shut off solenoid valve (compulsory in Italy)
9	Return pipework
10	Check valve

**note** With ring distribution oil systems, the feasible drawings and dimensioning are the responsibility of specialised engineering studios, who must check compatibility with the requirements and features of each single installation.



## VENTILATION

The ventilation circuit of PRESS burners is inserted in a extremely compact structure and it is provided with a forward blades centrifugal fan, which guarantees high pressure levels at the required air deliveries and permits installation flexibility.

Delivery oil valves opening supplies the adjustable hydraulic ram which regulates air delivery in relation to the fuel burnt on 2nd stage.

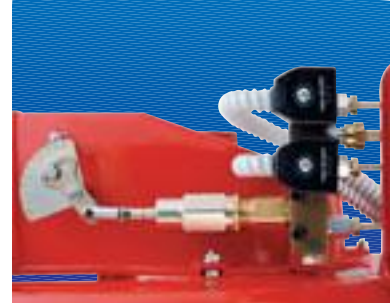

Example of air damper indexed selector and hydraulic ram of PRESS G burners



## COMBUSTION HEAD

For the PRESS G series of burners a special kit for increasing combustion head length is available.

The choice of using it depends on the thickness of the front panel and the type of boiler.

Depending on the type of generator, check that the penetration of the head into the combustion chamber is correct.

The internal position of the combustion head can easily be adjusted to the maximum defined output by adjusting a screw.

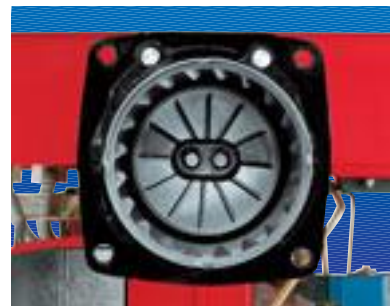

Example of a PRESS G burner combustion head

### Dimensions of the flame

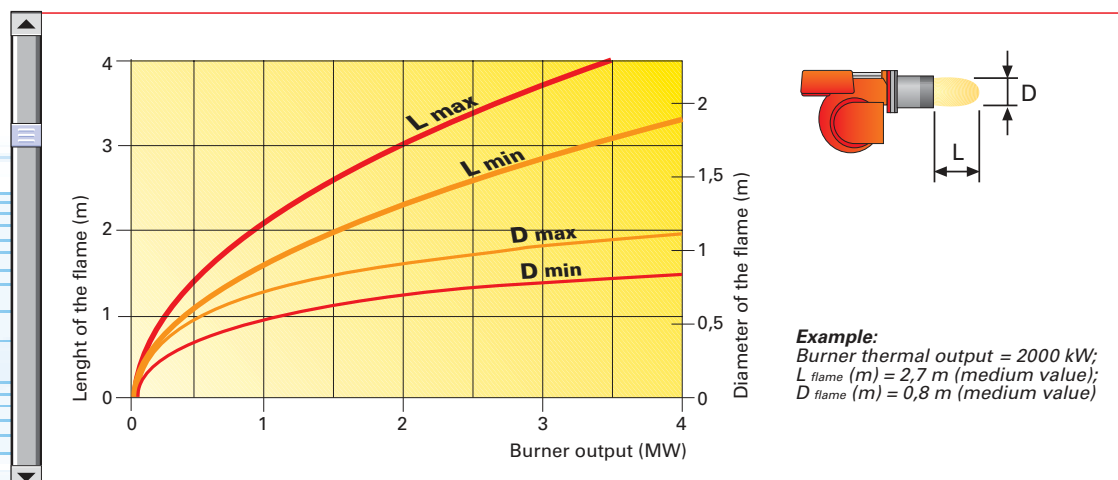

# ADJUSTMENT



## BURNER OPERATION MODE

### Two stage operation

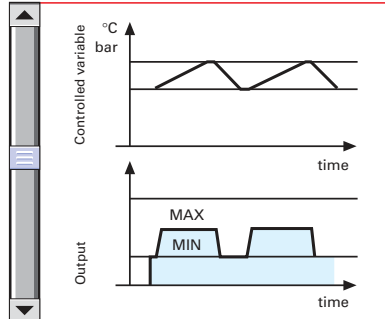

With two stage operation, the PRESS G burners can follow the temperature load requested by the system.

A modulation ratio of 2:1 is reached, thanks to the "two nozzles" technique; the air is adapted to the hydraulic ram positions. On two stage operation, the burner gradually adjusts output to the requested level, by varying between the two pre-set levels (see picture A).

Picture A

All PRESS G series burners are fitted with a new microprocessor control panel for the supervision during intermittent operation.

For helping the commissioning and maintenance work, there are two main elements:



The lock-out reset button is the central **operating element** for resetting the burner control and for activating / deactivating the diagnostic functions.



The multi-color LED is the central **indication element** for visual diagnosis and interface diagnosis.

Both elements are located under the transparent cover of lock-out reset button, as showed below.

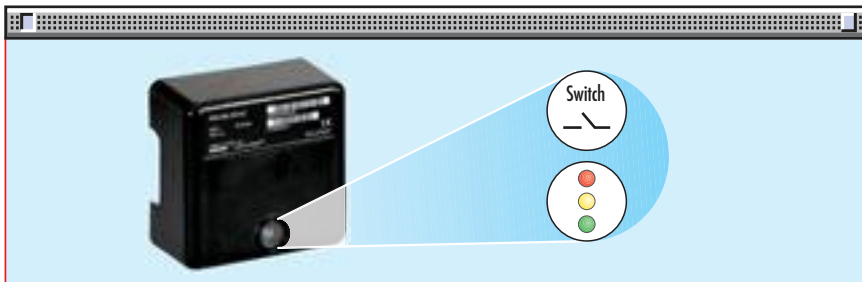

There are two diagnostic choices, for indication of operation and diagnosis of fault cause:

### - visual diagnosis :

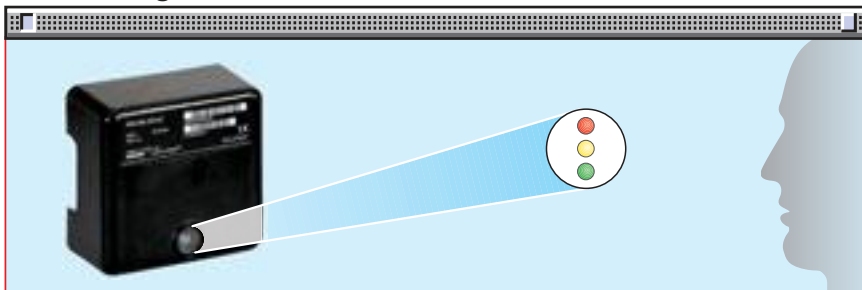

### - interface diagnosis :

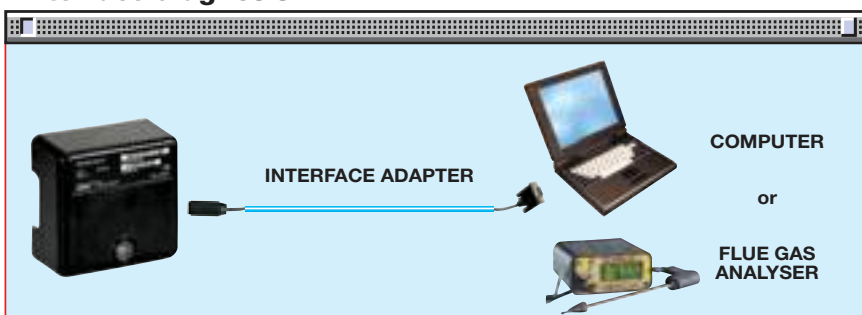

by the interface adapter and a PC with dedicated software or by a predisposed flue gas analyzer (see paragraph accessories).





### Indication of operation :

In normal operation, the various status are indicated in the form of colour codes according to the table below.

The interface diagnosis (with adapter) can be activated by pressing the lock-out button for > 3 seconds.

Color code table	
Operation status	Color code table
Stand-by	○ ○ ○ ○ ○ ○ ○ ○
Pre-purging	☀ ☀ ☀ ☀ ☀ ☀ ☀ ☀
Ignition phase	☀ ○ ☀ ○ ☀ ○ ☀ ○
Flame OK	☘ ☘ ☘ ☘ ☘ ☘ ☘ ☘
Poor flame	☘ ○ ☘ ○ ☘ ○ ☘ ○
Undervoltage, built-in fuse	☀ ☘ ☀ ☘ ☀ ☘ ☀ ☘
Fault, alarm	☘ ☘ ☘ ☘ ☘ ☘ ☘ ☘
Extraneous light	☘ ☘ ☘ ☘ ☘ ☘ ☘ ☘

○ LED off

### Diagnosis of fault causes :

After lock-out has occurred, the red signal lamp is steady on. In this status, the visual fault diagnosis according to the error code table can be activated by pressing the lock-out reset button for > 3 seconds. The interface diagnosis (with adapter) can be activated by pressing again the lock-out button for > 3 seconds.

The flashes of red LED are a signal with this sequence :

(e.g. signal with n° 3 flashes – faulty air pressure monitor)



Error code table	
Possible cause of fault	Flash code
No establishment of flame at the end of safety time : - faulty or soiled fuel valves - faulty or soiled flame detector - poor adjustment of burner, no fuel - faulty ignition equipment	2 flashes ☘ ☘
Faulty air pressure monitor	3 flashes ☘ ☘ ☘
Extraneous light or simulation of flame on burner start up	4 flashes ☘ ☘ ☘ ☘
Loss of flame during operation : - faulty or soiled fuel valves - faulty or soiled flame detector - poor adjustment of burner	7 flashes ☘ ☘ ☘ ☘ ☘ ☘ ☘
Wiring error or internal fault	10 flashes ☘ ☘ ☘ ☘ ☘ ☘ ☘ ☘ ☘ ☘

### START UP CYCLE

PRESS GW - 1G - 2G - 3G - 4G

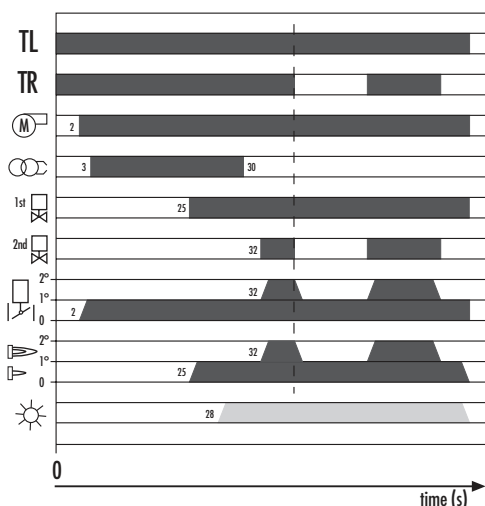

- 0" The control device TL closes.
- 2" The motor starts running.
- 3" The ignition transformer is connected.  
Pre-purging begins with the 1st stage air delivery.
- 25" Firing: 1st delivery valve is opened.
- 30" The ignition transformer switches off; output can be increased to 2nd stage.
- 39" The starting cycle comes to an end.



# WIRING DIAGRAMS

Electrical connections must be made by qualified and skilled personnel, according to the local norms.



## TWO STAGE OPERATION

### PRESS GW single-phase electrical connection

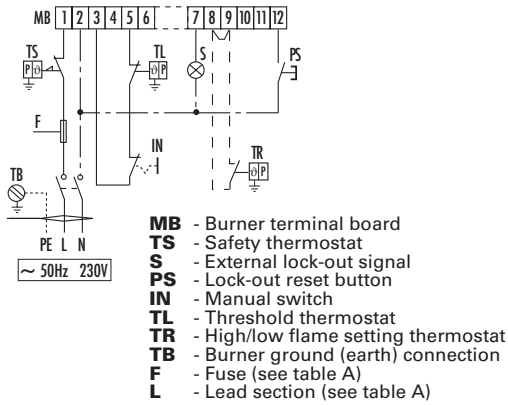

### PRESS 1G - 2G - 3G - 4G three-phase electrical connection

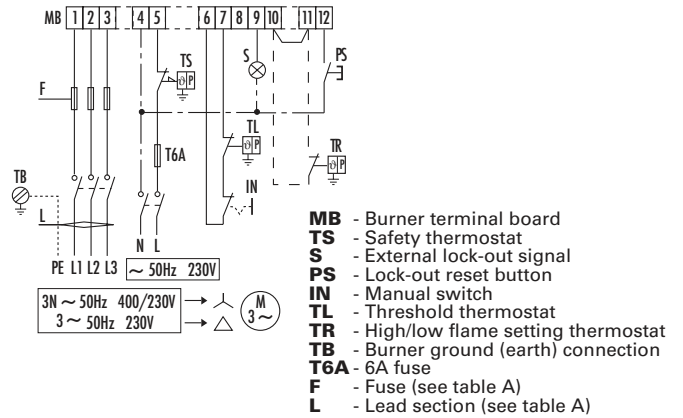

The following table shows the supply lead sections and the type of fuse to be used.

Table A

Model	▼ PRESS GW	▼ PRESS 1G		▼ PRESS 2G		▼ PRESS 3G		▼ PRESS 4G	
	230V	230V	400V	230V	400V	230V	400V	230V	400V
F A	gG6	T6	T6	T6	T6	T16	T10	T25	T16
L mm <sup>2</sup>	1,5	1,5	1,5	1,5	1,5	1,5	1,5	2,5	1,5

# EMISSIONS

## NO<sub>2</sub> EMISSIONS

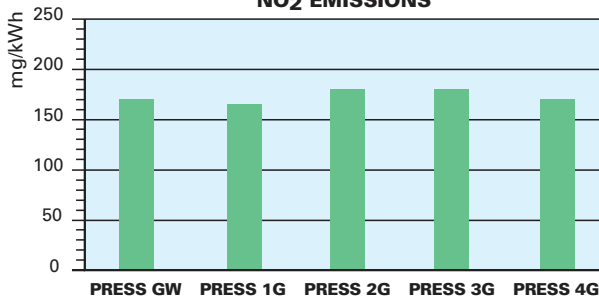

## CO EMISSIONS

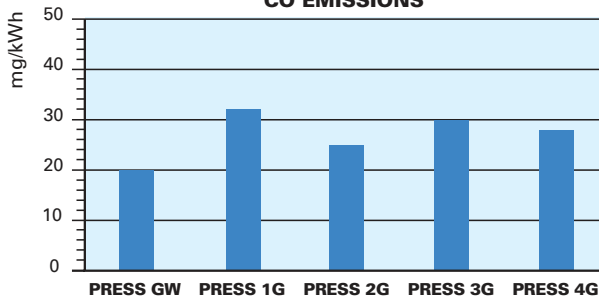

## NOISE EMISSIONS

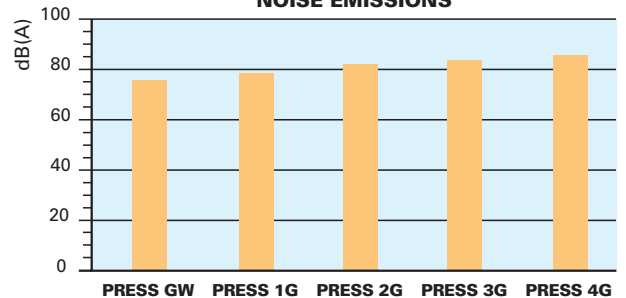

The emission data has been measured in the various models at maximum output, conforming to EN 267 standard.





## OVERALL DIMENSIONS (mm)



### BURNER

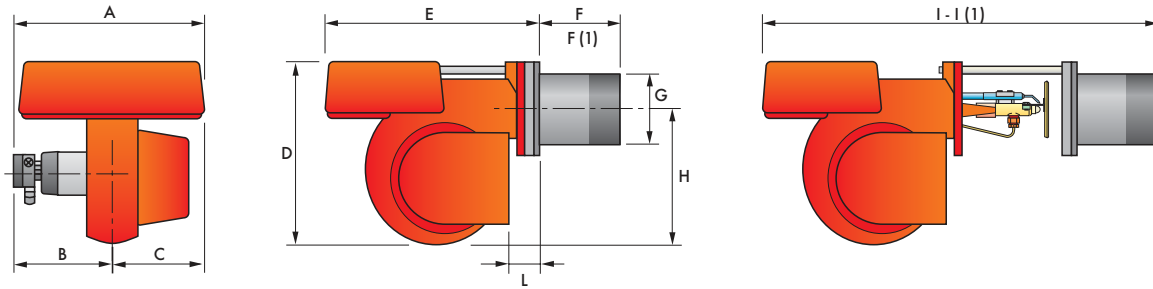

Model	A	B	C	D	E	F - F (1)	G	H	I - I (1)	L
▶ <b>PRESS GW</b>	439	234	205	397	473	185 - 320	140	292	930 - 1065	59
▶ <b>PRESS 1G</b>	475	270	205	397	473	237 - 370	150	292	980 - 1115	59
▶ <b>PRESS 2G</b>	475	270	205	437	506	245 - 403	155	332	1030 - 1190	89
▶ <b>PRESS 3G</b>	611	406	205	485	570	254 - 412	175	370	1100 - 1270	88
▶ <b>PRESS 4G</b>	675	354	316	590	720	266 - 426	205	445	1265 - 1425	175

(1) Length with extended combustion head

### BURNER - BOILER MOUNTING FLANGE

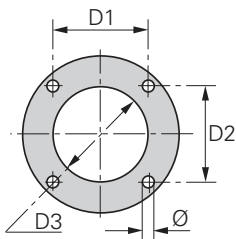

Model	D1	D2	D3	Ø
▶ <b>PRESS GW</b>	160	160	155	M10
▶ <b>PRESS 1G</b>	160	160	165	M10
▶ <b>PRESS 2G</b>	160	160	165	M10
▶ <b>PRESS 3G</b>	195	195	185	M12
▶ <b>PRESS 4G</b>	230	230	210	M12

### PACKAGING

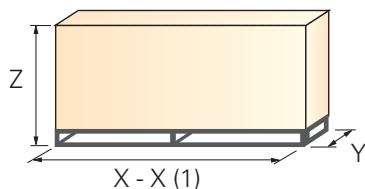

Model	X - X (1)	Y	Z	kg
▶ <b>PRESS GW</b>	695	542	468	37
▶ <b>PRESS 1G</b>	745	542	468	44
▶ <b>PRESS 2G</b>	800	542	515	44
▶ <b>PRESS 3G</b>	905	680	563	55
▶ <b>PRESS 4G</b>	1045	727	660	95

(1) Length with extended combustion head

## INSTALLATION DESCRIPTION

Installation, start up and maintenance must be carried out by qualified and skilled personnel. All operations must be performed in accordance with the technical handbook supplied with the burner.



### BURNER SETTING

- ▶ All the burners have slide bars, for easier installation and maintenance.
- ▶ After drilling the boilerplate, using the supplied gasket as a template, dismantle the blast tube from the burner and fix it to the boiler.
- ▶ Refit the burner casing to the slide bars.
- ▶ Install the nozzles, choosing these on the basis of the maximum boiler output and following the diagrams included in the burner instruction handbook.
- ▶ Check the position of the electrodes.
- ▶ Close the burner, sliding it up to the flange, keeping it slightly raised to avoid the flame stability disk rubbing against the blast tube.
- ▶ Adjust the combustion head.

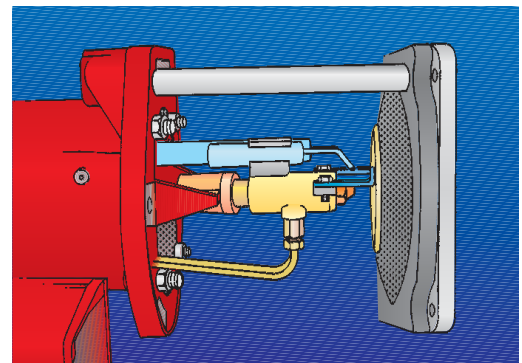
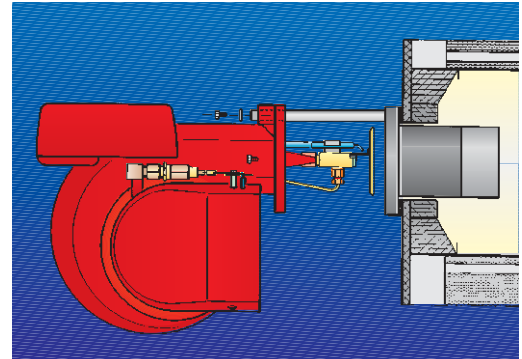

### HYDRAULIC AND ELECTRICAL CONNECTIONS AND START UP

- ▶ The burners are supplied for connection to two pipes fuel supply system.
- ▶ Connect the ends of the flexible pipes to the suction and return pipework using the supplied nipples.
- ▶ Make the electrical connections to the burner following the wiring diagrams included in the instruction handbook.
- ▶ Prime the pump by turning the motor.
- ▶ On start up, check:
  - Pressure pump (to max. and min.)
  - Combustion quality, in terms of unburned substances and excess air.

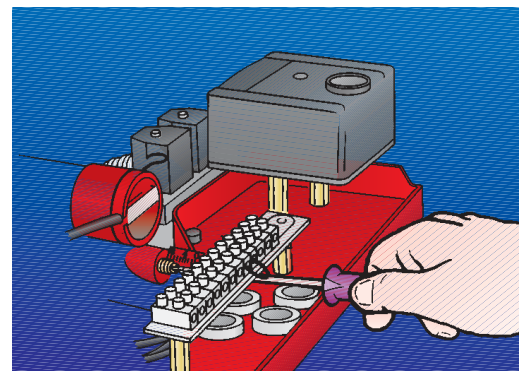



## ACCESSORIES

### Nozzles

The nozzles must be ordered separately. The following table shows the features and codes on the basis of the maximum required fuel output.



Nozzles type 60° B			
Burner	GPH	Rated output (kg/h)*	Nozzle code
PRESS GW - 1G	2,00	8,5	<b>3042126</b>
PRESS GW - 1G	2,50	10,6	<b>3042140</b>
PRESS GW - 1G	3,00	12,7	<b>3042158</b>
PRESS GW - 1G	3,50	14,8	<b>3042162</b>
PRESS GW - 1G - 2G	4,00	17	<b>3042172</b>
PRESS 1G - 2G	4,50	19,1	<b>3042182</b>
PRESS 1G - 2G	5,00	21,2	<b>3042192</b>
PRESS 1G - 2G	5,50	23,3	<b>3042202</b>
PRESS 2G - 3G	6,00	25,5	<b>3042212</b>
PRESS 2G - 3G	6,50	27,6	<b>3042222</b>
PRESS 2G - 3G	7,00	29,7	<b>3042232</b>
PRESS 3G	7,50	31,8	<b>3042242</b>
PRESS 3G	8,00	33,9	<b>3042252</b>
PRESS 3G	8,50	36,1	<b>3042262</b>
PRESS 3G - 4G	9,50	40,3	<b>3042282</b>
PRESS 3G - 4G	10,00	42,4	<b>3042292</b>
PRESS 3G - 4G	11,00	46,7	<b>3042312</b>
PRESS 3G - 4G	12,00	50,9	<b>3042322</b>
PRESS 4G	13,00	55,1	<b>3042332</b>
PRESS 4G	14,00	59,4	<b>3042352</b>
PRESS 4G	15,00	63,6	<b>3042362</b>
PRESS 4G	16,00	67,9	<b>3042382</b>
PRESS 4G	17,00	72,1	<b>3042392</b>
PRESS 4G	18,00	76,4	<b>3042412</b>

(\* ) Nozzles rated delivery is referred to atomised pressure

### Extended head kit

“Standard head” burners can be transformed into “extended head” versions, by using the special kit. The kits available for the various burners, giving the original and the extended lengths, are listed below.

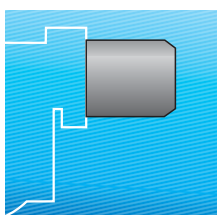

Extended head kit			
Burner	Standard head length (mm)	Extended head length (mm)	Kit code
PRESS GW	185	320	<b>3000581</b>
PRESS 1G	237	370	<b>3000537</b>
PRESS 2G	245	403	<b>3000538</b>
PRESS 3G	254	412	<b>3000851</b>
PRESS 4G	266	426	<b>3000555</b>



### Spacer kit

If burner head penetration into the combustion chamber needs reducing, varying thickness spacers are available, as given in the following table:

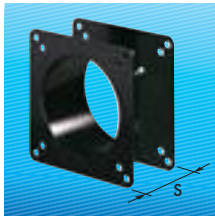

Spacer kit		
Burner	Spacer thickness S (mm)	Kit code
PRESS GW - 1G - 2G - 3G - 4G	142	<b>3000755</b>

### Sound proofing box

If noise emission needs reducing even further, sound-proofing boxes are available, as given in the following table:

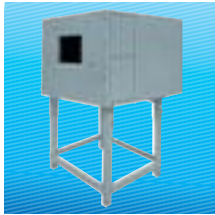

Sound proofing box			
Burner	Box type	Average noise reduction [dB(A)] (*)	Box code
PRESS GW - 1G - 2G - 3G	C1/3	10	<b>3010403</b>
PRESS 4G	C4/5	10	<b>3010404</b>

(\*) according to EN 15036-1 standard

### Degasing unit

With single pipe systems, you can find air in the oil sucked by the pump that comes from the oil itself due to negative pressure or to a faulty seal.

To solve this problem, we recommend fitting a degasing unit near the burner. Two versions are available with or without filter:



Degasing unit		
Burner	Filter	Degasing unit Code
PRESS GW - 1G - 2G - 3G - 4G	With filter	<b>3010055</b>
PRESS GW - 1G - 2G - 3G - 4G	Without filter	<b>3010054</b>

### Air damper complete closure kit

To minimize thermal dispersion caused by the stack draught sucking air from the fan's suction opening, an "air damper complete closure kit" is available.

This is composed by a hydraulic ram, which closes the air damper completely when the burner shuts down.



Air damper complete closure kit	
Burner	Kit code
PRESS GW	<b>3000853</b>
PRESS 1G	<b>3000854</b>
PRESS 2G	<b>3000855</b>
PRESS 3G	<b>3000856</b>
PRESS 4G	<b>3000857</b>

### PC interface kit

To connect the flame control panel to a personal computer for the transmission of operation, fault signals and detailed service information, an interface adapter with PC software are available.



PC interface kit	
Burner	Kit code
PRESS GW - 1G - 2G - 3G - 4G	<b>3002719</b>



## SPECIFICATION

A specific index guides your choice of burner from the various models available in the PRESS G series. Below is a clear and detailed specification description of the product.

### DESIGNATION OF SERIES PRESS BURNERS

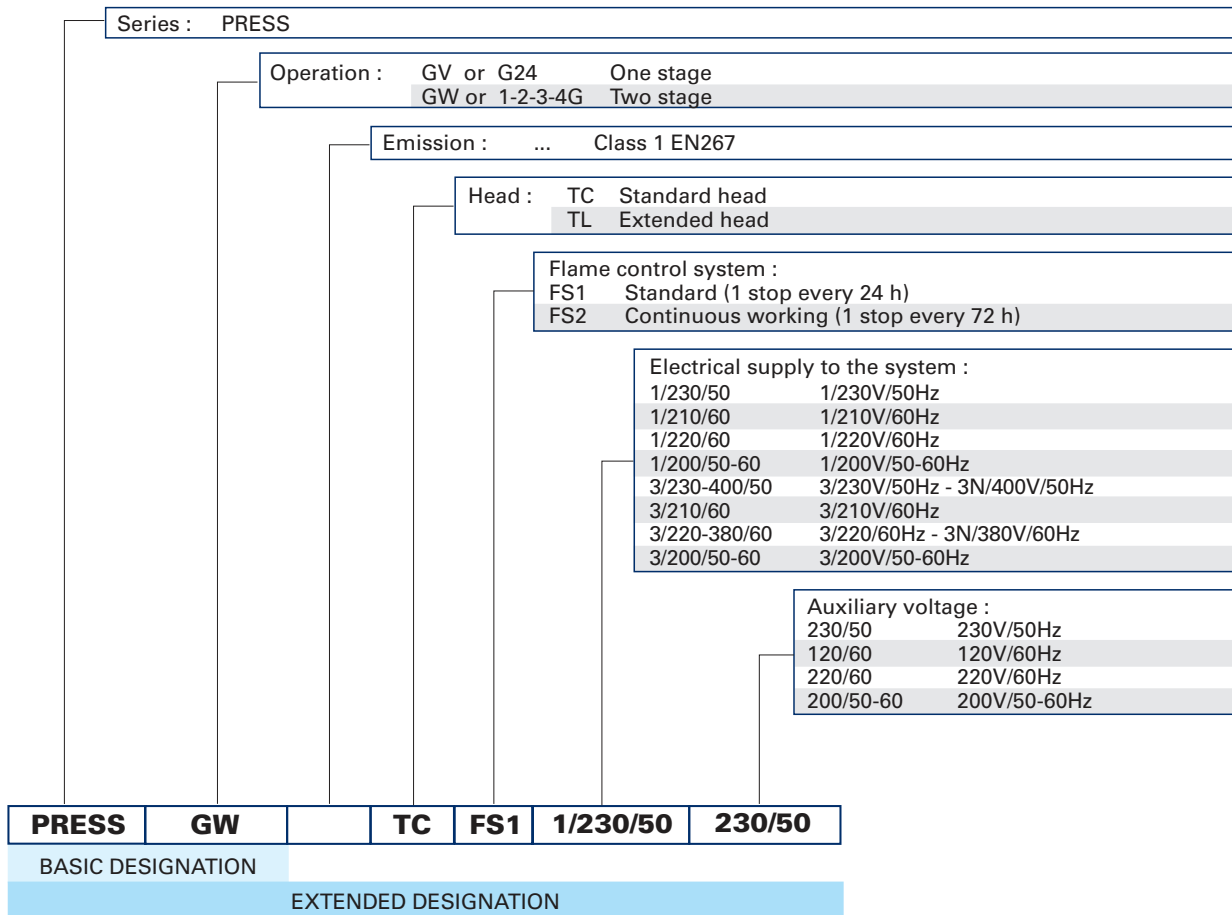

### LIST OF AVAILABLE MODELS

PRESS GW	TC	FS1	3/230-400/50	230/50	(1)	PRESS 3G	TC	FS1	3/200/50-60	200/50-60
PRESS GBW	TC	FS1	1/230/50	230/50		PRESS 3G	TC	FS1	3/230-400/50	230/50
PRESS GW	TC	FS1	1/200/50-60	200/50-60		PRESS 3G	TC	FS1	3/210/60	120/60
PRESS GW	TC	FS1	1/220/60	220/60		PRESS 3G	TC	FS1	3/220-380/60	220/60
PRESS GW	TC	FS1	1/230/50	230/50	(1)	PRESS 3G	TC	FS1	3/230-400/50	230/50 (1)
PRESS GW/35	TC	FS1	1/220/60	220/60						
PRESS 1G	TC	FS1	3/230-400/50	230/50		PRESS 4G	TC	FS1	3/230-400/50	230/50
PRESS 1G	TC	FS1	3/200/50-60	200/50-60		PRESS 4G	TC	FS1	3/200/50-60	200/50-60
PRESS 1G	TC	FS1	1/210/60	120/60		PRESS 4G	TC	FS1	3/220-380/60	220/60
PRESS 1G	TC	FS1	3/210/60	120/60		PRESS 4G	TC	FS1	3/230-400/50	230/50 (1)
PRESS 1G	TC	FS1	3/220-380/60	220/60						
PRESS 1G	TC	FS1	3/230-400/50	230/50	(1)					
PRESS 2G	TC	FS1	3/230-400/50	230/50						
PRESS 2G	TC	FS1	3/200/50-60	200/50-60						
PRESS 2G	TC	FS1	1/210/60	120/60						
PRESS 2G	TC	FS1	3/210/60	120/60						
PRESS 2G	TC	FS1	3/220-380/60	220/60						
PRESS 2G	TC	FS1	3/230-400/50	230/50	(1)					

**(1) Available also in bio diesel fuel version  
Other versions are available on request.**



## ▶ PRODUCT SPECIFICATION

### **Burner:**

Monoblock forced draught oil burner with two stage operation, fully automatic, made up of:

- Air suction circuit lined with sound-proofing material
- Fan with forward curve blades with high performance concerning pressure and air delivery
- Air damper for air setting
- Hydraulic ram for air damper control
- Starting motor at 2800 rpm, three-phase 400V with neutral, 50Hz (single-phase, 230V and 50Hz for the PRESS GW model)
- Combustion head, that can be set on the basis of required output, fitted with:
  - stainless steel end cone, resistant to corrosion and high temperatures
  - ignition electrodes
  - flame stability disk
- Fan pressure test point
- Gears pump for high pressure fuel supply, fitted with:
  - filter
  - pressure regulator
  - connections for installing a pressure gauge and vacuumeter
  - internal by-pass for single pipe installation
- Valve unit with two delivery oil valves on the output circuit
- Photocell for flame detection
- Microprocessor-based flame control panel, with diagnostic function
- Slide bars for easier installation and maintenance
- Protection filter against radio interference
- IP 44 electric protection level.

### **Conforming to:**

- 89/336/EEC directive (electromagnetic compatibility)
- 73/23/EEC directive (low voltage)
- 92/42/EEC directive (performance)
- 98/37/EEC directive (machinery)
- EN 267 (liquid fuel burners).

### **Standard equipment:**

- 2 flexible pipes for connection to the oil supply network
- 2 gaskets for the flexible pipes
- 2 nipples for connection to the pump
- 4 screws for fixing the burner flange to the boiler
- 1 thermal screen
- Instruction handbook for installation, use and maintenance
- Spare parts catalogue.

### **Available accessories to be ordered separately:**

- Nozzles
- Head extension kit
- Head length reduction kit
- Sound-proofing box
- Degassing unit (with or without filter)
- Air damper complete closure kit
- PC interface kit.





RIELLO S.p.A. - Via Ing. Pilade Riello, 5 - 37045 Legnago (VR) Italy  
Tel. ++39.0442630111 - Fax ++39.044221980

Internet: <http://www.rielloburners.com> - E-mail: [info@rielloburners.com](mailto:info@rielloburners.com)

Since the Company is constantly engaged in the production improvement, the aesthetic and dimensional features, the technical data, the equipment and the accessories can be changed.  
This document contains confidential and proprietary information of RIELLO S.p.A.  
Unless authorised, this information shall not be divulged, nor duplicated in whole or in part.

