

ONE STAGE GAS BURNER

▶ GULLIVER RS SERIES

▶ RS5

160 ÷ 330 kW

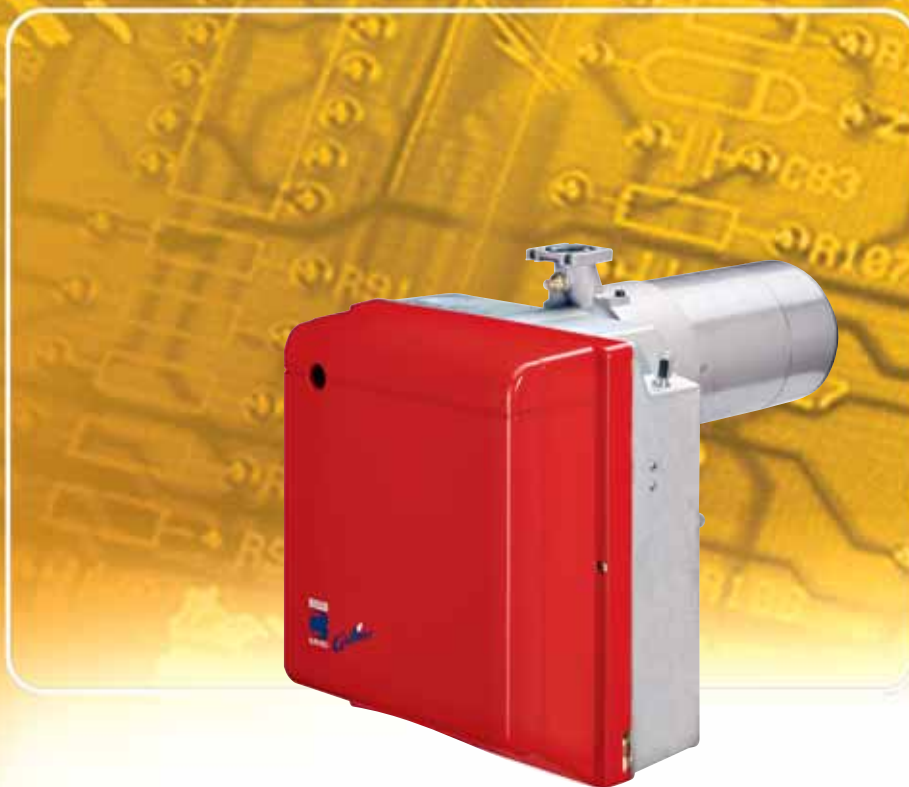

The Riello Gulliver RS5 is a new model of the series of one stage gas burners, characterized for its small dimensions in spite of its high combustion performance. It has been developed to respond to any request for home heating, conforming to current regulations in force. This model uses the same components designed by Riello for the Gulliver series. The high quality level guarantees safe working. The Gulliver RS burners are fitted with a microprocessor - based flame control panel, with diagnostic functions.

In developing this burner, special attention was paid to reducing noise, the ease of installation and adjustment, to obtaining the smallest size possible to fit into any sort of boiler available on the market.

This model is approved by the EN 676 European Standard and European Directives, Gas Appliance, EMC, Low Voltage, Boiler Efficiency.

The Gulliver RS5 burner is tested before leaving the factory.



TECHNICAL DATA

Model		▼ RS5	
Bumer operation mode		One stage	
Modulation ratio at max. output		--	
Servomotor	type	R.B.L.	
	run time	s	
Heat output	kW	160 - 330	
	Mcal/h	137,6 - 283,8	
Working temperature		°C min./max.	
Net calorific value G20 gas		kWh/Nm ³	
G20 gas density		kg/Nm ³	
G20 gas delivery		Nm ³ /h	
Net calorific value G25 gas		kWh/Nm ³	
G25 gas density		kg/Nm ³	
G25 gas delivery		Nm ³ /h	
Net calorific value LPG gas		kWh/Nm ³	
LPG gas density		kg/Nm ³	
LPG gas delivery		Nm ³ /h	
Fan		type	
Air temperature		max °C	
Electrical supply		Ph/Hz/V	
Auxiliary electrical supply		Ph/Hz/V	
Control box		type	
Total electrical power		kW	
Auxiliary electrical power		kW	
Protection level		IP	
Motor electrical power		kW	
Rated motor current		A	
Motor start up current		A	
Motor protection level		IP	
Ignition transformer		type	
		V1 - V2	
		I1 - I2	
Operation		Intermittent (at least one stop every 24 h)	
Sound pressure		dB (A)	
Sound power		W	
CO emission		mg/kWh	
NOx emission		mg/kWh	
Directive		90/396/EEC, 73/23/EEC, 89/336/EEC, 92/42/EEC, 98/37/EEC	
Conforming to		EN 676	
Certification		CE - 0085 BM0114	

Reference conditions:

Temperature: 20 °C

Pressure: 1013,5 mbar

Altitude: 100 m a.s.l.

Noise measured at a distance of 1 meter.

Since the Company is constantly engaged in the production improvement, the aesthetic and dimensional features, the technical data, the equipment and the accessories can be changed.

This document contains confidential and proprietary information of RIELLO S.p.A. Unless authorised, this information shall not be divulged, nor duplicated in whole or in part.



FIRING RATES

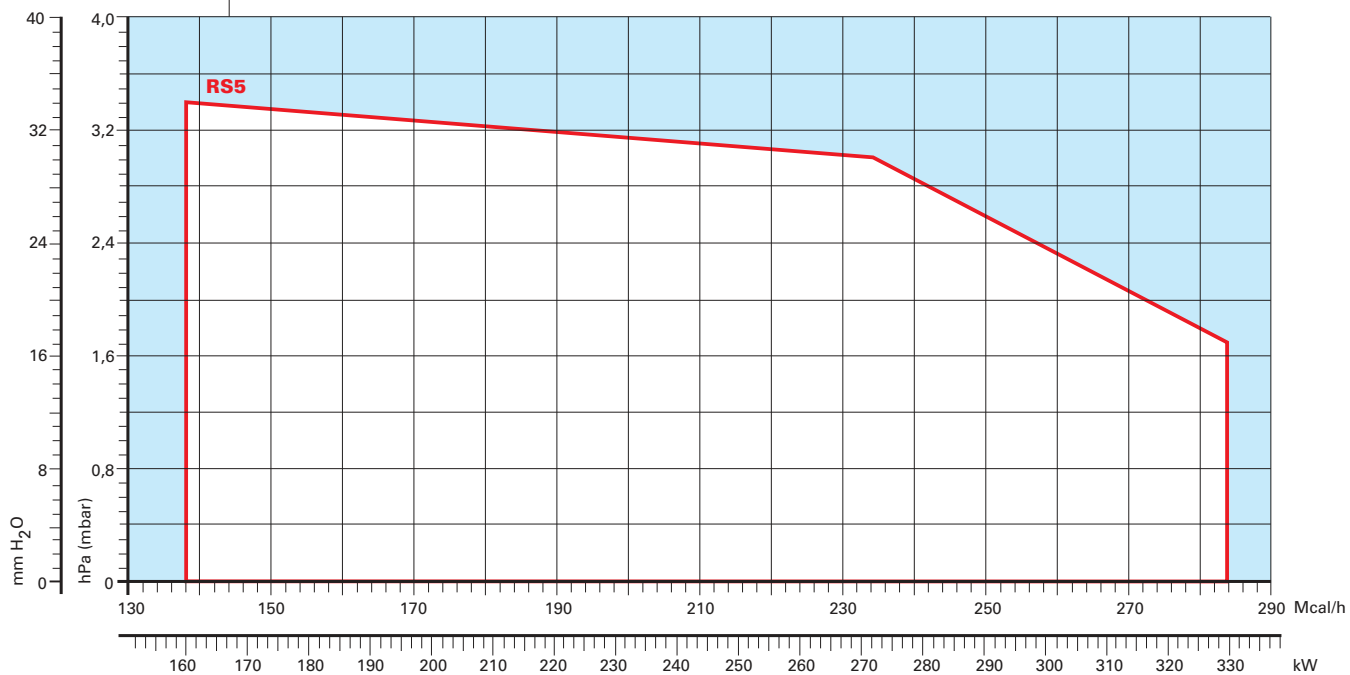

Useful working field for choosing the burner

Test conditions conforming to EN 676:

Temperature: 20°C
Pressure: 1013,5 mbar
Altitude: 100 m a.s.l.





FUEL SUPPLY

GASTRAIN

The burner is set for fuel supply from either the right or left hand sides.

Depending on the fuel output and the available pressure in the supply line, you should check the correct gas train to be adapted to the system requirements.

The gas train is Multibloc type, containing the main components in a single unit, and a valve seal control (as accessory) can be fitted.



Gas train installed on the burner

MBDLE 410 - 412 - 415

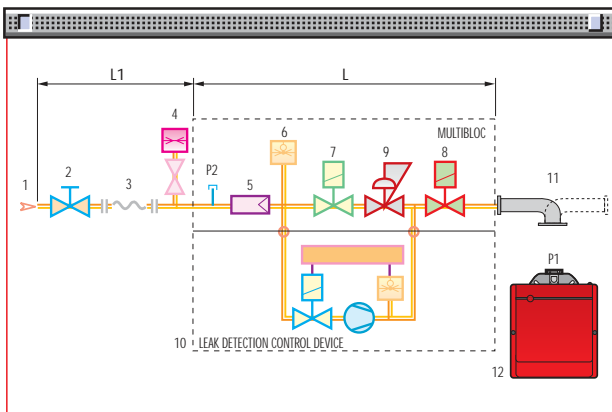

1	Gas delivery pipe
2	Manual valve
3	Vibration damping joint
4	Gas pressure gauge
5	Filter
6	Gas pressure switch
7	Safety solenoid
8	Adjustment solenoid: - firing delivery adjustment (rapid opening) - maximum delivery adjustment (slow opening)
9	Pressure regulator
10	Leak detection control device for valves 7 and 8 (accessory)
11	Gas train-burner adapter
12	Burner
P1	Combustion head pressure
P2	Upstream pressure from the filter
L	Gas train supplied separately
L1	To be performed by the installer

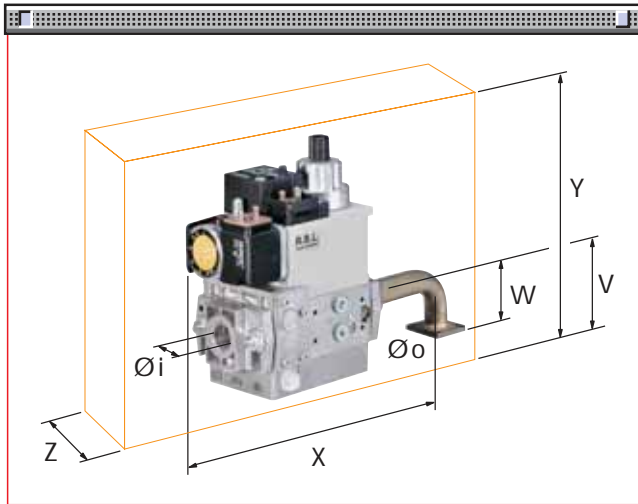

The dimensions of the gas trains vary depending on their construction features. The following table shows the maximum dimensions of the gas trains that can be fitted to Gulliver RS5 burner, intake diameter and the coupling flange to the burner.

	Name	Code	Ø i	Øo	X mm	Y mm	W mm	Z mm	V mm	mbar max*
MULTIBLOC	MBDLE 410	3970549	1" 1/4	FLANGE 3	259	215	47	145	55	300
	MBDLE 412	3970550	1" 1/4	FLANGE 3	259	215	47	145	55	300
	MBDLE 415	3970558	1" 1/2	FLANGE 3	330	250	47	100	80	300

* max inlet gas pressure (mbar)

► PRESSURE DROP DIAGRAM

The diagrams indicate the minimum pressure drop of the burners with the various gas trains that can be combined with them; the value thus calculated represents the minimum required input pressure to the gas train.

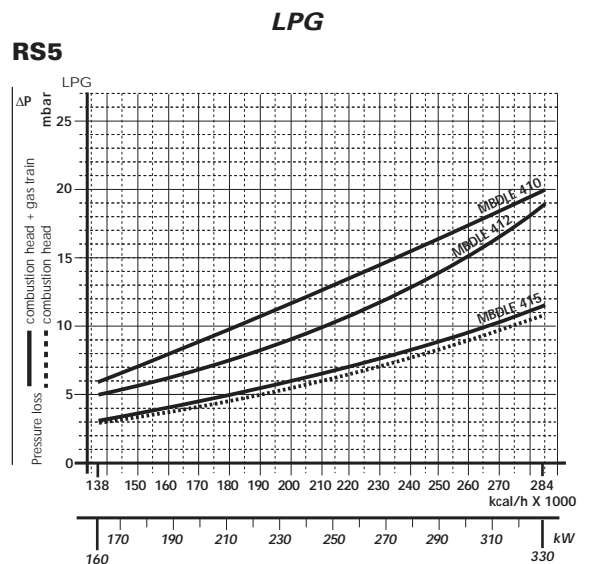
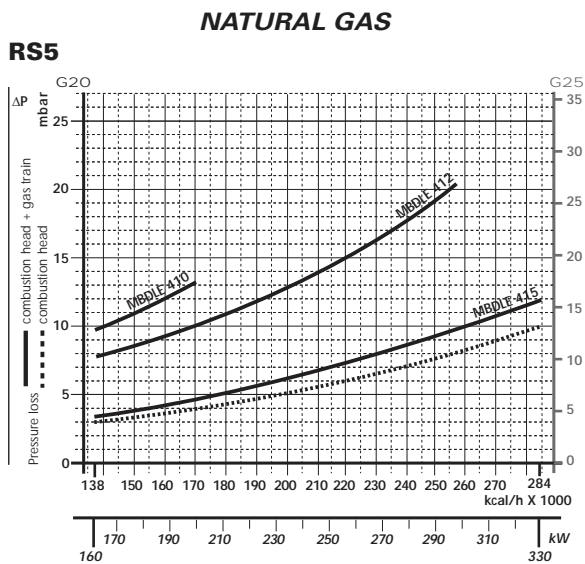

Gas train	Code	Output	Plug and socket
MBDLE 410	3970549	≤200 kW*	•
MBDLE 412	3970550	≤300 kW*	•
MBDLE 415	3970558	-	•

* With natural gas.

► **note** For pressure levels different from those indicated above, please contact Riello Burners Technical Office.
In LPG plants, Multibloc gas trains do not operate below 0°C.
They are only suitable for gaseous LPG (liquid hydrocarbons destroy the seal materials).





SELECTING THE FUEL SUPPLY LINES

The following diagram enables pressure drop in a pre-existing gas line to be calculated and to select the correct gas train.

The diagram can also be used to select a new gas line when fuel output and pipe length are known. The pipe diameter is selected on the basis of the desired pressure drop. The diagram uses methane gas as reference; if another gas is used, conversion coefficient and a simple formula (on the diagram) transform the gas output to a methane equivalent (refer to figure A). Please note that the gas train dimensions must take into account the back pressure of the combustion chamber during operations.

Control of the pressure drop in an existing gas line or selecting a new gas supply line.

The methane output equivalent is determined by the formula fig. A on the diagram and the conversion coefficient.

Once the equivalent output has been determined on the delivery scale (\dot{V}), shown at the top of the diagram, move vertically downwards until you cross the line that represents the pipe diameter; at this point, move horizontally to the left until you meet the line that represents the pipe length.

Once this point is established you can verify, by moving vertically downwards, the pipe pressure drop of on the bottom scale below (mbar).

By subtracting this value from the pressure measured on the gas meter, the correct pressure value will be found for the choice of gas train.

Example:

- gas used G25
- gas output 9.51 mc/h
- pressure at the gas meter 20 mbar
- gas line length 15 m
- conversion coefficient 0.62 (see figure A)

- equivalent methane output $\dot{V} = \left[\frac{9.51}{0.62} \right] = 15.34 \text{ mc/h}$

- once the value of 15.34 has been identified on the output scale (\dot{V}), moving vertically downwards you cross the line that represents 1" 1/4 (the chosen diameter for the piping);
- from this point, move horizontally to the left until you meet the line that represents the length of 15 m of the piping;
- move vertically downwards to determine a value of 1.4 mbar in the pressure drop bottom scale;
- subtract the determined pressure drop from the meter pressure, the correct pressure level will be found for the choice of gas train;

- correct pressure = (20 - 1.4) = 18.6 mbar

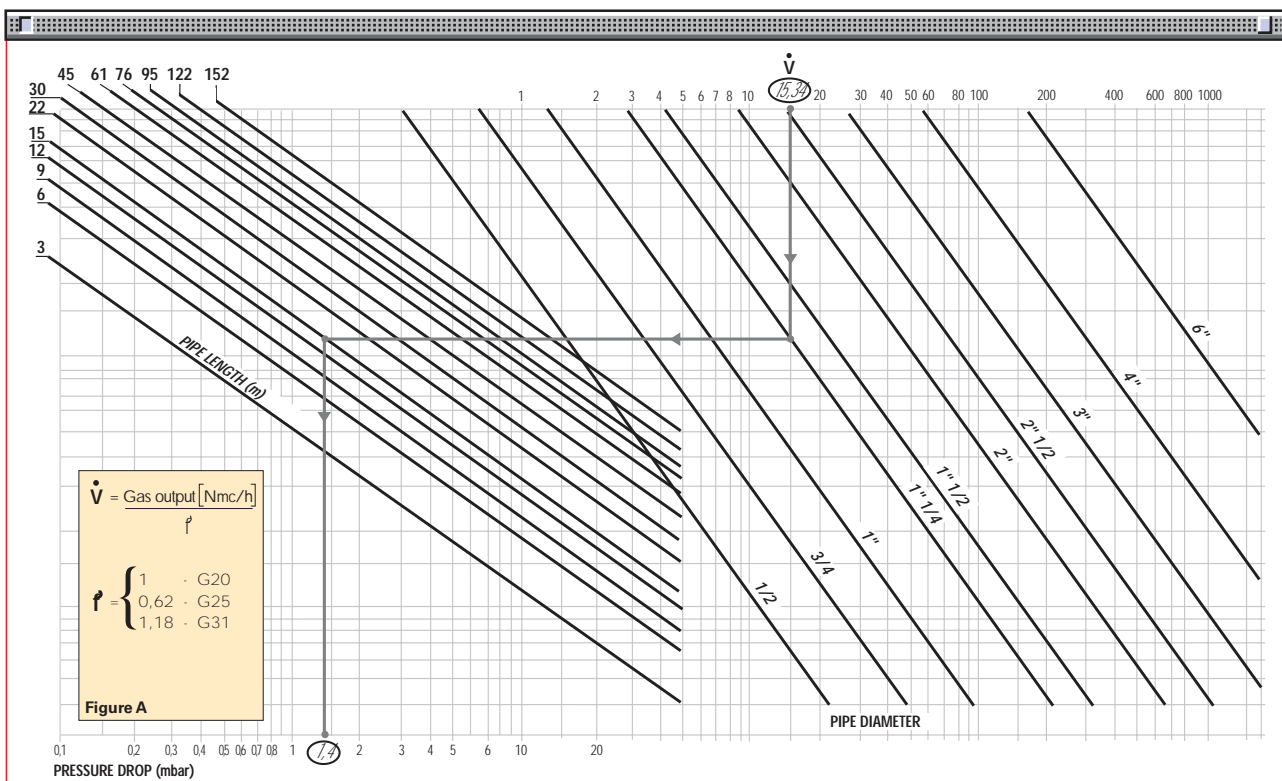

VENTILATION

The ventilation circuit ensures low noise level with high performance of pressure and air delivery, inspite of their compact size.



Air suction

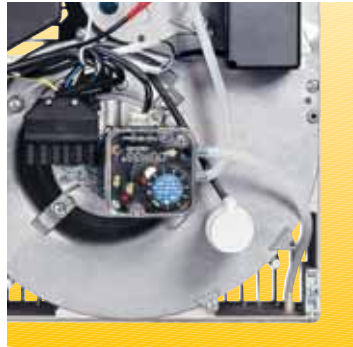

Air pressure switch



The burner is fitted with an adjustable air pressure switch, conforming to EN 676 standards.

COMBUSTION HEAD

The combustion head in Gulliver RS5 burner is the result of an innovative design, which allows combustion with low polluting emissions, while being easy to adapt to all various



Combustion head



Mobile coupling flange

types of boilers and combustion chambers.

Thanks to the use of a mobile coupling flange, the penetration of the head into the combustion chamber can be adjusted.

Simple adjustment allows the internal geometry of the combustion head to be adapted to the burner output.

Dimensions of the flame

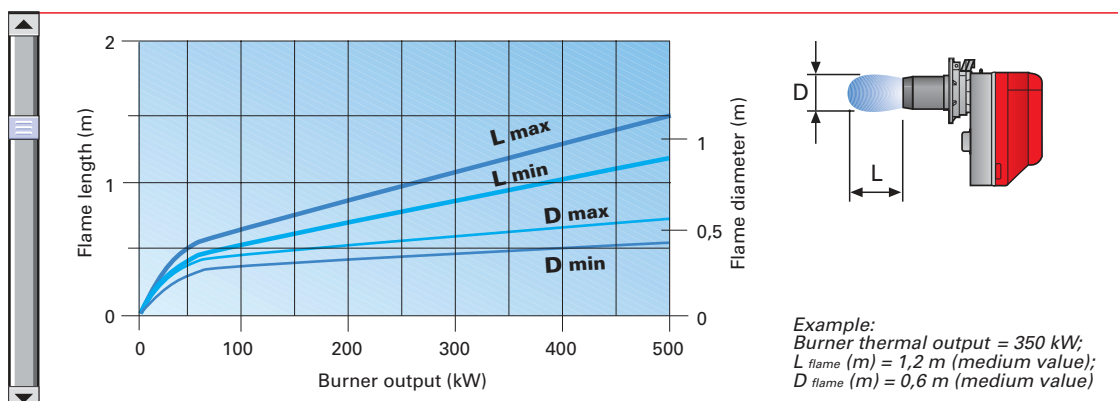



ADJUSTMENT

► BURNER OPERATION MODE

This model has one stage operation.

“One stage” operation

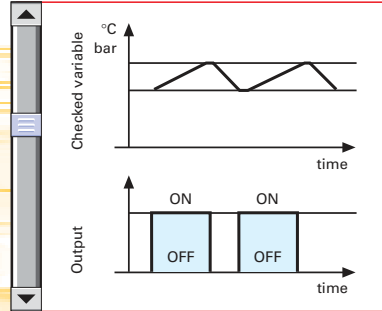

Air damper adjustment

All Gulliver RS series burners are fitted with a new microprocessor control panel for the supervision during intermittent operation.

For helping the commissioning and maintenance work, there are two main elements:



The lock-out reset button is the central **operating element** for resetting the burner control and for activating / deactivating the diagnostic functions.



The multi-color LED is the central **indication element** for visual diagnosis and interface diagnosis.

Both elements are located under the transparent cover of lock-out reset button, as showed below.

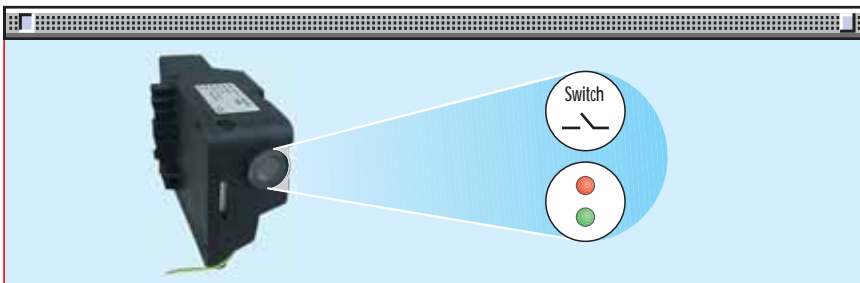

There are two diagnostic choices, for indication of operation and diagnosis of fault cause:

- visual diagnosis :

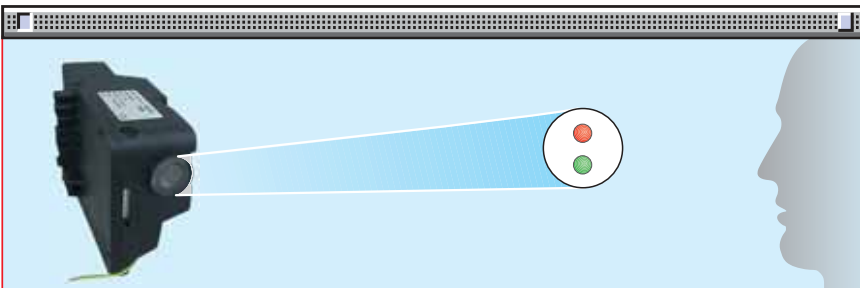

- interface diagnosis :

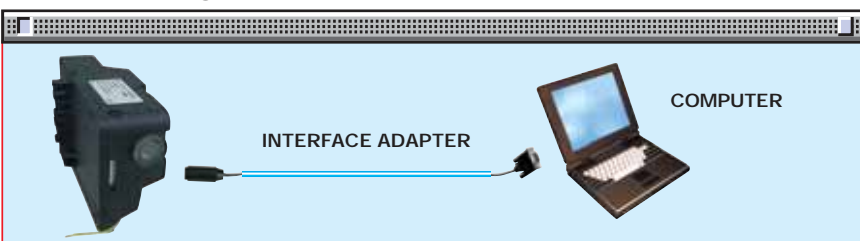

by the interface adapter and a PC with dedicated software.



Indication of operation:

In normal operation, the various statuses are indicated in the form of colour codes according to the table below.

Color code table	
Operation statuses	Color code
Stand-by	○ Led off
Pre-purging	● Green
Ignition phase	● Green
Flame OK	● Green
Post purge	● Green
Undervoltage, built-in fuse	○ Led off
Fault, alarm	● Red

Diagnosis of fault causes:

After lock-out has occurred, the red signal lamp is steady on. In this status, the visual fault diagnosis according to the error code table can be activated by pressing the lock-out reset button for > 3 seconds. The control box sends a sequence of pulses that are repeated at 2-second intervals. The interface diagnosis (with adapter) can be activated by pressing again the lock-out button for > 3 seconds.

Example of blinks sequence:

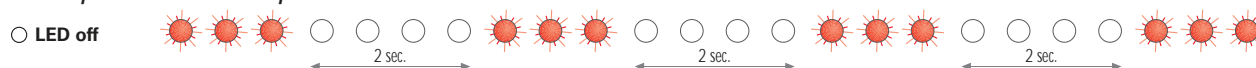

Error code table	
Blink code	Possible cause of fault
2 blinks ● ●	No flame at the end of safety time: - faulty or soiled gas valves - faulty ionisation probe - poor adjustment of burner, no gas - faulty ignition - neutral / phase exchange
3 blinks ● ● ●	Air pressure switch does not close or is already closed before heat demand: - faulty air pressure switch - air pressure switch incorrectly regulated
4 blinks ● ● ● ●	Presence of flame: - in stand-by position - with thermostat of heat demand in idle or working position - during pre-purge - during post-purge
6 blinks ● ● ● ● ● ●	Loss of air pressure: - during pre-purge - during or after safety time
7 blinks ● ● ● ● ● ● ●	Loss of flame during operations after n°3 attempts of re-cycle: - faulty or soiled gas valves - faulty ionisation probe - short circuit between ionisation probe and earth of the burner - poor adjustment of burner, no fuel

The MG569 digital control box gives some other advantages:

Post ignition (during safety time)

The spark ignition is present during all safety time

Adjustable post purge

The Post-purge is a function that maintains air ventilation even after the burner is switched off. Post-purge time can be set to a maximum of 6 minutes.

This function can be activated and set in a very easy way by pressing repeatedly the reset button; after 5 seconds the control box automatically shows the minutes set by the red LED flashing (1 pulse = post-ventilation for 1 minute).

If during post-purge there is a new request for heat, it is halted and a new operating cycle starts. The control box leaves the factory with the setting 0 minutes (no post-ventilation).





Remote lock-out reset

The 'Remote lock-out reset' is a function that allows to reset the control-box operation from a remote position. In the burner packages will be included a particular connector to remote the reset signal. The maximum length of connection must be 20 m.

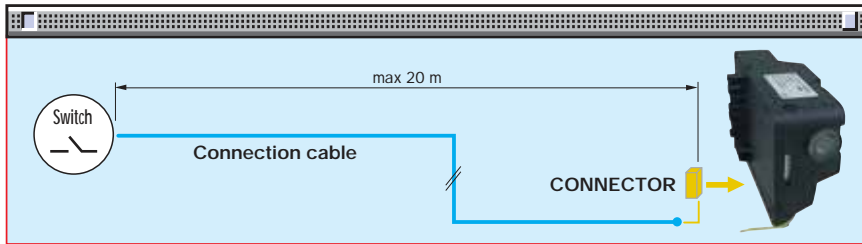

START UP CYCLE

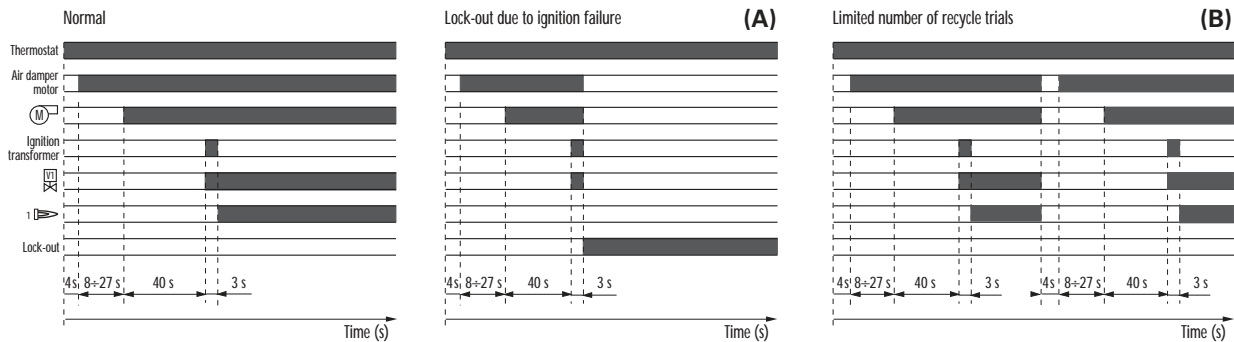

(A) Lock-out is shown by a led on the appliance.

(B) Total number of recycle trials is 3

Correct operation

0s	Start of heat demand the burner begins the ignition cycle
0s-4s	The burner is in stand-by
4s-12/31s	The motor opens the air damper
12/31s-52/71s	Pre-purge with the air damper open
52/71s	Ignition.

Lock-out due to ignition failure

If the flame does not light within the safety limit (~ 3s) the burner locks-out.

Re-cycle

The burner permits maximum three repetitions of complete ignition cycle if there is flame failure during operation.

The burner goes in safety shut-down within one second.

The final action at the last trial following at last flame failure is a lock-out.

WIRING DIAGRAMS



Control - box fitted with ignition transformer

Electrical connections must be made by qualified and skilled personnel, in conformity with the local regulations in force.



▶ "ONE STAGE" OPERATION

Burner electrical wiring

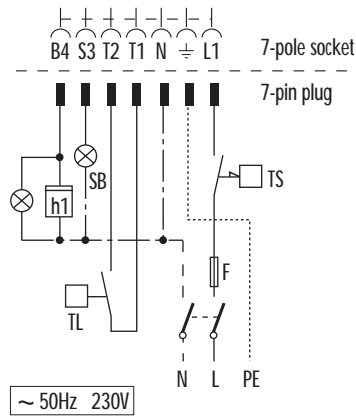

- h1** - One stage hours counter (230V 0,1A max)
- SB** - Remote lock-out signal (230V 0,1A max)
- TL** - Limit thermostat
- TS** - Safety thermostat (manual reset)
- VS** - Safety valve
- V1** - One stage valve
- P** - Gas pressure switch
- F** - Fuse

Gas train electrical wiring

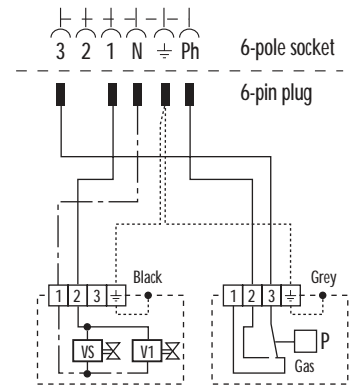

The following table shows the supply lead sections and types of fuse to be used.

Model	▼ RS5
	230V
F A	T6
L mm ²	1

F = Fuse L = Lead section



EMISSIONS

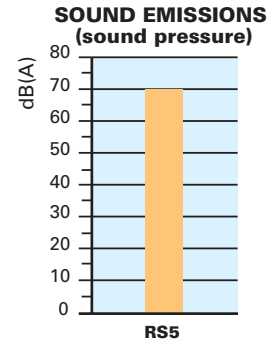
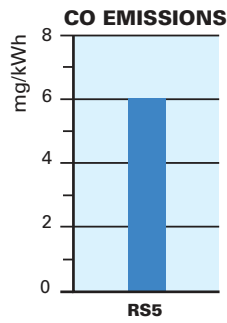
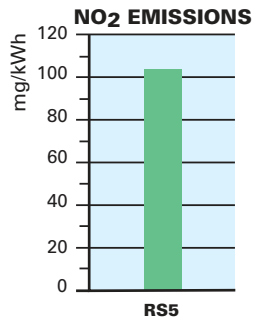

The emission data have been measured in the RS5 at maximum output, in conformity with EN 676 standard.

Special attention has been paid to noise reduction. This model is fitted with sound-proofing material inside the cover.



OVERALL DIMENSIONS (mm)

Thanks to certain construction features, this model can be fitted to any boiler on the market.

BURNER

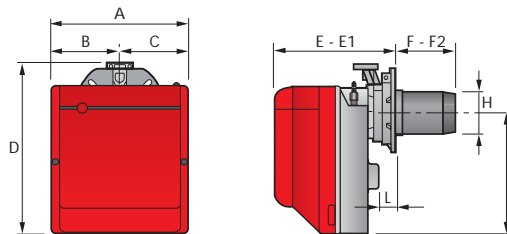

Model	A	B	C	D	E	E1	F	F2	H	I	L
► RS5	300	150	150	392	278	300	203	225	137	286	45

BURNER-BOILER MOUNTING FLANGE

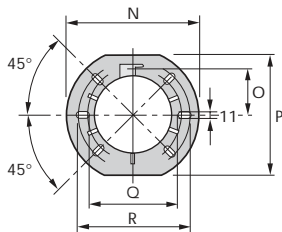

Model	N	O	P	Q	R
► RS5	218	80,5	203	170	200

PACKAGING

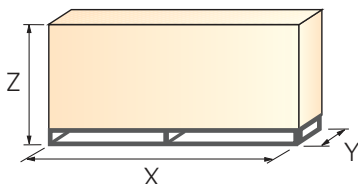

Model	X	Y	Z	kg
► RS5	590	335	420	18

INSTALLATION DESCRIPTION



Installation, start up and maintenance must be carried out by qualified and skilled personnel.

The burner is set in the factory on standard calibration (minimum output), if necessary adjustments can be made on the basis of the maximum output of the boiler.

All operations must be performed as described in the technical handbook supplied with the burner.

- ▶ The mobile flange allows adapting the length of the combustion head to the combustion chamber (flame inversion or 3 smoke cycles) and to the thickness of the boiler panel.

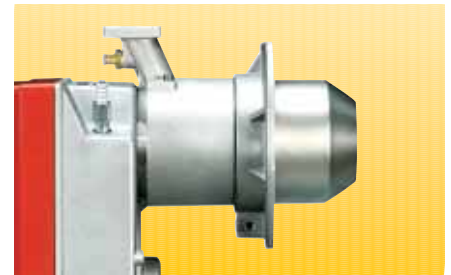

▶ BURNER SETTING

- ▶ The air damper position can be adjusted without removing the burner cover.



- ▶ Head setting is easy and aided by a graduated scale, a test point allows reading the air pressure in the combustion head.



- ▶ Gulliver RS5 burner is fitted with an air pressure switch which, in accordance with EN 676 standards, can be adjusted by the installer using a graduated selector, on the basis of the effective working conditions.



▶ MAINTENANCE AND ELECTRICAL CONNECTIONS

▶ Maintenance is easily solved because the combustion head can be disassembled without having to remove the burner and gas train from the boiler.



▶ The 7-pole socket is incorporated in the control box, the 6-pole socket for connection to the gas train is already connected to the equipment and fixed to the outside of the burner.
The 7-pin plug is also supplied for connection to the boiler.



BURNER ACCESSORIES



Extended head kit

“Standard head” burners can be transformed into “extended head” versions by using the special kit.

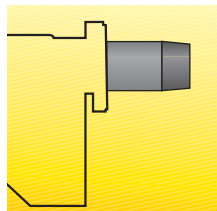

Extended head kit			
Burner	Standard head length (mm)	Extended head length (mm)	Kit code
RS5	203 ÷ 225	357 ÷ 372	3001016

LPG kit

For burning LPG gas, a special kit is available to be fitted to the combustion head on the burner as shown in the following table.

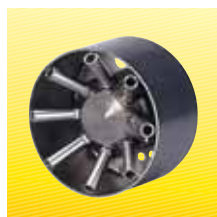

LPG kit		
Burner	Kit code for standard head	Kit code for extended head
RS5	3001011	3001011

Ground fault interrupter kit

A “Ground fault interrupter kit” is available as a safety device in case of electrical system fault. It is supplied with burners with pin plug.



Ground fault interrupter kit	
Burner	Kit code
RS5	3001180

Multibloc rotation kit

There is a special kit available that can be used to install the burner turned 180°. This kit is designed to ensure the gas train valve properly.

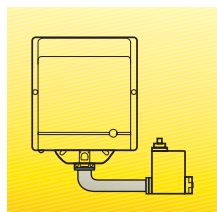

Multibloc rotation kit	
Burner	Kit code
RS5	3001178



7-pin plug kit

If necessary a 7-pin plug kit is available (in packaging of n. 5 pieces).

7-pin plug kit	
Burner	Kit code
RS5	3000945

Interface adapter kit

To connect the flame control panel to a personal computer for the transmission of operation, fault signals and detailed service information, an interface adapter with PC software are available.



Interface adapter kit	
Burner	Kit code
BS1 - BS2 - BS3 - BS4	3002731



GAS TRAIN ACCESSORIES



Seal control kit

To test the valve seals on the gas train, a special "seal control kit" is available.



Seal control kit	
Burner	Kit code
RS5	3010123

SPECIFICATION



A special index guides your choice of boiler according to this model.
Below there is a clear and detailed specification description of the product.

DESIGNATION OF SERIES

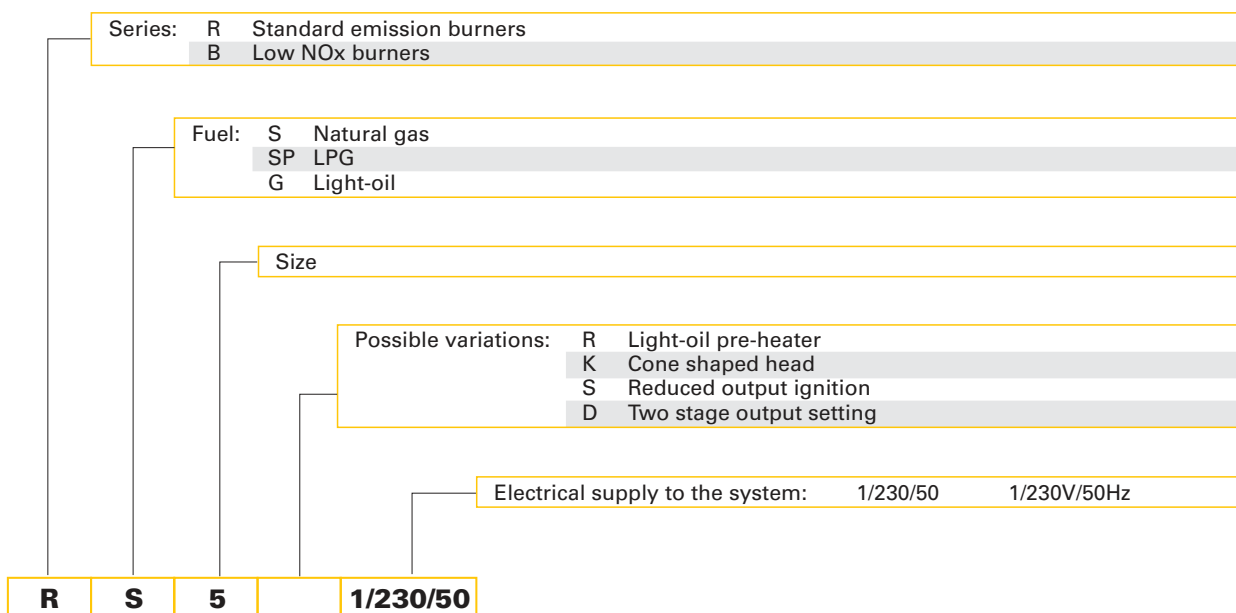

AVAILABLE BURNER MODELS

RS5 1/230/50





▶ **PRODUCT SPECIFICATION**

Burner

Monoblock, gas burner, completely automatic, one stage operation, made up of:

- Fan with forward curve blades
- Cover lined with sound-proofing material
- Air damper, completely closed in stand by, with external adjustment, with no need to remove the cover
- Single phase electric motor 230 V, 50 Hz
- Combustion head fitted with:
 - stainless steel head cone, resistant to high temperatures
 - ignition electrodes
 - ionisation probe
 - gas distributor
 - flame stability disk
- Flame inspection window
- Adjustable air pressure switch, with graduated selector, to guarantee burner lock out in the case of insufficient combustible air
- Microprocessor-based flame control panel, with diagnostic and remote reset functions
- Protection filter against radio interference (included into flame control panel)
- IP X0D (IP 40) electric protection level.

Gas train

Fuel supply line in the Multibloc configuration, fitted with:

- Filter
- Pressure stabiliser
- Minimum gas pressure switch
- Safety valve
- Single stage working valve with ignition gas output regulator.

Approval:

- EN 676 standard.

Conforming to:

- Directive 90/396/EEC (gas)
- Directive 73/23/EEC (low voltage)
- Directive 89/336/EEC (electromagnetic compatibility)
- Directive 92/42/EEC (efficiency)
- Directive 98/37/EEC (machinery).

Standard equipment:

- Sliding flange
- Flange insulation screen
- Screws and nuts for fixing the flange to the boiler
- 7-pin plug
- Remote control release kit
- Instruction handbook for installation, use and maintenance
- Spare parts catalogue.

Available accessories to be ordered separately:

- Extended head kit
- LPG kit
- Ground fault interrupter kit
- Multibloc rotation kit
- 7-pin plug kit
- Interface adapter kit
- Seal control kit.







RIELLO S.p.A. - Via Ing. Pilade Riello, 5 - 37048 San Pietro di Legnago (VR) Italy
Tel. ++39.0442630111 - Fax ++39.044221980

Internet: <http://www.rielloburners.com> - E-mail: info@rielloburners.com

Since the Company is constantly engaged in the production improvement, the aesthetic and dimensional features, the technical data, the equipment and the accessories can be changed.
This document contains confidential and proprietary information of RIELLO S.p.A.
Unless authorised, this information shall not be divulged, nor duplicated in whole or in part.

